

QST

September, 1937

25 cents

devoted entirely to

amateur radio

In this Issue—

**Beam Power
Tubes at Work**

**New Speech
Equipment**

**Avoiding BCL
Interference**



We take this opportunity to show QST readers the new 20C and 12H units. We have "gone modern" in the styling of broadcast equipment and believe that pleasing lines and careful use of color have added something of real value to broadcast stations, where appearance as well as performance is appreciated. The new broadcast equipment caused much favorable comment at the recent NAB Convention where it was exhibited.

Perhaps utility only should be considered in amateur equipment and

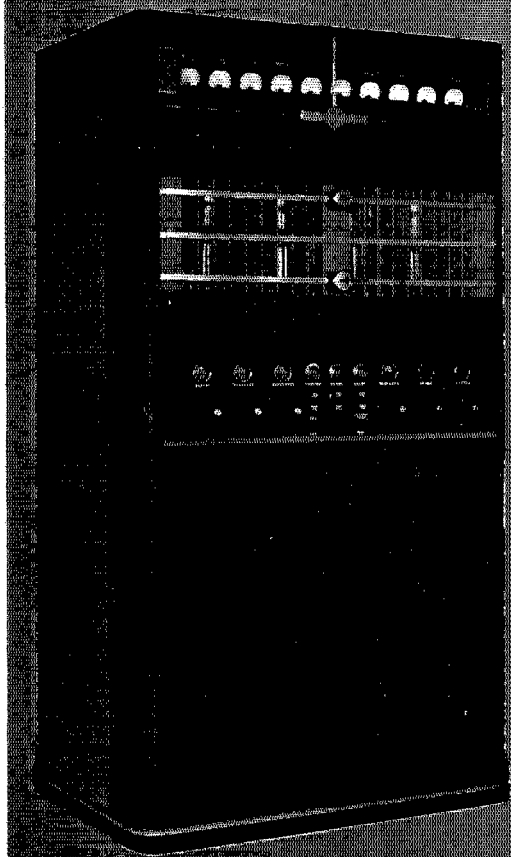

12H SPEECH INPUT ASSEMBLY

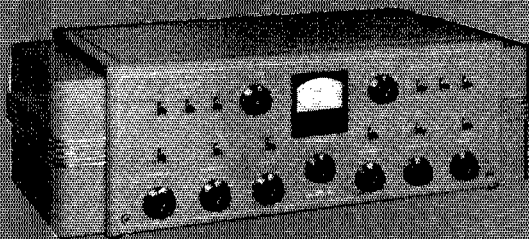

styling should go no further than neatness in mechanical layout. Comments from amateurs would help us decide whether to "stream-line" the new models under development or to adhere to the conventional style used in the past.

COLLINS RADIO COMPANY

C E D A R R A P I D S I O W A

We didn't write this page —



Owners of the New*
1938 SUPER SKYRIDER
did it for us!

● *Says W5APM* "I cannot help but congratulate you on this most wonderful communications receiver. The photos and descriptions of it do not do it full justice. In my opinion it represents the very best value obtainable at any price."
 ● *W1HWZ and W1DFS* add "The audio quality surpasses anything we have ever heard. The band spreading is the best ever. We heard about 15 Five Meter stations and could read most of them on the 'broad' IF position." ● *W9ARA* contributes "I have just received the SX-16 and it is everything I expected it to be. You are going to sell a great many of them." ● From *W3GWP* "V. y. fb. Like it very much 73." ● From the 6th District, J. C. Heath, Salt Lake City, sends this "Think your band spread a remarkable device and the entire set is built like a precision instrument." ● *W2BTP* adds this "Am very pleased with the receiver."

OTHER PROMINENT AMATEURS NOW OPERATING 1938 SUPER SKYRIDERS

W9UZ	W8MNX	W9MSH	W8PLD	W1GCD
W7BJS	W5FCI	W5FZS	W4DLK	W9BLI
W9SJV	W2AQV	VE1KY	W9UHZ	W7CJR
	W8PNN	VE1CA	W1SXT	

WRITE FOR FREE ILLUSTRATED BOOKLET DESCRIBING THE SUPER SKYRIDER AND OTHER HALLICRAFTERS' RECEIVERS

★ These are but a few of the unsolicited comments on the New 1938 Super Sky rider.

All Hallicrafters Receivers now available on Liberal Time Payments.

the hallicrafters inc.

2611 Indiana Avenue, Chicago, Ill. • Cable Address "Hallicraft" Chicago
America's Leading Manufacturer of Communications Receivers

THE SUPER SKY RIDER

It's Phenomenal!



The New 1938 SUPER SKYRIDER

Model S 16
1938
SUPER SKYRIDER
\$99⁰⁰

Model SX 16
Same as above but
with crystal
\$111⁰⁰

Matched Speaker
(P.M. Dynamic)
\$12⁰⁰

Above receivers complete with tubes. All receivers sold on liberal time payments. Orders shipped anywhere in the United States.

● In our twelve years of serving as headquarters to New England amateurs, we have never seen a summer like the one just past. Business has grown to a record breaking proportion, all due to the amazingly New 1938 SUPER SKYRIDER. The performance, the appearance, and the very reasonable price of this receiver certainly justify its popularity. We consider it the most phenomenal receiver in the communications field. So that you may acquaint yourself with the 1938 SUPER SKYRIDER, we urge you to come in and see it — take it out and operate it. Compare it with any other receiver on the market.

Our aim is to make everything easy and convenient for you to own a Hallicrafters receiver. We carry a large stock! We arrange remarkably easy payment terms! We give you speedy, intimate, personal service. Remember, here in old Boston, we are New England's oldest amateur supply house, so come in and visit us or send in your order with every assurance that you will be promptly and courteously served.

The RADIO SHACK

46 Brattle Street

BOSTON MASS.
NEW ENGLAND'S OLDEST AMATEUR SUPPLY HOUSE

the hallicrafters inc.

THE SKY CHIEF THE ULTRA SKY RIDER THE SKY BUDDY

THE SKY RIDER COMMERCIAL THE SKY CHALLENGER

QST

devoted entirely to

AMATEUR RADIO

PUBLISHED, MONTHLY, AS ITS OFFICIAL ORGAN, BY THE AMERICAN RADIO RELAY LEAGUE, INC., AT WEST HARTFORD, CONN., U. S. A.; OFFICIAL ORGAN OF THE INTERNATIONAL AMATEUR RADIO UNION

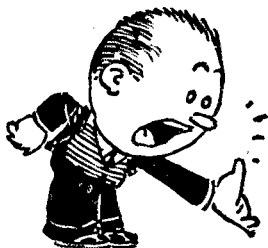

SEPTEMBER

1937

Volume XXI

Number 9



Kenneth B. Warner (Secretary, A.R.R.L.), *Editor-in-Chief and Business Manager*; Ross A. Hull, *Associate Editor*; James J. Lamb, *Technical Editor*; George Grammer, *Assistant Technical Editor*; Clark C. Rodimon, *Managing Editor*; David H. Houghton, *Circulation Manager*; Ralph T. Beaudin, *Assistant Circulation Manager*; E. Cheyney Beekley, *Advertising Manager*; Charles Brunelle, *Assistant Advertising Manager*.

Editorial and Advertising Offices

38 La Salle Road
West Hartford, Connecticut

Subscription rate in United States and Possessions and Canada, \$2.50 per year, postpaid; all other countries, \$3.00 per year, postpaid. Single copies, 25 cents. Foreign remittances should be by international postal or express money order or bank draft negotiable in the U. S. and for an equivalent amount in U. S. funds.

Entered as second-class matter May 29, 1919, at the post office at Hartford, Connecticut, under the Act of March 3, 1879. Acceptance for mailing at special rate of postage provided for in section 1103, Act of October 3, 1917, authorized September 9, 1922. Additional entry at Concord, N. H., authorized February 21, 1929, under the Act of February 28, 1925.

Additional second-class entries to cover sectional editions authorized March 20, 1935. Copyright 1937 by the American Radio Relay League, Inc. Title registered at United States Patent Office.

The Contents

Editorials	7
The Fourth C.C.I.R. at Bucharest Paves Way for Cairo <i>James J. Lamb, W1AL and John C. Stadler, VE2AP</i>	8
Pick Your Spot on the Neighbors' Supers <i>George Grammer</i>	12
A 50-Watt C.W.-Phone Transmitter for 220-Volt D.C. <i>M. P. Mims, W5BDB</i>	14
Modes of Fracture in Piezo-Electric Crystals <i>Edward W. Sanders, W3AKU</i>	17
Beam Tubes in a Push-Pull Amplifier <i>Clark C. Rodimon, W1SZ</i>	19
What the League Is Doing	22
Headset Earcaps for Smoothing Out Frequency Response	23
A New Quartz Crystal Filter for Wide-Range Selectivity <i>Dana H. Bacon, W1BZR</i>	24
Class-B Audio Driver Considerations <i>Douglas Fortune, W9UVC</i>	26
A Six-Band Three-Tube Transmitter <i>A. H. Riesmeyer, W8CHT</i>	28
Circuit Equalizing to Improve Receiver Performance <i>John Gluck, W8MYB</i>	31
Adding Super-Regeneration to an SW3 <i>Byron Goodman, W1JPE</i>	33
With the Affiliated Clubs	34
How Would You Do It?	35
An Electronic Volume Compressor <i>R. E. Bullock, W6MKP and Harry N. Jacobs</i>	37
Central Division Convention	38
Midwest Division Convention	38
Army-Amateur Radio System Activities	39
A Multi-Use Meter for the Amateur Station <i>Herbert W. Gordon, W1IBY</i>	40
An A.V.C.-Controlled Pre-Amplifier <i>James Hanson, W2IGL</i>	42
The 1937 VK-ZL Contest <i>L. G. Petrie</i>	44
Developments in High-Power U.H.F. Tubes 888, W1-461	45
A Compact Airplane-Type Phone Transmitter with Vibrator Power Supply <i>R. M. Ellis, W9YSA</i>	46
Hudson Division Convention	47
The Canada-U.S.A. Contact Contest Results, 1937 <i>George Cooper, VE3ACI and Fred H. B. Saxon, VE3SG</i>	48
Hints and Kinks	50
Amateur Radio Stations. <i>W1AVJ, W2BCP, W6SN</i>	53
Calls Heard	55
I.A.R.U. News	57
Operating News	59
Correspondence Department	67
A.R.R.L. QSL Bureau	94
Standard Frequency Transmissions	96
Dakota Division Convention	114
Rocky Mountain Division Convention	116
Maritime Division Convention	118
Connecticut State Convention	118
New Tubes for Transmitting <i>1608, 1609, 1610</i>	122
12-Volt RK Tubes Available for Mobile Work	122
Hamads	123
QST's Index of Advertisers.	126

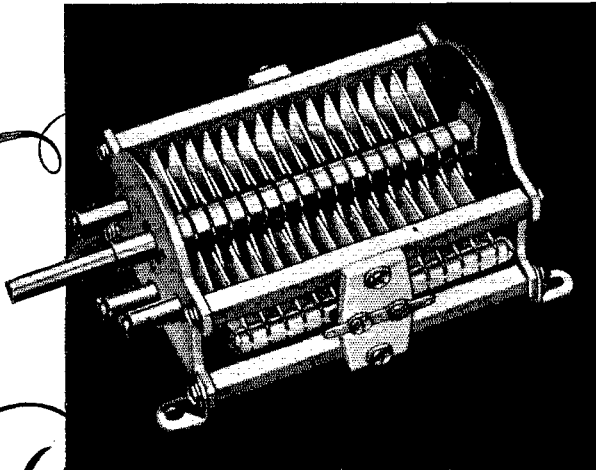

★ New "MTC"
Transmitting
Condenser

Designed FOR TOUGH SERVICE!

WITH the new popular HAMMARLUND "MTC" Transmitting Condensers you are assured of consistent efficiency even under trying operating conditions, for they are specially designed for real tough service!

The "MTC" Transmitting Condensers are made in both single and split-stator styles with the end frames of heavy aluminum sheet. The rotor and stator plates of heavy aluminum are firmly anchored in place by wedging them into deep slots and then by further staking. An accurately ground stainless steel shaft is carefully fitted to a long bronze front bearing mounted on a Beryllium cushion disc. The free floating action thus afforded provides for a perfect bearing and consistently smooth operation.

The rear bearing is of the steel ball and cup type. Isolantite insulation and a silver-plated Beryllium contact wiper assures lowest losses and lowest series resistance. Noiseless operation and complete stability under all conditions guaranteed!

Produced in 19 different sizes — 20 to 500 mmf. — 1000 to 5500 volts — panel or base mounting. Condensers have polished round-edged or standard plates — .025 inches to .040 inches thick. Four base-mounting brackets and three panel-mounting bushings and No. 6-32 screws are packed with each condenser. Prices range from \$2.40 to \$8.50!

You can build a better transmitter with the new "MTC" condensers! For complete details send for the special "MTC" bulletin or the new "37" catalog.

Mail the Coupon Below Today!

HAMMARLUND MFG. CO., INC.
424-438 W. 33rd St., N. Y. City

- Please send me "MTC" bulletin.
 Please send me new "37" catalog.

Name

Address

City State Q-9



HAMMARLUND

Section Communications Managers of the A.R.R.L. Communications Department

All appointments in the League's field organization are made by the proper S.C.M., elected by members in each Section listed. Mail your S.C.M. (on the 16th of each month) a postal covering your radio activities for the previous 30 days. Tell him your DX, plans for experimenting, results in 'phone and traffic. He is interested, whether you are an A.R.R.L. member or get your QST at the newsstands; he wants a report from every active ham. If interested and qualified for O.R.S., O.P.S. or other appointments he can tell you about them, too.

Eastern Pennsylvania
Maryland-Delaware-District
of Columbia
Southern New Jersey
Western New York
Western Pennsylvania

W3EZ
W3BAK
W3BEI
W8DSS
W8OFO

ATLANTIC DIVISION

James M. Bruning
Edgar L. Hudson
W. W. Filson
Charles Smith
Kendall Speer, Jr.

339 W. Lancaster Ave.
247 E. Atlantic Ave.
310 E. Walnut St.

Haverford
Laurel, Delaware
Audubon
Oneda
Lowber

Illinois
Indiana
Kentucky
Michigan
Ohio
Wisconsin

W9KJY
W9QG
W9AUH
W8DPE
W8AQ
W9ATO

CENTRAL DIVISION

L. John Huntoon
Noble Burkhardt
G. W. Mossbarger
Harold C. Bird
E. H. Gibbs
E. A. Cary

327 Brandon Ave.
R. 4, Box 1
Box 177
R.F.D. 2
309 High St.
3922 No. 19th Pl.

Glen Ellyn
Indianapolis
Camp Taylor
Pontiac
Wadsworth
Milwaukee

North Dakota
South Dakota
Northern Minnesota
Southern Minnesota

W9RZA
W9SEB
W9IGZ
W9DCM

DAKOTA DIVISION

Ernest Bloch
Andrew J. Kjar
Edwin L. Wicklund
Webster F. Soules

Box 202
221 West Prospect Ave.
R.F.D. 3
3549 36th Ave., So.

Thompson
Pierre
Kensington
Minneapolis

Arkansas
Louisiana
Mississippi
Tennessee

W5ABI
W5DKR
W5CWO
W4DEP

DELTA DIVISION

H. E. Velte
Eugene H. Treadaway
J. H. Weems, Jr.
B. G. Lowrey Smith

4415 West 12th St.
2749 Myrtle St.
P. O. Box 244
673 Hillcrest St.

Little Rock
New Orleans
State College
Memphis

Eastern New York
N. Y. C. & Long Island
Northern New Jersey

W2LIU
W2AZV
W2GMN

HUDSON DIVISION

Robert E. Haight
E. L. Baunach
Fred C. Read

511 South Holmes St.
102 Central Ave.
1014 North Ave.

Scotia
Massapequa, L. I.
Elizabeth

Iowa
Kansas
Missouri
Nebraska

W9NNM
W9PB
W9CJR
W9FAM

MIDWEST DIVISION

Owen Williams
Harry E. Lepler
J. Dewey Mills
Samuels C. Wallace

108 No. Johnson St.
304 Miami St.
Box 205
Green St.

Iowa City
Hiawatha
Mount Vernon
Clarks

Connecticut
Maine
Eastern Massachusetts
Western Massachusetts
New Hampshire
Rhode Island
Vermont

W1CTI
W1FBJ
W1ABG
W1JAH
W1BFT
W1HRC
W1GNF

NEW ENGLAND DIVISION

Frederick Ellis, Jr.
Winfield A. Ramsdell
Albert N. Giddis
William J. Barrett
Carl B. Evans
Clayton C. Gordon
Alvin H. Battison

19 Merrill Rd.
1188 Washington Ave.
128 Crawford St.
239 Columbia St.
80 No. State St.
192 Washington Ave.
1 Central St.

Norwalk
Portland
Lowell
Adams
Concord
Providence
Windsor

Alaska
Idaho
Montana
Oregon
Washington*

K7PO
W7EMT
W7CRH
W7AJV
W7RL

NORTHWESTERN DIVISION

Richard J. Fox
Carl Eichelberger
Russell U. Richmond
Eugene E. Lovejoy
J. A. Sparks

Box 301
2810 North 6th St.
5013 N. E. Clackamas
R.F.D. 4, Box 150U

Ketchikan
Boise
Somers
Portland
Vancouver

Hawaii
Nevada
Santa Clara Valley
East Bay
San Francisco
Sacramento Valley
Philippines
San Joaquin Valley

K6AJA
W6BIC
W6FBW
W6JTV
W6SG
W6GZY
K6IGR
W6LPE

PACIFIC DIVISION

Otis Hill
Edward W. Heim
Elbert Amarantes
Harold J. Burchfield
Alan D. Whittaker, Jr.
J. L. C. Buckenham
George L. Rickard
Angelo V. Astone

Box 952
509 Claremont St.
454 Washington St.
2240 106th Ave.
79 Elinor Ave.
2931-24th St.
Box 849
729 Safford

Hilo
Reno
San Jose
Oakland
Mill Valley
Sacramento
Manila
Fresno

North Carolina
South Carolina
Virginia
West Virginia

W4OG
W3UVA
W8KKG

ROANOKE DIVISION

H. S. Carter
Charles M. Waff, Jr.
Dr. Wm. H. Riheldaffer

P. O. Box 111
2914 Monument Ave.

Winston-Salem
Richmond
Lost Creek

Colorado
Utah-Wyoming

W9FA
W7COH

ROCKY MOUNTAIN DIVISION

Glen Glasscock
Townsend J. Rigby

2164 So. Corona St.

Denver
Midwest, Wyoming

Alabama
Eastern Florida*
Western Florida
Georgia-Cuba-Isle-of-Pines-
Porto Rico-Virgin Islands

W4DGS
W4DVO
W4BSJ
*W4PM

SOUTHEASTERN DIVISION

James F. Thompson
L. A. Connolly
Ellis R. Curry
Charles W. Davis

102 Narrow Lane Rd.
712 S. Edison Ave.
Box 425
2136 N E Boulevard Dr.

Montgomery
Tampa
Madison
Atlanta, Ga.

Los Angeles
Arizona
San Diego

W6GXW
W6LVG
W6EOP

SOUTHWESTERN DIVISION

Don M. Draper
C. C. Day
Harry A. Ambler

4421 West 63 St.
"La Posta Quemada"
731 York St.

Los Angeles
Vail
Mission Beach

Northern Texas
Oklahoma
Southern Texas
New Mexico

W5DXA
W5CEZ
W5BHI
W5CGJ

WEST GULF DIVISION

Lee Hughes
Carter L. Simpson
Ammon O. Young
Joseph M. Eldout

125 N. Main St.
2010 So. 4th St.
4803 Eli St.

Childress
Ponca City
Houston
Chamita

Maritime

VE1DQ

MARITIME DIVISION

A. M. Crowell

69 Dublin St.

Halifax, N. S.

Ontario

VE3SG

ONTARIO DIVISION

Fred H. B. Saxon

302 Lee Ave.

Toronto, Ont.

Quebec

VE2EE

QUEBEC DIVISION

Stan Comach

780 Brault Ave.

Verdun, P. Q.

Alberta
British Columbia

VE4LX
VE5EP

YANALTA DIVISION

Alfred D. Kettenbach
D. R. Vaughan-Smith

1221 Burnaby St.

Rockyford
Vancouver

Manitoba
Saskatchewan

VE4BG
VE4EL

PRAIRIE DIVISION

A. J. R. Simpson
Wilfred Skaife

635 Garfield St.
2040 McTavish St.

Winnipeg
Regina

* Officials appointed to act until the membership of the Section choose permanent S.C.M.'s by nomination and election.

The American Radio Relay League



DIRECTORS

President
EUGENE C. WOODRUFF.....W8CMP
234 W. Fairmount Ave., State College, Pa.

Vice-President
GEORGE W. BAILEY.....W1KH
74 Webster Road, Weston, Mass.

Canadian General Manager
ALEX REID.....VE2BE
169 Logan Ave., St. Lambert, P. Q.

Atlantic Division
WALTER BRADLEY MARTIN.....W3QV
Box 612, Roslyn, Pa.

Central Division
R. H. G. MATHEWS.....W9ZN
100 East Ohio St., Chicago

Dakota Division
CARL L. JABS.....W9BVH
1822 James St., St. Paul, Minn.

Delta Division
E. RAY ARLEDGE.....W5SI
P. O. Box 286, Pine Bluff, Ark.

Hudson Division
KENNETH T. HILL.....W2AHC
115 Willow St., Douglaston, L. I., N. Y.

Midwest Division
FLOYD E. NORWINE, JR.....W9EFC
120 South Fourth St., St. Louis, Mo.

New England Division
PERCY C. NOBLE.....W1BVR
37 Broad St., Westfield, Mass.

Northwestern Division
RALPH J. GIBBONS.....W7KV
c/o United Air Lines, Pendleton, Ore.

Pacific Division
S. G. CULVER.....W6AN
2962 Russell St., Berkeley, Calif.

Roanoke Division
H. L. CAVENESS.....W4DW
State College Station, Raleigh, N. C.

Rocky Mountain Division
EDWARD C. STOCKMAN.....W9ESA
618 So. Williams St., Denver

Southeastern Division
BENNETT R. ADAMS, JR.....W4APU
1512 Grove Place, Homewood, Ala.

Southern Division
CHARLES E. BLALACK.....W6GG
443 Main St., El Centro, Calif.

West Gulf Division
WAYLAND M. GROVES.....W5NW
c/o Humble Pipe Line, Talco, Texas

THE AMERICAN RADIO RELAY LEAGUE, INC., is a non-commercial association of radio amateurs, bonded for the promotion of interest in amateur radio communication and experimentation, for the relaying of messages by radio, for the advancement of the radio art and of the public welfare, for the representation of the radio amateur in legislative matters, and for the maintenance of fraternalism and a high standard of conduct.

It is an incorporated association without capital stock, chartered under the laws of Connecticut. Its affairs are governed by a Board of Directors, elected every two years by the general membership. The officers are elected or appointed by the Directors. The League is non-commercial and no one commercially engaged in the manufacture, sale or rental of radio apparatus is eligible to membership on its board.

"Of, by and for the amateur," it numbers within its ranks practically every worth-while amateur in the nation and has a history of glorious achievement as the standard-bearer in amateur affairs.

Inquiries regarding membership are solicited. A bona fide interest in amateur radio is the only essential qualification; ownership of a transmitting station and knowledge of the code are not prerequisite. Correspondence should be addressed to the Secretary.

HIRAM PERCY MAXIM, FIRST PRESIDENT

OFFICERS

President.....EUGENE C. WOODRUFF, W8CMP
State College, Pa.

Vice-President.....GEORGE W. BAILEY, W1KH
Weston, Mass.

Secretary.....KENNETH B. WARNER, W1EH
West Hartford, Connecticut

Treasurer.....ARTHUR A. HEBERT, W1ES
West Hartford, Connecticut

Communications Mgr....F. EDWARD HANDY, W1BDI
West Hartford, Connecticut

General Counsel.....PAUL M. SEGAL
1010 Shoreham Building, Washington, D. C.

Address all general correspondence to the administrative headquarters at West Hartford, Connecticut



THE EDITOR'S MILL

IT'S an old story that most radio amateurs of extended experience have been in the game in two or more stretches. Young hams for years, they meet the right girl, start spending their time on front porches instead of in the shack, get married and trade their vacuum tubes for milk bottles, and are gone from the air. Gone for about five years. Then they come back, this time as more or less sedate papas, their talk sprinkled with references to the OW and the kids. And this time they're due for another hashmark for another five-year hitch.

Having felt it in our bones for years that this was about the situation, we have lately received startling verification of it in graphical form. Remember these questionnaires the League sends out to new and renewing members, asking about this and that and particularly about *QST* likes and dislikes? Well, we've been analyzing the returns and they probably show us more about ourselves than we ever knew before.

We learn, for instance, by plotting the number of Class-B amateurs against their ages, that most such amateurs during their first hitch are between 17 and 21 years old. Then the number falls off sharply, not to return to these levels until the age of 28 is attained. From 28 to 33 the figures are again back up to the 17-21 level, showing the return to the air after the young man has got himself established in the world. Beyond the age of 33 the number of amateurs in each age group slowly tapers off. The Class-A group, although a little more evenly distributed, shows similar peaks at 20 and 30 years. Even the Class C has a peak at 20 years. Surprisingly enough, we notice that even the unlicensed members of the League are divided into two "hills," with a deep "valley" in between. All the signs indicate that what might be the smooth tenor of an average amateur's perfect radio life is interrupted by economic and biological considerations in his mid-twenties, sharply dividing us into those serving our first enlistment and those in later hitches.

More League members have been licensed three years than any other number of years, but from that figure onward the curve drops only gradually and smoothly away. Interestingly enough, though, we find some scores of chaps who have belonged to the League since its formation and who have had licenses since the beginning of licenses. Wonder how many separate hitches they served?

The average age of the licensed A.R.R.L. member is 27 years. The figures vary but slightly between the classes of license: 26.78 years for Class C, 27 even for B, 27.18 for A. So if you're a Class-C amateur now and wondering when you'll make the grade for Class A, our answer is that if you're average you're due for it in 0.4 years. Whatever that is.

THE great Marconi has gone to his eternal reward, leaving a complex radio world to grieve at his departure, the amateur no less than the professional. For it was Marconi who first seized upon the separate components of early wireless experimentation and welded them into a practical communicating system, who first made an unbelieving world believe, and whose pioneering work was the foundation upon which amateur radio has grown.

We cannot do better than to quote here the public statement last month of our president, Dr. Eugene C. Woodruff:

"Marconi was a symbol to all radio services, and in particular to the amateur, for he himself partook of so many of the characteristics of the true amateur. Indeed, he was wont to say, 'I myself am an amateur.' Throughout his fruitful lifetime, his was the questing spirit of the typical amateur of radio—seeking to penetrate new frontiers, to pierce the veils of science, to garner new knowledge, not for personal gain or glory but for all humanity. Amateur radio has lost a friend and a patron. Seventy thousand amateurs in all countries of the world mourn his passing."

Vale!

K. B. W.

The Fourth C.C.I.R. at Bucharest Paves the Way for Cairo

I.A.R.U. Representation Obtains Increased Recognition of Amateur Radio

By James J. Lamb,* W1AL, and John C. Stadler,** VE2AP

With some 200 delegates, representatives and staff members of 27 national administrations and five international organizations in attendance, James J. Lamb, W1AL, and John C. Stadler, VE2AP, represented the International Amateur Radio Union at the Fourth C.C.I.R. meeting in Bucharest, Roumania, May 21st to June 8th. As the representatives of amateur radio, it was their purpose to employ their best efforts toward diverting developments which might jeopardize the position of amateur radio, as well as to cooperate and assist in every way possible in the constructive work of the conference in order to earn for amateurs increased recognition of value. That their conduct and their efforts were fruitful is amply shown in the results of the conference related by them in this report.—EDITOR

WITH the big international radio conference at Cairo but a matter of months in the future, the Bucharest meeting of the International Radio Consulting Committee (C.C.I.R., from the initials of its French name) had more than ordinary portent. Although the C.C.I.R. is specifically a consulting committee, as its name indicates, with its field restricted almost entirely to recommending technical practices in radio communication, nevertheless its product of opinions unavoidably carries weight in guiding the deliberation of a subsequent treaty-making conference which will adopt a set of general regulations that will control the destinies of all who engage in radio communication in the years to follow. And among those who will be so affected are we amateurs.

Although there was no direct threat to the amateur position in any of the 20 questions scheduled for consideration at the conference, and only one or two had implications which might affect amateur station operation, several could have brought forth opinions that might affect other services in ways which would generate additional pressure on our amateur assignments. However, the 20 final opinions and 20 new questions which resulted from the conference not only are devoid of direct or implied threats to amateur frequency assignments, but generally evidence a new progressive technical attitude that should improve commercial use of the radio spectrum and thereby relieve the pressure on our assigned bands. Furthermore, in several instances the opinions adopted and the new questions set up for future study show favorably the influence of our technical contributions and work in the conference.

Because of the special significance of this meeting, the A.R.R.L. Board of Directors, at its 1936 annual meeting, voted to underwrite I.A.R.U.

* Technical Editor, *QST*.

** 4334 Westmount Ave., Westmount, P. Q.

participation and designated as representatives the authors of this report, James J. Lamb, W1AL, technical editor of *QST*, and John C. Stadler, VE2AP, of Montreal, Canada. This action was ratified by the Union, and the other national societies, in addition to A.R.R.L., voted to share in the expense of participation.

As has been explained previously in *QST*,¹ the only way in which amateurs can participate in their own name in the C.C.I.R. is through the International Amateur Radio Union, which is one of the international organizations recognized under Article 31 of the Madrid General Radio Regulations. With the exception of these international organizations, only experts of government administrations and radio operating companies or groups of radio operating companies recognized by their respective governments are qualified to participate. Accordingly, representatives of a national radio society, such as the A.R.R.L., could not be admitted.

With Bucharest, the locale of the conference, 1500 miles or more across Europe from the most convenient point of transatlantic debarkation, the opportunity of establishing closer relations between I.A.R.U. Headquarters and as many of the amateur societies as could be conveniently visited was considered. Making such visits as could be arranged was assigned as an additional duty of your two representatives. Travel plans were made accordingly to land at Hamburg and travel to Berlin for a visit with the officials of the D.A.S.D., the German National Society, and to travel on from there to Bucharest by way of Poland, the most economical route. The return route was direct from Bucharest to Paris, by the Simplon Orient Express, where there would be opportunity for a visit and conference with the officials of the French National Society, the R.E.F. From Paris the return trip was scheduled

¹ K. B. Warner and James J. Lamb, "Amateur Radio at the Third C.C.I.R." *QST*, December, 1934.

to continue by way of England for a similar meeting at the R.S.G.B. Headquarters in London, to be followed by the transatlantic voyage back to New York. Along with the visits in Berlin, Paris and London, study of technical developments in radio communication and television also was planned. Although this contemplated program obviously promised to be strenuous and left little opportunity for intervals for relaxation from official work, it was undertaken without hesitancy because the effort involved promised to be well worth while. In a total time of exactly two months, of which three weeks were taken up by attendance at the C.C.I.R. Conference, three weeks were required for travel and the relatively small remainder of two weeks was utilized in this additional work. The actuality realized from this effort exceeded expectation in fruitful results, especially in improving international understanding and in establishing closer personal relations among the member societies

of the Union. But the report on that aspect of the trip is a whole story in itself which will be given later. For the present, we must get back to the conference at Bucharest.

After a literally exhausting thirty-two hour train ride from Berlin, we arrived in Bucharest in the late afternoon of May 18th, where we were met at the station by a delegation of a dozen of the YR gang and were escorted to our hotel. There we proceeded to set up office in our room by unpacking the reams of documents which had been accumulated in the months of preparation for the conference, arranging them in order for quick reference, and setting up a desk, complete with typewriter and other office equipment which we had brought with us. That same evening we got in touch with the members of the American delegation who had arrived before us—and the three-weeks grind began.

Following the precedent of previous conferences, the U. S. delegation chief, Dr. Dellinger, kindly invited the American member of your representation (J.J.L.) to participate in the daily meetings of the American group as a representative of an American organization, A.R.R.L. This was done throughout the conference, with resulting harmonious action, particularly on the questions which had amateur interest. Several of the Roumanian amateurs connected with the Roumanian government administration and the Roumanian delegation to the conference (espe-

cially YR5AA and YR5EV) were especially helpful in advising us on the preliminary arrangements. This helpful cooperation continued throughout the conference.

With the opening formality of the first plenary meeting completed on the opening day, May 21st, and with the definite organization of the work and the agenda adopted, the routine work started. Because we have been asked by a number of amateurs, "Just how does a C.C.I.R. conference work?," a brief outline of the *modus operandi* will be given. The grist for the mill of the conference is a set of propositions or questions on a variety of technical subjects. Among the subjects proposed for this meeting of the C.C.I.R., for instance, were Question 1, selectivity curves; Question 7, wave propagation curves; Question 11, the feasibility of single-sideband transmission in broadcasting; Question 16, mitigation of electrical interference in receiving equipment. These questions, for

the most part, are proposed at the close of the preceding meeting of the C.C.I.R., at which time a participating government administration undertakes to centralize the study and prepare a report for the following C.C.I.R. As many of the other government administrations, as well as operating companies and international organizations, as may wish to do so signify their intention to collaborate in the study. This collaboration takes the form of submission of reports giving pertinent information coming within the scope of the question, which reports are forwarded by the collaborators to the centralizing administration for its use in preparing the material for presentation to the next C.C.I.R. meeting. The centralizing administration's report, including the material submitted by the collaborators, is circulated to all the other governments and to other participants who are interested in the question, well in advance of the meeting at which the question is to come up for discussion. Thus all are given the opportunity of coming prepared to handle each subject intelligently. In the discussion of each question in the conference committee to which it has been assigned, different points of view are reconciled so that a more or less complete answer in the form of a draft opinion is submitted for ratification at the final plenary meeting of the whole conference.

Only the delegations of government administrations have voting power in the C.C.I.R., of



THE I.A.R.U. REPRESENTATIVES AT THE FOURTH C.C.I.R.

John Stadler (left) and Jim Lamb

course, although it is seldom that a vote is actually taken on any proposition. Practically all of the decisions are made unanimously, the question being put by the chairman and considered as unanimously adopted if no delegation voices an objection. If there is only one objection, the proposal is considered as adopted "by a majority" without taking a roll-call vote. In the Bucharest meeting every final opinion but one was adopted unanimously in this fashion and this single opinion was adopted "by a majority" because one administration had voiced dissent.

The day-to-day work of the conference is divided among five main committees, among whom the questions are distributed in groups according to their general nature. The Bucharest Conference had 20 questions to consider, on three of which the I.A.R.U. had signified as a collaborating organization at the close of the previous C.C.I.R. meeting at Lisbon, Portugal, in 1934, at which meeting one of the present

representatives (J.J.L.) was present with K. B. Warner for the I.A.R.U. These were Question 1, receiver selectivity curves; Question 11, single-sideband transmission; and Question 16, mitigation of electrical interference in receiving equipment. We had decided to collaborate in studies on these three questions at the time of the Lisbon meeting because we believed that useful information of amateur origin could be supplied. Later, it was also decided to make a contribution on Question 7, wave propagation curves, when it became apparent that this question was to involve ultra-high-frequencies in addition to low, medium and high frequencies, since this question had bearing on our ultra-high frequencies and a fund of data based on amateur work had become available within the year.

Our studies on the other three questions had been submitted to the respective centralizing administrations nearly a year in advance of the conference, and were included in the centralizing administration's report circulated last spring. These questions were disposed of in more or less routine fashion and resulted in opinions which were satisfactory to us. From them there also resulted several new questions, in the formulation of which we participated and which represent a considerably more progressive point of view than has heretofore been evinced in C.C.I.R. meetings.

This progressiveness was an outstanding fea-

ture of the Bucharest C.C.I.R. and is evident both in the opinions adopted on the old questions and in the new questions set up for study. In previous meetings there has always been a tendency to arrive at opinions more representative of the least common denominator in technical progress, with an attitude that technical practices should be based on equipment of the poorest

performance and lowest cost rather than on the best available equipment. In this there has also been evidence of a belief that nothing is obsolete until it is so worn out that it just will not work at all, rather than the progressive attitude that anything is obsolete when there is something new which is capable of doing a superior job. Of course, this progressive attitude is more nearly representative of what we amateurs believe and is the thing which has contributed largely to our technical progress; so anything that tends to bring other users of the radio-frequency spectrum toward that point of

view must be regarded favorably by us.

In the Bucharest Conference the American delegation led in this progressive attitude, maintaining their position as established in previous conferences, and your representatives supported the movement in every way they possibly could.

In Opinion 83 on receiver selectivity, for instance, this new attitude is reflected in the statement that "in order to obtain the best possible use of the channel capacity of the different frequency bands, it is necessary to increase the selectivity of the receivers up to a maximum consistent with the needs of the service to be carried out." Again, we find evidence of the same thing in new Question 11, "Study of the minimum practical separation between stations working in adjacent channels in the fixed and mobile services." One of the reasons given for proposing this question (especially with reference to the frequencies between 4000 and 30,000 kc.) is, "that the maximum possibilities for the use of this band are perhaps not yet fully reached and that recommendations have already been made concerning (a) transmitter frequency tolerance and instability, (b) bandwidth occupied by an emission according to the type, and (c) receiver selectivity and stability, all of which factors are to be considered in determining the minimum separation between stations." Such frank admission that commercial channels are not being used to the best advantage is especially heartening, partic-



M. GELES, PRESIDENT OF THE CONFERENCE AND GENIAL OFFICIAL HOST FOR THE ROUMANIAN ADMINISTRATION, IN AN INFORMAL POSE

ularly when the admission appears in an official document coming from the very people concerned.

Further along the same line is new Question 6, "What are the selectivity requirements to be imposed for receivers in order to decrease the separation between adjacent emissions in the different services, for the entire frequency range and particularly for frequencies above 3 Mc.?" And finally in new Question 20, "Frequency band-width occupied by emissions," appear these significant words: "What requirements should be imposed upon the transmitters of the different services, with respect to the elimination of non-essential frequencies with a view to reducing the total frequency band-width effectively occupied by the emissions?" All of which suits our views exactly, because any movement toward better engineering use of commercial frequencies correspondingly relieves pressure on the amateur band assignments.

As the studies on Question 7, wave propagation curves, became available, it was seen that increasing emphasis was being placed on the propagation characteristics of ultra-high frequencies. This was especially true in the report of the centralizing administration, Great Britain. Now it might seem that this question would have little bearing on the frequency allocation problems of amateur radio. However, frequency allocations are based on a number of factors, and one of the most important of these is the propagation characteristics of waves in the different bands. Therefore, with a possible world-wide frequency allocation plan for the ultra-high frequencies looming on the horizon at the coming Cairo Conference, this question became a matter of real concern for us amateurs. An opinion on this question which was based on inadequate technical data might easily result in the formulation and adoption of a plan of allocation which would not only be technically improper but which also might seriously jeopardize our amateur ultra-high-frequency assignments. Such an allocation plan, however wrong it might be, would definitely "freeze" the ultra-high-frequency situation for at least five years before any change could be made. It therefore was up to us to make sure that the practical experimental data based on amateur work² was recognized and that an opinion based entirely on current theoretical assumptions would not be handed on from Bucharest to Cairo. In this effort we were successful.

Working at top speed, a 2000-word study summarizing known amateur experimental data on the bending of ultra-high-frequency waves in the lower atmosphere was prepared in English by J. J. L. and translated into French by J. C. S.

² Ross, A. Hull, "Air-Mass Conditions and the Bending of U.H.F. Waves," *QST*, June, 1935; and "Air-Wave Bending of Ultra-High Frequency Waves," *QST*, May, 1937.

Then both the English and French versions were turned in for circulation as an official document of the conference under the sponsorship of the U. S. delegation. This method of introducing the study assured the most expeditious acceptance and distribution. Then we started to work in the sub-committee to which the job of preparing a draft opinion had been given. Dr. van der Pol was the chairman. Our study, Official Document 81, was received with considerable interest and was included by Dr. van der Pol in the list of recognized references on which the opinion was to be based. Our work on this sub-committee finally resulted in an opinion specifically recognizing the amateur contribution by citing it as one of the official reference documents and by specifying "the effect of refraction of the atmosphere in accordance with meteorological conditions" as a fundamental factor in the propagation of ultra-high-frequency waves over short distances. With regard to long-distance (ionosphere) propagation of these waves, we also succeeded in having the opinion include frequencies from 50 to 60 Mc. (by citing the occasional DX performance of our 5-meter signals) in addition to the upper frequency limit of 45 Mc. which had been specified in the first draft.

We also collaborated in the preparation of Opinion 85 on the classification of radio waves. This proposed new classification, while it does not in any way have bearing on our use of radio frequencies, is of interest to amateurs in that it offers a somewhat more logical nomenclature for generally describing different parts of the radio-frequency spectrum. In the old classification, adopted at The Hague in 1929, the different portions of the spectrum were very indefinitely classified as "low frequency, medium frequency,

NEW C.C.I.R. CLASSIFICATION OF RADIO WAVES

Designation of Radio Waves According to Wavelength	Wavelength in Meters	Designation of Radio Waves According to Frequency	Frequency in Kilo-Cycles per Second
Myriametric	Above 10,000	Very low	Below 30
Kilometric	10,000 to 1000	Low	30 to 300
Hectometric	1000 to 100	Intermediate	300 to 3000
Dekametric	100 to 10	High	3000 to 30,000
Metric	10 to 1	Very high	30,000 to 300,000
Decimetric	1 to 0.1	Ultra-high	300,000 to 3,000,000
Centimetric	0.1 to 0.01	Super	3,000,000 to 30,000,000

In practical usage, it is permissible to express the values of both centimetric and decimetric waves in centimeters, and to express the values of the frequency of waves higher than 3000 kc. (lower than 100 m.) in megacycles per second.

medium-high frequency, high frequency, and very high frequency." The new classification proposed is more definite, having seven designations and specific upper and lower frequency limits for each range. As originally proposed by the

(Continued on page 108)

Pick Your Spot on the Neighbors' Supers

How to Avoid Interference to Local Broadcasting by Choice of Transmitter Frequency

By George Grammer*

At its 1937 meeting, the Board of Directors of A.R.R.L. ordered the publication in QST of an article explaining how beat interference from amateur signals arises in broadcast-band superhet receivers, and describing how beats with popular local stations can be avoided. Here is the information. —EDITOR.

TOO many present-day superhet broadcast receivers are wide open to what has been termed harmonic interference; i.e., beats at i.f. frequency between oscillator harmonics and a local transmitter. It has been emphasized in *QST* and in several *Handbook* editions that amateur interference to broadcasting arising from this cause is entirely chargeable to the receiver and not to the transmitter. Nevertheless, so long as broadcast receivers are built to sell at a price it is only wishful thinking to hope that a real—and consequently relatively expensive—job of shielding will be done for the purpose of eliminating occasional amateur interference. It has been suggested that the individual amateur can render unavoidable interference of this type less obnoxious to the neighbors by choosing an operating frequency which does not put a beat on top of the local broadcasting stations to which the great majority of listeners tune their b.c. receivers.

When the broadcast receiver is not right under the transmitting antenna, the harmonic type of interference is seldom objectionable except from 1.75- and 3.5-Mc. transmitters. We shall therefore confine the discussion principally to these two bands, although it should be realized that in some cases even higher frequencies may produce strong beats in receivers in close proximity to the transmitter. Before getting down to the harmonic business, however, there are two other types of "tunable" interference which may occur; these are cross-modulation and image interference. With a little care in observation, it is not difficult to differentiate between the three types by a simple listening test.

CROSS MODULATION

Cross modulation is not often encountered with broadcast receivers made in the last five years or so except possibly in cases where the transmitting antenna and b.c. antenna are quite close. Variable- μ tubes have eliminated most of it. It may occur with old receivers of the t.r.f. variety, and can be recognized by the fact that the amateur

signal "rides in" on top of a strong local station, but is not present when the receiver is tuned off. There is no heterodyne beat between the two signals, as is always the case with image or harmonic-type interference when these happen to "land on" a broadcast station.

Aside from operating on the receiver, about the only thing that can be done to mitigate this type of interference is to keep the transmitter signal out of the receiver's input circuit. A wave-trap tuned to the operating frequency or a low-pass filter,¹ inserted in the antenna lead to the receiver, usually will cure it.

IMAGE INTERFERENCE

Most of us are familiar with images, if only from getting them on amateur superhets with insufficient pre-selection. Image interference to broadcasting occurs only from transmitters in the 1715-kc. band, which is separated from the broadcast band by but a few hundred kilocycles. Just where the image is to be found will depend upon the intermediate frequency used in the affected receiver.

Older receivers with i.f.'s in the vicinity of 175 kc. will be subject to image interference from amateur signals only in the region 1715-1850 kc., but the higher i.f.'s now common (of the order of 465 kc.) can pick up image interference from over the whole band. Fortunately the image rejection ratio is also higher with the high i.f. frequencies, so that the interference is likely to be less severe than on a receiver having a 175-kc. i.f. Tables I and II include data on image responses for the two i.f.'s, and show the frequency on the b.c. receiver dial at which an image from the transmitter frequency indicated will be heard. Images from frequencies between the spots chosen will of course be found at intermediate positions on the b.c. dial.

The dial setting at which an image response will appear can be found from the formula

$$b = x - 2a$$

* Assistant Technical Editor.

¹ *The Radio Amateur's Handbook*, Chapter 10.

where b is the dial setting or apparent b.c. frequency at which the interfering signal is received, x is the transmitter frequency, and a is the i.f. of the receiver. For example, if the transmitter frequency, x , is 1910 kc., and the receiver i.f., a , is 456 kc., then

$$b = 1910 - (2 \times 456) = 998 \text{ kc.}$$

A 2-kc. beat would be produced with a broadcast station on 1000 kc.

Images and harmonic beats are similar in effect; both can be tuned in and out in the same way as a regular broadcast station. However, an image signal will tune at the same rate as a broadcast signal of the same strength; that is, the apparent selectivity of the receiver is the same in either case. With a harmonic beat the tuning is faster in the ratio of the harmonic. Suppose, for instance, that a regular signal occupies 2 divisions on the dial. An image will occupy the same, but a beat with the second oscillator harmonic will occupy only 1 division, and a beat with the fourth harmonic only $\frac{1}{2}$ division, and so on. The difference in tuning rate often makes it possible to identify an image directly. In cases where it is difficult to check by this method, substituting the known factors in the above formula will show whether or not an interfering signal is an image. If the answer doesn't come out right, it's a harmonic beat.

It may or may not be possible to reduce image interference with a particular receiver. If the amateur signal is getting into the b.c. receiver through the antenna, a wave trap or filter can be used to advantage. However, with strong local signals it is just as likely that the signal is getting in in other ways, in which case traps will do no good. One consolation is that it is not the transmitter's fault.

BEATS WITH OSCILLATOR HARMONICS

The only difference between a harmonic beat and an image is that the former is produced when the transmitter is on a frequency equal to a harmonic of the receiver's oscillator plus or minus the i.f. of the receiver, while the latter occurs only

when the signal frequency is the fundamental of the oscillator plus the i.f. On the harmonic, therefore, there are two frequencies which can produce a spurious signal. When we consider the fact that an oscillator has a whole series of harmonics, it becomes apparent that a not-too-well shielded b.c. receiver is pretty vulnerable to signals having frequencies which don't appear on its dial. Add to this the fact that oscillator harmonics also can beat with transmitter harmonics and it's no wonder that the set downstairs suddenly becomes full of birdies when you switch on the carrier.

By way of illustration, Tables I and II show the possible spurious signals on the receiver for i.f.'s of 460 kc. and 175 kc. It will be noted in Table I that transmitters in the 1715-kc. band will cause only straight images and one set of beats with the oscillator second harmonic. Images will be found between 795 and 1080 kc., and harmonic beats between 627.5 and 770 kc., depending upon the transmitter frequency. Transmitters in the 3.5-Mc. band will not cause images, but beats are possible with the second, third and fourth oscillator harmonics. The transmitting frequencies chosen for illustrative purposes mark the edges of the bands and the 'phone sub-bands. Intermediate frequencies will of course give responses at corresponding in-between spots on the b.c. receiver dial.

The receiver with a 175-kc. i.f. is likely to be a troublemaker, as Table II shows. In the 1715-kc. band there is one set of second-harmonic beats, while part of the band will give images. On 3500 kc. there is a small region of second-harmonic beat response, and a whole series of higher-harmonic responses. A transmitter on exactly 3500 kc., for instance, would be heard on the b.c. receiver at 1487.5, 1050, 933.3, 743.75, 656.25, and 560 kc. Quite an assortment!

The transmitter frequency at which a harmonic

(Continued on page 78)

TABLE I

I.F. Frequency—460 kc.					
Operating Frequency	Apparent Response Frequencies on B.C. Receiver				
	Image	2nd Harmonic	3rd Harmonic	4th Harmonic	
1715	795	627.5			
1800	880	670			
2000	1080	770			
3500		1060	860	553.3	*
3900		1260	993.3	686.6	630
4000		1310	1026.6	720	655

* Response starts at 3580 (550 kc.); none between 3500 and 3580.

TABLE II

I.F. Frequency—175 kc.									
Operating Frequency	Apparent Response Frequencies on B.C. Receiver								
	Image	2nd Harmonic	3rd Harmonic	4th Harmonic	5th Harmonic				
1715	1365	770	595						
1800	1450	812.5	637.5						
2000	*	912.5	737.5	**					
3500		1487.5	1050	933.3	743.75	656.25	560		
3900		***	1183.3	1066.6	843.75	756.25	640	570	
4000			1216.6	1100	868.75	781.25	660	590	

* No image response above 1850 kc.

** Only response is at 550 kc. from a 2000-kc. signal.

*** Response on 2nd harmonic only from 3500-3525 signal (1487.5-1500 kc.)

A 50-Watt C.W.-'Phone Transmitter for 220-Volt D.C.

A Practical Rig for the Ham Living in D.C. Districts

By M. P. Mims,* W5BDB

THE trials and tribulations of the ham living in d.c. districts were something we had always left up to the Secretary of State or somebody else—whoever he might be. In other words, we simply felt that he who lived in a d.c. district should either move or forget ham radio and go back to playing marbles. This, of course, excepts the fellow who has the “where-with-all” to go ahead and install large generators, alternators, or other equipment to the great annoyance of his neighbors for several blocks around.

Our peace of mind on this subject was shattered one morning when a friend down in Antigua came through with a letter saying he had a license—VP2DA—and nothing with which to transmit. Moreover, the only power on the island is the 220-volt d.c. system in St. Johns, where he lives. For some reason or another it seemed to us that ham radio could provide a fellow in a place like this, where news is a bit tarnished on delivery, with a good deal more pleasure and benefit than many of us here in the States. Then, too, the thing looked interesting.

First of all, insofar as we were able to learn, the maximum input to any known d.c. transmitter operating directly from 220-volt d.c. supply mains was about 20 watts, this particular job being a push-pull oscillator arrangement at that. The original request we received was for an *output* of 20 watts on 'phone for 20 and 40 meters.

Quite naturally, the big problem in the design of such a transmitter is the selection of tubes to be

used. The circuit must then be made to conform to the characteristics of the tubes selected. Our first thought was of the RK-100's. However, the manufacturers advised us against using these tubes at a plate potential of 220 volts. The Type 10's with thoriated filaments also looked quite interesting from the standpoint of low plate voltage and high current, but the proposition of dropping a 220-volt line down to supply filaments for these tubes made this impractical, as the voltage drop would have to be quite large and the current high, making extremely large resistors necessary. This would run the cost up and at the same time produce a great deal of heat.

The final selection fell to the Type 48 receiving tube. The 30-volt filament and its low current characteristics were extremely useful. The tube could be used either in pentode or triode connections, and in triode connection proved to have, at this plate voltage, Class-B cut-off bias characteristics.

Having decided this tube type looked more favorable than any other available, a breadboard unit was built up. It was through this experimentation we learned of the self-biasing feature of the tube triode-connected. Characteristics were not available on the tube for this connection—that is, with the screen and plate tied together. Our first intentions were to use a 48 as a Tri-tet oscillator with a 7-Mc. crystal doubling for 14 Mc., and as a straight pentode for 7 Mc., then to follow this with another 48 as a buffer, using the triode connection. The oscillator pentode-connected

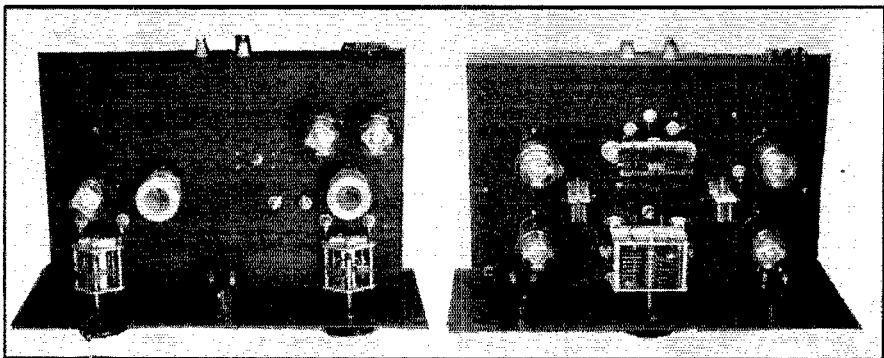

THE R.F. CHASSIS: EXCITER AT LEFT, PUSH-PULL-PARALLEL FINAL AT RIGHT
All the r.f. tubes are 48's, and all, with the exception of the oscillator, are triode-connected.

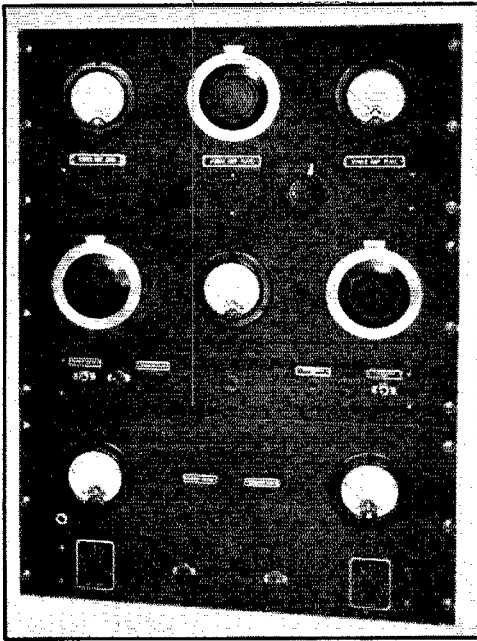

THE PANEL DOESN'T INDICATE IT, BUT THIS RIG IS A 50-WATT PHONE-C.W. TRANSMITTER WORKING DIRECTLY FROM 220-VOLT D.C. MAINS

delivered a nice drive over to the buffer but, when used as Tri-tet doubling, it would not drive a single 48 sufficiently as a buffer on 20. Much more output was obtained running the oscillator as a pentode and doubling in the second stage. Considerable work and effort was spent along this line in varying the circuit constants throughout, particularly LC ratios, coupling arrangements and whatnot. It was found that relatively low inductance was needed in this set-up for best efficiency (this due to low E_p and high I_p). The output of the doubler, even though this was better, was not yet sufficient.

Another 48 was worked into the circuit, making the buffer-doubler a parallel stage. The output went up considerably on 40 meters and there was more than ample excitation to drive the final. The same proved true on 20 meters, so the exciter unit finally

decided on consisted of a 48 pentode oscillator driving parallel 48's as buffer doublers. These three tubes in their own filaments had a 90-volt drop. It was decided that the final should consist of push-pull-parallel 48's, making a total of seven tubes in the r.f. line up and giving a total filament drop of 210 volts. Manufacturer's ratings on these tubes allow for 5 per cent filament voltage variation so that the line voltage could vary from 200 to 220 and still allow the tubes to work efficiently.

With the breadboard exciter remaining intact, the push-pull-parallel final was built up employing split-stator grid circuit and a single-section condenser to tune the plate, criss-cross neutralization being used. The circuit diagrams should be quite clear and all values given are the ones finally used. The exciter was link-coupled to the final and we found we were able to load the Class-C stage to 225 ma. at a line voltage of 220 volts, making the input $49\frac{1}{2}$ watts. The exciter was then assembled in its permanent form in the rack-mounting unit and the r.f. section was complete.

The construction of the final amplifier stage was conventional. The photographs make this clear except for the grid circuit. The grid coils are wound on the usual $1\frac{1}{2}$ -inch 5-prong forms and plug into a socket on the underneath side of this chassis. This socket is mounted vertically for the coil to plug in horizontally and is located in the front center of the unit. Two 50- μ fd. condensers were used as a split-stator unit to tune the grid. The use of two condensers allowed us to maintain a symmetrical circuit, which we were especially

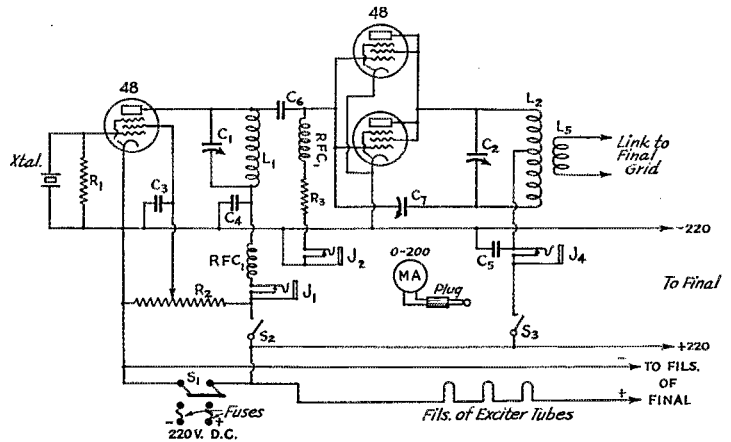

FIG. 1—WIRING DIAGRAM OF THE 220-VOLT EXCITER

- | | | |
|---|---|---|
| C_1, C_2 —100- μ fd. variable (National TMS-100). | R_2 —1000-ohm 1-watt. | L_2 —7 Mc.: 15 turns No. 18; length 1 inch, diameter $1\frac{1}{2}$ inches. |
| C_3, C_4, C_5 —0.01- μ fd. mica (Aerovox). | RFC—Sectional s.w. choke (National R-100). | 14 Mc.: 10 turns No. 18; length 1 inch, diameter $1\frac{1}{2}$ inches. |
| C_6 —50- μ fd. mica (Aerovox). | S_1 —D. p. s. t. switch. | |
| C_7 —25- μ fd. midget (National UMA-25A). | S_2, S_3 —S. p. s. t. switch | |
| R_1 —5000-ohm, 1-watt. | J_1, J_2, J_4 —Closed-circuit jack. | |
| R_2 —2500-ohm, 50-watt semi-variable. | L_1 —15 turns No. 18; length 1 inch, diameter $1\frac{1}{2}$ inches (7-Mc. xtal). | L_5 —Link winding, two or three turns, adjusted to give proper excitation. |

anxious to have in order to keep down any tendency for parasitics in the push-pull-parallel circuit. Parasitics were encountered but were easily eliminated by using the RFC_2 parasitic chokes. These were made of six turns of No. 14 spaced over approximately $1\frac{1}{2}$ -inch length and wound on a $\frac{1}{2}$ -inch diameter. The spacing between turns of these chokes was adjusted until all parasitics were eliminated. The final tank coils were of the air-spaced type supported by small strips of cellulose acetate.

After sufficient juggling of circuit constants, we found we were able to get very

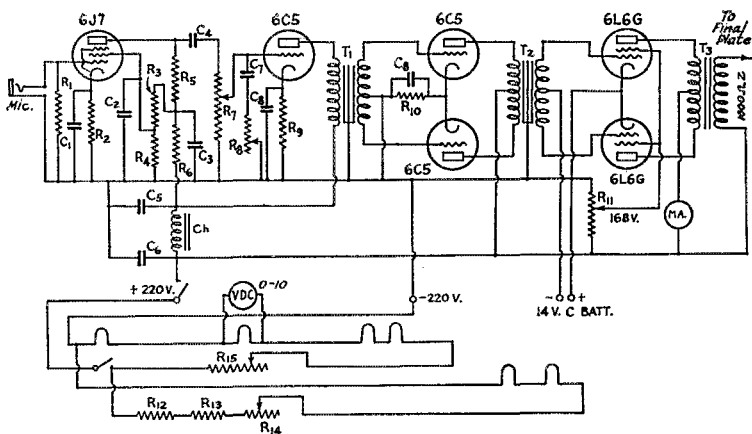

FIG. 3—THE 220-VOLT SPEECH-AMPLIFIER AND MODULATOR

- | | | |
|---|---|---|
| R1—5-megohms, $\frac{1}{2}$ -watt. | R10—500-ohm, 1-watt. | C3—8- μ fd., 450-volt electrolytic. |
| R2—3000-ohm, 1-watt. | R11—3000-ohm, 25-watt semi-variable. | C4—0.1- μ fd., 600-volt paper. |
| R3—250,000-ohm, 1-watt. | R12, R13—100-ohm, 100-watt (Ohmite 0604). | C5, C6—8- μ fd., 450-volt electrolytic. |
| R4—50,000-ohm, 1-watt. | R14—50-ohm semi-variable (Ohmite 0959). | C7—0.01- μ fd., 400-volt paper. |
| R5—250,000-ohm, 1-watt. | R15—1000-ohm, 200-watt semi-variable (Ohmite 1162). | C8—10- μ fd., 25-volt electrolytic. |
| R6—10,000-ohm, 1-watt. | Ch—30-henry choke. | T1—Push-pull input transformer (Thordarson T-5741). |
| R7—500,000-ohm volume control. | C1—10- μ fd., 25-volt electrolytic. | T2—Class-AB input transformer, special. |
| R8—250,000-ohm variable (tone control). | C2—2- μ fd., 450-volt electrolytic. | T3—Class-AB output transformer, special. |
| R9—3000-ohm, 1-watt. | | |

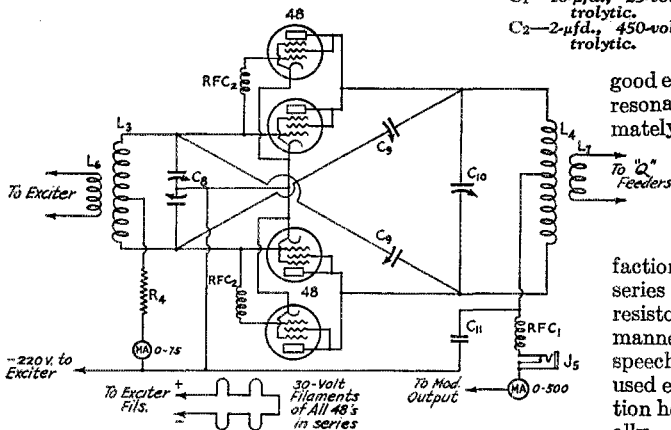

FIG. 2—THE PUSH-PULL-PARALLEL AMPLIFIER CIRCUIT

- C8—Split-stator, 50 μ fd. per section (two National UM-50 ganged).
 C9—25- μ fd. midget (National UMA-25).
 C10—100- μ fd. variable (National TMC-100).
 C11—0.002- μ fd. mica (Aerovox).
 R4—400-ohm, 10-watt.
 RFC1—Sectional-wound choke (National R-100).
 RFC2—Parasitic chokes; see text.
 RFC3—Parasitic chokes; see text.
 L3—7 Mc., 30 turns No. 18; length $1\frac{1}{2}$ inches, diameter $1\frac{1}{2}$ inches.
 L4—7 Mc., 16 turns No. 18; length $1\frac{1}{2}$ inches, diameter $1\frac{1}{2}$ inches.
 L5—7 Mc., 6 turns No. 14; diameter 2 inches, length $2\frac{1}{2}$ inches.
 L6—7 Mc., 10 turns No. 14; diameter 2 inches, length $2\frac{1}{2}$ inches.
 L7—Wound over L4; adjusted to give proper coupling to antenna.
 J5—Closed-circuit jack.

good efficiency in the final, the unloaded resonance dip of the final being approximately 30 ma. at 220 volts, or between 6 and 7 watts input.

AUDIO SYSTEM

After it had been found that the 48 tubes would give satisfaction with the seven filaments in series and that the filament dropping resistors could be eliminated in this manner, we wished to use them in the speech equipment also. They could be used either in pentode or triode connection here and would make things generally desirable. Several transformer manufacturers were contacted for a suitable output transformer to work from these tubes operating either Class-AB or Class-B to deliver 25 watts of audio at 220 volts E_p . Here we were in trouble sure enough, for no tube manufacturer had published characteristics on the tubes for this particular use.

At about this stage of the experimentation the 6L6 tube was announced. Filament characteristics were found suitable and the tube was ideal from the standpoint of being able to pass high current at low plate voltage. Again transformer manufacturers were contacted and a suitable unit was produced specifically for this purpose, as well as a special input transformer. A 6J7 was used as a

(Continued on page 82)

will be strained in the direction of the applied force. Application of an e.m.f. to the faces of a low-coefficient crystal, however, will not produce a strain through the crystal, but, because of its peculiar orientation, will cause a shifting of the upper and lower faces. When an alternating e.m.f. is applied to the faces of this type of crystal it is said to be executing a shear mode of vibration. Because the modulus of elasticity varies with the degree of orientation, crystals cut on various angles exhibit varying degrees of activity. The low-coefficient cut is much more active than the X-cut.

The first crystal of this type which was used

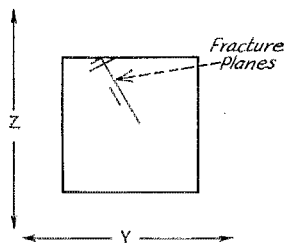

FIG. 2—FRACTURE PLANES IN AN X-CUT CRYSTAL
The fracture is parallel to the X-axis.

had a frequency of 3500 kc. It was 0.0286 inch thick and had a thickness constant of 100.² The crystal was mounted in a holder whose plates rested directly on the crystal. Repeated tests showed the inadvisability of using this type of mounting for fracture studies. When so mounted and fractured by the method already outlined the breakage is usually in the nature of a pin-point flaw through the crystal. The air-gap type of holder was next tried and better results were immediately obtained. On the first test with this mounting a beautiful fracture .43 inch long was obtained. The distinguishing characteristic of this type of fracture was that the fracture plane appeared to be parallel to the Z-axis. Careful measurement substantiated this. The fracture plane, in other words, passes through the surfaces at an angle which is equal to the original B angle on which the crystal was cut. Several other tests with crystals having various B angle orientations proved the point. The diagram shown in Fig. 3 may make this type of fracture more clear.

Tests with 3500-ke. crystals having a thickness constant of 67 gave similar results; in this case the fracture plane was "on the other side" of the Z-axis; since the crystal had been so orientated this was to be expected.

Subsequent tests with these low-coefficient crystals yielded one remarkable specimen. On removing this particular crystal from its holder after fracturing, a series of parallel lines quite regularly spaced was noted on the surfaces of the holder plates. These lines were parallel to the b dimension of the crystal. Measurement of the distance be-

² $F \times t = K$, where F is in megacycles, t in thousandths of an inch.

tween these lines showed it to be equal to the thickness of the crystal. This would seem to indicate a series of waves across the surface of the crystal in the direction of the a dimension; furthermore, this is probably the reason for edge grinding to strengthen a plate. That the thickness frequency should be a harmonic of the width oscillation seems to be quite absurd in this case because of the high harmonic ratio. This would also account for the critical effects of edge-grinding in very high-frequency crystals. Microscopic examination of some of the earlier specimens showed the presence of these lines in the fracture planes of the crystals. In some of the crystals they were clearly discerned with the eye alone.

One test was made with a low-coefficient crystal having a frequency of approximately 300 kc. In this case the oscillator was fitted for regeneration because of the low frequency involved. Tests are now being conducted to determine the plane of fracture in both length and width oscillators.

THE OSCILLATOR CIRCUIT

Three major methods of safeguarding the crystal appear to be in use at the present time. They are:

1. Low oscillator plate voltage.
2. Use of a tube of the high-mu or pentode type.
3. A fuse device in the crystal circuit.

The use of the first-mentioned method is prob-

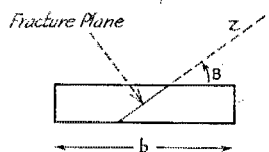

FIG. 3—FRACTURE PLANE IN A LOW TEMPERATURE COEFFICIENT CRYSTAL
Fracture parallel to the Z-axis.

ably the most reliable once the correct value of plate voltage consistent with power output and the safety of the crystal is determined. In a circuit followed by several stages of frequency multiplication it might be a decided disadvantage, probably making an extra amplifier stage necessary. The second method is probably the best from a practical standpoint. It has the advantage of medium power output with little crystal current. Precautions must be taken, however, to insure that the feedback voltage does not become too large. Tubes such as the Type 802 which require an external feedback capacity are likely to be erratic performers in this respect, especially at the higher frequencies. The third method is the least desirable from the operating standpoint. No one likes to be replacing fuses and lamp bulbs to say nothing of suddenly going off the air. Any type of protection for the crystal should be of a compensating or dynamic type which will automatically reduce transients through the crystal. One such method along these lines is the

(Continued on page 84)

Beam Tubes in a Push-Pull Amplifier

A 14- and 28-Mc. Rig Utilizing the RK-48's for C.W. and 'Phone Work

By Clark C. Rodimon,* WISZ

WHAT ham doesn't lick his chops in anticipation of a final amplifier of high-power proportions that takes its excitation directly from a crystal oscillator or two-tube universal exciter? Announcement of the beam-power transmitting tubes in *QST* started a scramble in our laboratory for a chance to check their performance against their counterparts in the pentode field. The tubes we are referring to, in case you haven't guessed by now, are the RK-48 and RK-47, which look and have approximately the same ratings as the RK-28 and RK-20, respectively. The RK-47 was written up in August *QST* so we shall content ourselves solely with the RK-48.

As the manufacturers specified extra-special small amounts of driving power for these tubes, we decided to set up an amplifier with as little manual labor as possible and give the RK-48's a whirl.

Before the amplifier could be given a run it was necessary to produce a few watts of excitation. Nothing suitable appeared at hand that would deliver few enough watts so a small exciter was constructed and will be described briefly. It consists of a single 6L6 crystal-controlled with pentode connections as shown in Fig. 1. A 14-Mc. crystal was used to drive the 6L6. A four-prong cable carried the filament plate and screen supply to the exciter unit. Screen voltages obtained from the dropping resistor from the 400-volt plate supply. With the resistor values shown, the plate current was 70 ma. when the grid current to the following amplifier was 25 ma. The 400-volt supply for the exciter was also used for

the screen supply to the RK-48's. (These screens take 75 ma. per tube so one who attempts to do the same should take this under consideration.) The 25-ma. grid current under full load was more than ample to drive the amplifier to full output. In fact, anything above 18 ma. seemed to add practically nothing to the output. The plate coil

for the exciter was wound on a four-prong 1-inch form. The plate winding required 9 turns which occupied 1 inch. The link was 2 turns of the same dimensions loosely coupled to the "cold" end of the plate coil. The link connections were brought out through the side of the chassis to a two-terminal mounting strip, matching an input terminal on the side of the amplifier. With an active crystal no difficulty should be encountered getting this to "mote," contrary to the opinion of those who hesitate to use 14-Mc. crystals.

The exciter chassis measured 5 inches square and 3 inches

high and was cut from a single piece of sheet aluminum.

The amplifier to be described was constructed for use only on 28 and 14 Mc. It was reasoned that the efficiency of an amplifier dropped very rapidly above 7 Mc. and to preserve as high an order as possible, it would be necessary to approach closely an optimum in L/C ratios. This would be impossible with a given single tuning condenser and plug-in coils to cover several amateur bands. An ideal arrangement would be to design an amplifier for the highest frequency to be used and make the L/C ratios optimum for that band. When going to lower frequencies one should add both to L and C as is done in receivers.

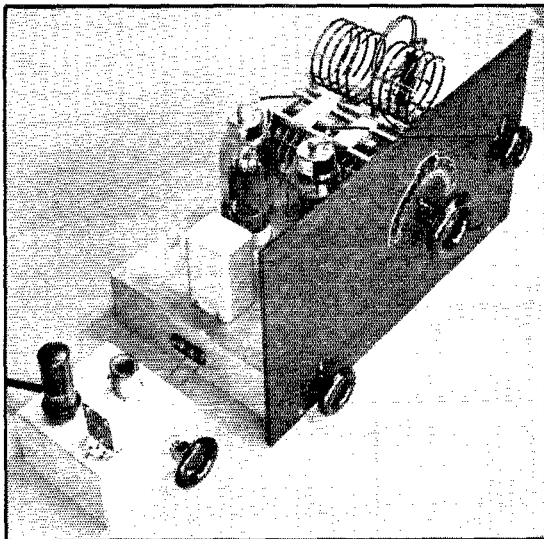

SET UP COMPLETE FOR 14-MC. OPERATION AND 450 WATTS OUTPUT

At the left may be seen the 6L6 exciter with link connections going to the amplifier. At the right of the amplifier may be seen the method of controlling the link coupling at the center of the B & W coils. The left control on the amplifier is grid tuning. The center wheel controls the plate tuning with the right-hand wheel controlling the link adjustment.

* Managing Editor.

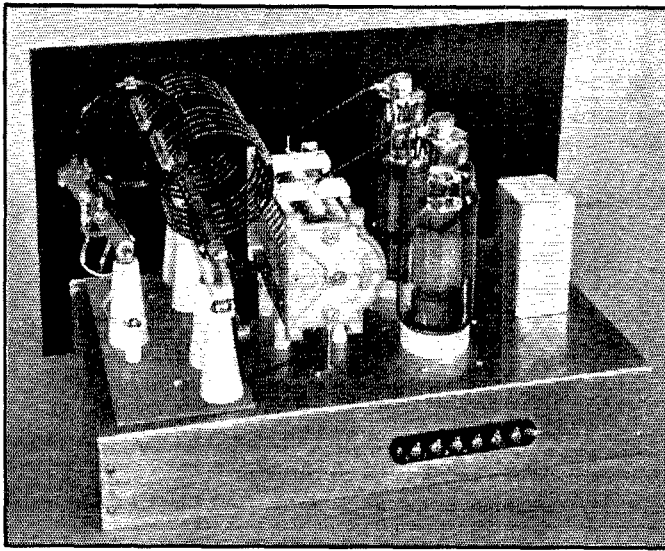

REAR VIEW OF THE RK-48 P.P. AMPLIFIER

Enough space is available at the grid end of the chassis to incorporate a one- or two-stage exciter.
Note the simplicity of wiring.

Adding to *L* is not too much of a problem. However, to get a "plug-in" condenser for transmitters (that fits on the plug-in coil) without great dielectric loss at high frequencies or one whose size does not become objectionable, seems to be a problem at the moment. In this case it was decided to use a condenser not too far away from the optimum for the two bands and still have enough of a tuning range so that it would not be necessary to change coils to cover an entire band. A Hammarlund TCD-50-A was picked to do the job in the plate circuit as it had the capacity desired with enough spacing for plate modulation and still was not too bulky for the chassis.

CONSTRUCTION

An aluminum chassis measuring 17 inches by 11 inches by 3 inches was picked to carry all the gear without any undue crowding. The 3-inch depth allowed the RK-48's to be dropped below the level of the base for shielding purposes. The tubes fit into a Communications Engineering Co. double socket that is mounted below the base on 1-inch standoff insulators. It would have been advisable to use 1½-inch insulators but none were available and this transmitter had to be built one afternoon, tested that evening, photographed the following morning and carted off to Erie in the afternoon to the Atlantic Division Convention. By mounting the grid condenser below the base and shielding the grid coil, a fairly effective job has been done of separating the grid and plate circuits to keep down the reaction as much as possible. Underneath the base all wires go directly to their objectives with the axiom "a

straight line is the shortest line between two points."

On top of the chassis the wiring is really simplified, there being only five pieces of wire used. Two go from the condenser to the plate coils and two from the condenser to the tube plates with the last wire coming through a butt-in at the base, series-feeding high voltage to the center of the coil. The plate condenser is mounted on four 1-inch insulators. This seemed optimum for direct leads and also gives the experimenter a chance to try shunt feed or series feed with the stator isolated from the chassis by a blocking condenser if desired.

The plate coil is a Barker and Williamson type 20HDVL which has a diameter of 3½ inches and a winding space of 5½ inches. As originally received, there was too much inductance for 14-Mc. operation. One turn was taken off each end of the coil (leaving 10) and the remaining inductance was just right. A variable link coupling unit controlled from the panel fits into the center of the plate coil, thus dividing the output load evenly.

The grid condenser is mounted underneath the chassis below the grid coil. Series feed is also used in the grid circuit. No r.f. by-pass condensers are necessary. The grid coils were wound self-

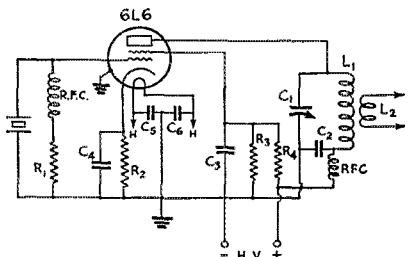

FIG. 1—6L6 EXCITER USED TO DRIVE RK-48 AMPLIFIER

- R₁—20,000-ohm, 1-watt.
- R₂—300-ohm, ½-watt.
- R₃—50,000-ohm, 2-watt.
- R₄—10,000-ohm, 10-watt.
- C₁—100-µsfd. receiving type.
- C₂—0.002-µsfd. receiving type.
- C₃, C₄, C₅, C₆—0.01-µsfd. 600-volt paper.
- L₁, L₂—See text.
- RFC—R100 chokes.

supporting on National Type PB-10 plug-in forms which come with shield cans to fit over these forms. A connection is made to ground via one of the 6 prongs on the form by means of a

soldering lug that is fitted over one corner and automatically grounded when the shield can is attached to the form with screws. The 20-meter grid coil consists of 14 turns, 1-inch diameter, of No. 14 tinned copper wire, self-supporting and occupying a winding space of $1\frac{1}{2}$ inches. Grid bias is fed at the center of the coil. A two-turn link is wrapped loosely around the outside of the grid coil proper for both the 14- and 28-Mc. coils. A 10-meter grid coil has 6 turns of the same diameter wire, occupying 1-inch winding space.

Power supply connections go to a terminal strip at the rear of the chassis. The panel is a piece of 19-inch by $12\frac{1}{4}$ -inch Lamtex or Masonite. Coto control wheels were used for controls.

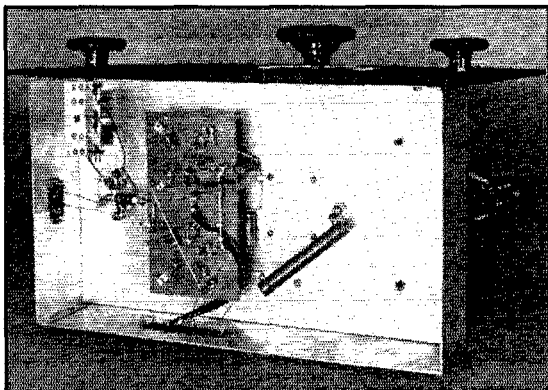

UNDERNEATH THE CHASSIS

Practically all the wiring is direct to the dual socket and terminal strip.

OPERATION

On 14 Mc. with 2000 volts on the plate and 400 on the screen and fixed bias of 100 volts, the minimum plate current for the two tubes in resonance was 40 ma. The shielding was not complete enough for absolute suppression of reaction between plate and grid circuits. Interaction was barely noticeable and so low that no difficulties were encountered at any time. Under full load of 320 ma. the output was about 450 watts. At this point the plates just gave an indication of color. Should the screen be operated at less than the maximum rating of 400 volts, the efficiency will drop and the plates will start to heat.

Following the same ratings a series of tests was run on 28 Mc. though it was necessary to resort to a 2-tube exciter that delivered 12-15 watts of 28-Mc. output as no 28-Mc. crystal was available for the 6L6 exciter. The amplifier, as was expected, did not run so efficiently as on 14 Mc. A greater amount of driving power was tried but it did not materially affect the efficiency. The output on this band was only 350 watts with the plates showing a shade more color than on 14 Mc. Connections from the plate condenser to the coil were made of No. 12 solid copper wire which heated very seriously on this band and not at all on 20 meters. It is reasonable to suspect the L/C ratio in the plate circuit for a considerable part in this efficiency drop. The 28-Mc. plate coil is a B & W Type 10HDVL which has four turns of $\frac{3}{16}$ -inch copper tubing and the same winding space as the 20-meter coil.

As pointed out last month in the article on the

RK-47's, the plate current of the beam tubes reacts much as that of triodes, with low minimum plate current rising to high values, depending on the output load. Operating at better efficiency, the output capability of the RK-48 is probably 10 per cent greater than that of its pentode brother with the same input.

Pentodes have always seemed attractive to the amateur because they are easy to drive and should one care to modulate the tube there is a choice of suppressor or plate and screen modulation. With the beam power tube there is no suppressor so that variety of modulation cannot be utilized. As compensation, the beam tubes may be plate modulated alone without the necessity of including

the screen. Tests bore out this possibility and linear modulation was secured at the 100 per cent level. No changes whatsoever were necessary in supplies or load conditions to go from A1

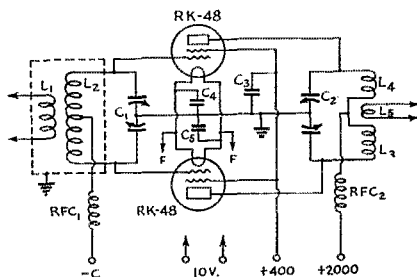

FIG. 2—BEAM POWER AMPLIFIER USING RK-48'S
 C_1 —140 μ fd. per section (Hammarlund MCD-140-S).
 C_2 —50 μ fd. per section, spacing (Hammarlund TCD-50-A).
 C_3 —0.005 μ fd., 1000-volt.
 C_4, C_5 —0.01 μ fd. 600-volt paper.
 RFC_1 —R100 choke.
 RFC_2 —1-amp. high frequency choke.
 For coil specifications see text.

to A3 emissions, save that the output load had to match the modulator output.

We have been asking for high-powered beam tubes and now we have them.



Can you qualify for The DX Century Club? See page 59.

What the League Is Doing

League Activities, Washington Notes, Board Actions—For Your Information

Election Notice To all members of the American Radio Relay League residing in the Dominion of Canada, Atlantic Division, Dakota Division, Delta Division, Midwest Division, Pacific Division, and Southeastern Division:

You are hereby notified that, in accordance with the constitution, an election is about to be held in each of the above-mentioned regions to elect both a member of the A.R.R.L. Board of Directors and an alternate thereto. In the case of the Dominion of Canada the election is to choose a Canadian General Manager and an alternate Canadian General Manager, for the 1938-1939 term. In the case of the United States divisions, the election is to choose a division director and an alternate division director for the 1938-1939 term. Your attention is invited to Sec. 1 of Article IV of the constitution, providing for the government of the A.R.R.L. by a Board of Directors; Sec. 2 of Article IV, and By-Law 12, defining their eligibility; By-Laws 13 to 23, providing for the nomination and election of division directors, and By-Law 14 providing for the simultaneous election of alternate division directors; By-Laws 27 to 34 providing for the nomination and election of a Canadian General Manager, and By-Law 28 providing for the simultaneous election of an alternate Canadian General Manager. Copy of the Constitution & By-Laws will be mailed any member upon request.

Voting will take place between November 1 and December 20, 1937, on ballots that will be mailed from the headquarters office in the first week of November. The ballots for each election will list, in one column, the names of all eligible candidates nominated for the office of director by A.R.R.L. members residing in that region; and, in another column, all those similarly named for the office of alternate. Each member will indicate his choice for each office.

Nomination is by petition. Nominating petitions are hereby solicited. Ten or more A.R.R.L. members residing in any one of the above-named regions may join in nominating any eligible member of the League residing in that region as a candidate for director therefrom, or as a candidate for alternate director therefrom. No person may simultaneously be a candidate for the offices of both director and alternate. A separate petition must be filed for the nomination of each candidate, whether for director or for alternate director. The following form for nomination is suggested:

(Place and date)

*Executive Committee
The American Radio Relay League
West Hartford, Conn.*

Gentlemen:

We, the undersigned members of the A.R.R.L. residing in the Division (or in the Dominion of Canada), hereby nominate of as a candidate for director (or for alternate director, or for Canadian General Manager, or for alternate Canadian General Manager, as the case may be) from this region for the 1938-1939 term.

(Signatures and addresses)

The signers must be League members in good standing. The nominee must have been both a member of the League and a licensed radio amateur operator for a continuous term of at least four years preceding the receipt by the Secretary of his petition of nomination. He must be without commercial radio connections: he may not be commercially engaged in the manufacture, selling or renting of radio apparatus normally capable of being used in radio communication or experimentation, nor commercially engaged in the publication of radio literature intended, in whole or in part, for consumption by licensed radio amateurs. Further details concerning eligibility are given in By-Law 12. His complete name and address should be stated. All such petitions must be filed at the headquarters office of the League in West Hartford, Conn., by noon E.S.T. of the 1st day of November, 1937. There is no limit to the number of petitions that may be filed, but no member shall append his signature to more than one petition for the office of director and one petition for the office of alternate director. To be valid, a petition must have the signatures of at least ten members in good standing; that is to say, ten or more members must join in executing a single document; a candidate is not nominated by one petition bearing six signatures and another bearing four signatures. Petitioners are urged to have an ample number of signatures, since nominators are frequently found not to be members in good standing.

Present directors and alternates for these regions are as follows: Dominion of Canada, Canadian General Manager, Mr. Alex Reid, VE2BE, St. Lambert, P. Q.; alternate, none. Atlantic Division, Director, Mr. Walter Bradley Martin, W3QV, Roslyn, Pa.; alternate, none. Dakota Division, Director, Mr. Carl L. Jabs, W9BVH, St. Paul, Minn.; alternate, Mr. Fred

W. Young, W9MZN, Mankato, Minn. Delta Division, Director, Mr. E. Ray Arledge, W5SI, Pine Bluff, Ark.; alternate, none. Midwest Division, Director, Mr. Floyd E. Norwine, jr., W9EFC, St. Louis, Mo.; alternate, Mr. O. J. Spetter, W9FLG, Topeka, Kan. Pacific Division, Director, Mr. S. G. Culver, W6AN, Berkeley, Calif.; alternate, Mr. J. L. McCargar, W6EY, Oakland, Calif.; Southeastern Division, Director, Mr. Bennett R. Adams, jr., W4APU, Homewood, Ala.; alternate, Mr. S. J. Bayne, W4AAQ, Birmingham, Ala.

These elections constitute an important part of the machinery of self-government in A.R.R.L. They provide the constitutional opportunity for members to put the direction of their association in the hands of representatives of their own choice. Members are urged to take the initiative and file nominating petitions immediately.

For the Board of Directors:

K. B. WARNER,
Secretary

July 31, 1937.

Death of Prall We are pained to have to report the passing, on July 23rd, of Mr. Anning S. Prall, chairman of the Federal Communications Commission, after a brief illness. Mr. Prall had ably presided over the Commission in its difficult administration of complex problems. Mr. Prall was a firm believer in the amateur. Just two months ago we reported his broadcast remarks at the presentation of the Paley Award, at which time he said: "I wish to assure the 47,000 amateur radio operators of this country of our sustained interest in their problems and their continued welfare. The Commission has always maintained and I think will continue to maintain a liberal attitude toward the amateurs. We recognize that the service they have performed and can perform in the future is one of our country's great assets. We will continue to encourage the development of the amateur movement."

F.C.C. Notes Vacations and the summer doldrums have gripped F.C.C. recently. The 30-day posting of our proposal to change the 28-Mc. 'phone allocation is expiring without protest, and we may soon expect action. Our Board's proposals concerning emergency communication are under study, but it is a big problem that moves slowly, needing to be coordinated with the general study recently made by the F.C.C. on this question.

There are now two vacancies on the Commission. At this writing, the leading candidates are said to be the chief engineer, the general counsel, and the telephone rate counsel of the F.C.C. There are other candidates, though, and amongst them is an amateur, Samuel Freedman, W1FJS, of Chatham, Mass., who is said to have the en-

dorsement of four senators. The vacancies may not be filled until after the Congress recesses.

Navy Drills The N.C.R. is putting all of its drill circuits on government frequencies as fast as the amateur stations can obtain crystals for specified government frequencies. We think this is a splendid step, one which will make for more effective drills and at the same time will boost the stock of the N.C.R. and bring more applications.

Hawaiian Traffic Reports have been going around that the F.C.C. has banned third-party amateur traffic between Hawaii and the mainland. The report is not true. In July an article appeared in a Honolulu newspaper in which six amateur stations at Schofield Barracks offered the public a general free message service to the mainland. At the request of the F.C.C. inspector at Honolulu this article was subsequently amended to state that "commercial messages" could not be accepted. There is no change in the F.C.C. regulations, and there is no prohibition on the type of messages that may be handled by amateur stations except that they may not be indecent or profane nor may any compensation be accepted for their handling. "Business as usual."

Headset Earcaps for Smoothing Out Frequency Response

THE ordinary run of headsets of the familiar magnet-and-diaphragm type usually suffer from a restricted frequency range and pronounced peaks within that range. While a "peaky" headset is a distinct advantage for c.w. reception (provided the peak comes at a frequency you like to use) it makes 'phone signals sound tinny and gives a far from accurate picture of the actual modulation on the transmitter. Those who like to receive their 'phone signals on headsets will be interested to know that there are now available special caps, which can be substituted for the regular caps with which the 'phones are equipped, and which smooth out the response curve to make reproduction of voice and music more pleasing.

The new earcaps can be obtained to fit practically all makes of metal-diaphragm headsets, and are constructed with built-in resonance chambers forming an acoustic filter. The space occupied by the chambers makes it necessary to build them somewhat thicker than the ordinary cap, but in other respects the size is the same. The new earcaps are being manufactured and marketed by Poul Jarnak, 65 West 83rd Street, New York City.

A New Quartz Crystal Filter of Wide-Range Selectivity

By Dana H. Bacon,* WIBZR

AS James J. Lamb has pointed out, there are in general use at present two systems of varying selectivity in communication receivers.¹ At the high extreme, the best crystal filters provide a band-width adjustable from about 150 to 2000 cycles at 10 times resonance input; which, while entirely adequate for c.w. telegraph signals, is not wholly satisfactory for 'phone. At the broad extreme, receivers using adjustable i.f. transformers have relatively small selectivity variation, the limits being about 15-kc.

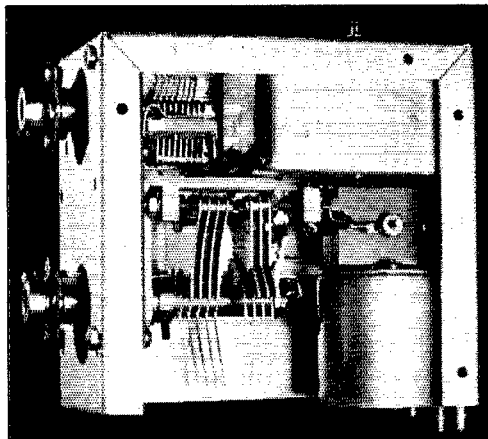

THE COMPLETE FILTER

The selectivity control is the small variable condenser at the upper left, above the differential phasing condenser. The input transformer is at the lower right; above it are the crystal holder and the output transformer.

band-width maximum and 6-kc. minimum. This latter range is of little value in the crowded c.w. bands where the receiver must be capable of separating signals only a few hundred cycles apart.

The ideal receiver obviously would combine the desirable features of both systems, and would, in addition, fill in the gap between 2 and 6 kc. This gap represents an extremely useful portion of the selectivity range, since band widths of that order are required for good quality 'phone reception, and are likewise necessary to bring in the less stable c.w. signals. One method of filling this gap, employing a less selective electro-mechanical type filter unit to replace the high-

selectivity crystal circuit, has been described.² Another and simpler method, employing a single crystal filter element for the full range of c.w. and 'phone selectivity, is the subject of this article.

This new crystal filter has a range of selectivity which is continuously variable between band widths of about 300 cycles and 7 kilocycles. As far as the amateur is concerned, this range is nearly ideal, since high fidelity is actually undesirable in a communication receiver.

Most present-day high-frequency superhets employ an intermediate frequency of 456 kc., or thereabouts. This frequency is unsatisfactory in many ways, as indicated above, but manufacturers have used it in order to obtain the best compromise between selectivity and signal-to-image ratio. Where a crystal is to provide most of the "close-in" or adjacent-channel selectivity, however, it becomes possible to use a considerably higher i.f. with a marked improvement in image rejection. Commonly, the image is higher than the signal frequency by twice the intermediate frequency; that is, 912 kc. higher in a receiver having a 456-kc. i.f. amplifier. At 14 Mc., say, the image will be at 14,912 kc., a difference of but 6.5 per cent. Two signals as close as this cannot be separated by the high-frequency signal circuits unless one or (preferably) two r.f. stages are used. Suppose, now, that the i.f. is made 1560 kc. The image frequency of 14 Mc.

² J. J. Lamb, "And Now We Have Full-Range Superhet Selectivity," *QST*, June, 1937.

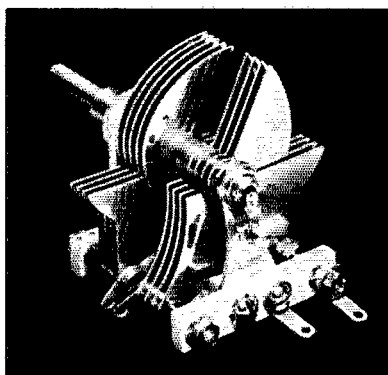

THE DIFFERENTIAL PHASING CONDENSER, "A VARIABLE CONDENSER HAVING ZERO CAPACITY CHANGE"

* 41 Bellington St., Arlington, Mass.

¹ J. J. Lamb, "A New I.F. Coupling System for Superhet Receivers," *QST*, April, 1937.

becomes 17.12 Mc., a difference of 22 per cent, which is sufficient separation to give considerable r.f. discrimination without a preselector.

As a matter of fact, 1560 kc. was chosen as the intermediate frequency for several reasons. It fits in nicely between the 1.75-Mc. band and the broadcast band; i.f. transformers can be economically constructed with characteristics comparable to those designed for lower frequencies and, most important, it is, at present, the practical higher limit of the resonator type crystal. Since the Q of a crystal varies roughly with its mass, it mustn't be made too thin. Furthermore, a 1560-kc. crystal, cut at the proper angle and correctly proportioned, will come very close to giving the ideal selectivity range outlined above.

As previously mentioned, a 456-kc. crystal filter can be made to provide a band width adjustable between 150 and 2000 cycles. Since the ratio of 1560 to 456 is about 3.4, we should expect the high-fre-

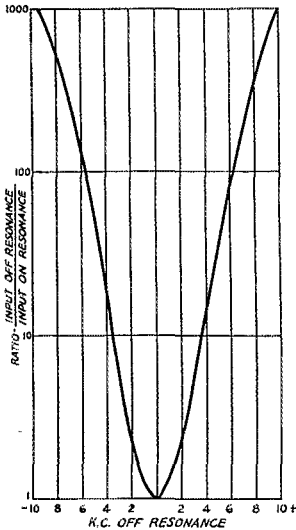

FIG. 3—MINIMUM SELECTIVITY, WITH THE PHASING CONTROL ADJUSTED FOR REJECTION OUTSIDE THE BAND, A CONDITION SUITABLE FOR GOOD QUALITY 'PHONE RECEPTION

quency filter to be adjustable between approximately 500 and 6800 cycles (3.4 times the 456-kc. crystal's band widths); and this is approximately correct, although the actual range can be made much greater.

While the general principles governing the

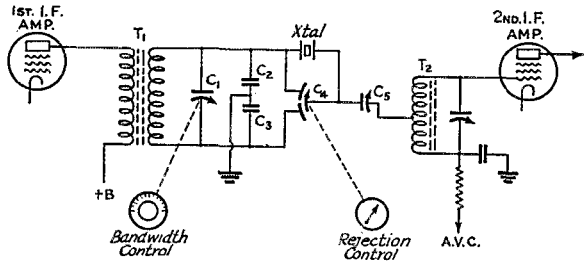

FIG. 1—DIAGRAM OF THE 1560-KC. FILTER

C_1 is the selectivity control, and C_4 is the special differential phasing condenser. Input and output transformers are special types for 1560 kc., and are individually shielded.

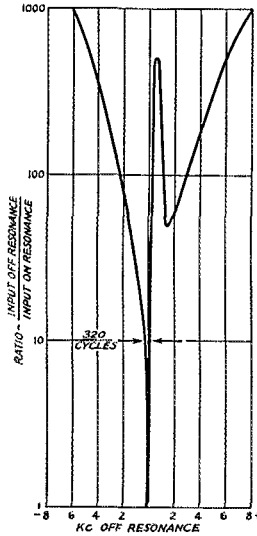

FIG. 2—MAXIMUM SELECTIVITY WITH THE PHASING CONTROL ADJUSTED FOR REJECTION 500 CYCLES FROM THE CRYSTAL FUNDAMENTAL, A TYPICAL CONDITION FOR C.W. TELEGRAPH RECEPTION

operation of the variable-selectivity type crystal filter³ are, of course, the same at any frequency, special precautions must be taken in designing the 1560-kc. unit. For instance, early in the experimental work it was found that the phasing condenser could not be adjusted without affecting the tuning of the input circuit. From the circuit diagram, Fig. 1, it will be seen that the capacity of the crystal holder and phasing condenser are effectively in parallel with the selectivity control, and while the interlocking effect is unnoticeable at low intermediate frequencies, at 1560 kc. it becomes bothersome. The solution to this problem is rather interesting, since it led to the design of a new crystal holder and a new type of phasing condenser.

To reduce the tuning effect as much as possible, the capacity between the plates of the crystal holder must be made small. Unfortunately, the 1560-kc. crystal, being comparatively thin, tends to make this capacity about $2\frac{1}{2}$ times as great as that of a 456-kc. crystal, bringing the total up to about 20 μ fd. when mounted in a plug-in holder of conventional construction. Through the cooperation of the Bliley Electric Company a satisfactory holder was worked out, the plates being small discs having considerably less area than the crystal itself, resulting in a shunt capacity of but 6 μ fd.—even less than that of the low-frequency crystal. The holder, as shown in the photograph, is permanently mounted in the filter unit because cleaning or adjusting is never necessary. Wiring capacity is still further reduced by this means.

(Continued on page 88)

³ For an explanation of variable-selectivity crystal filter operation, see *The Radio Amateur's Handbook*, 14th Edition (1937), pp. 104-106.

Class-B Audio Driver Considerations

Determining Power Requirements and Transformer Characteristics for Low Distortion

By Douglas Fortune,* W9UVC

A GREAT deal has been written about Class-B audio, but somehow very little has been said about the driver stage, which is called upon to deliver perfect quality to the Class-B grids. Since the performance of an otherwise perfect Class-B stage may be impaired by an inadequate driver or by an improperly-designed driver transformer, it is the purpose of this article to point out some of the important points to be considered in the design of a driver stage.

A Class-B audio stage operates with two tubes in push-pull, biased almost to cut-off so that, at any one instant, only one tube supplies power to the output load. In order to operate the Class-B stage efficiently, the grids are driven positive by a certain amount, depending upon the plate voltage of the tube, the plate-to-plate load, the desired power output, and the permissible distortion. Since the grids are driven positive, grid current flows and a certain amount of power—which must be supplied by the driver stage—is dissipated in the grid circuit. This grid current is not a linear function of the grid voltage. At some positive value of the grid signal voltage E , the grid current may be 5 ma.; if the signal voltage is increased to $2E$, the grid current may be 15 or 20 ma., depending upon the actual value of E and upon the plate-circuit conditions. The grid circuit may be compared to a variable impedance which decreases in value as the grid voltage increases. The driver, then, must supply power to a varying load, and if the Class-B grids are to be driven properly, this driving power must be supplied in such a way that the grid voltage does not drop appreciably as the power taken by the grid circuit increases. In other words, the source of power must have good regulation.

Actually, the driving source is not perfect. However, with suitable driver tubes and with a properly-designed transformer, it is possible to obtain a driving source with sufficiently good regulation for satisfactory operation. Just as the load line of only one tube is considered in determining Class-B output, similarly the grid circuit of only one tube needs to be considered in calculating the driving power. In Fig. 1 is shown the equivalent circuit of a single Class-B grid. The driver stage may be considered a source of voltage E of perfect regulation which supplies power

through $\frac{2R_p}{N^2}$, the equivalent resistance of the driver tubes. R_t is the resistance introduced by the driver transformer, which is usually small, and R_g is the instantaneous impedance of the grid circuit, which varies from an infinite (in the case of Class-B tubes operating with fixed bias) to a very definite value. In order to maintain the voltage E_g constant regardless of the value of R_g , the resistance $\frac{2R_p}{N^2} + R_t$ must be small compared to R_g . The actual value of $\frac{2R_p}{N^2}$ is the driver tube plate impedance referred to one-half the secondary; and in the case of a push-pull driver, it is

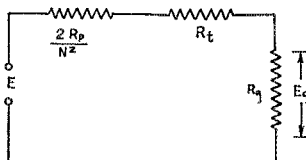

FIG. 1—EQUIVALENT CIRCUIT OF ONE CLASS-B GRID

E is the audio-frequency voltage developed by the driver tubes referred to one side of the transformer secondary, E_g the voltage acting at the Class-B grids, R_g the grid impedance of one Class-B tube, R_t the resistance of the transformer (with primary referred to one side of the secondary), and $\frac{2R_p}{N^2}$ the driver plate resistance referred to one side secondary.

equal to the plate resistance of both tubes divided by the turns ratio squared of the driver transformer. This ratio is figured from the total primary to one-half the secondary. It may be seen that in order to reduce the resistance of the source, the driver tubes must have low plate resistance, the driver transformer should have as high a step-down ratio as possible, and the ohmic resistance of both the primary and the secondary of the driver transformer should be small.

It is the function of the driver transformer to reflect into the plate circuit of the driver tubes a load of such value that the required driving power is just developed with full excitation to the driver grids. If this is done, the driver transformer will have as high a step-down ratio as is consistent with delivering the necessary voltage to the Class-B grids. If the step-down ratio is too great,

* Thordarson Electric Mfg. Co., Chicago.

the driver plate load will be so high that the required driving power for the desired power output cannot be developed, and as a result the Class-B output will be low. If, on the other hand, the step-down ratio is too low, the Class-B output will be high, but the driver regulation will be poor because of the decrease in the value of N^2 in Fig. 1.

It is necessary in the design of a Class-B stage with a relatively small driver to make a compromise between power output and distortion. Distortion will result if the maximum output of

plate voltage 1000 volts, and the bias 55 volts. The load line corresponding to 12,500 ohms is shown at AB . Since the power output is 100 watts, the dynamic peak current is found to be 252 ma.

from $\frac{I^2 R}{2} = 100$, in which R is 3125 ohms. The required positive grid voltage is found at the point X , the intersection of the load line AB and 252 ma. This is approximately +95 volts. If the line XY is followed, it will be found that at the point Y , where the grid voltage is 95 volts, the grid current is 55 ma. Since the tube is biased negatively 55 volts, the total secondary swing is $55 + 95$ or 150 volts, and the peak driving power is $150 \times .055$ or 8.25 watts. The approximate average driving power is 4.12 watts—approximate because the grid impedance is not constant over the entire cycle.

Obviously, there are many audio stages which can deliver a peak power of 8.25 watts; however, economic reasons dictate the use of the smallest tube which will give satisfactory results. A good power tube on the market at the present time is the Type 2A3, which has a plate resistance of only 800 ohms. A pair of Type 2A3 tubes in push-pull, then, is the logical choice to be used as drivers for the Type 800 tubes. The turns ratio of a suitable transformer to couple two Type 2A3 tubes in push-pull to the grids of the Type 800 tubes in Class-B can be calculated from the curves given.

In the following discussion the driver tubes are assumed to be operating strictly Class-A, and the maximum excitation to the drivers is just below the point of grid-current flow. The plate voltage of the Type 2A3 tubes is assumed to be 300 volts and the grid bias -62 volts. The peak power developed in the primary of the driver transformer is approximately

$$2R_L \left(\frac{\mu E_g}{R_p + R_L} \right)^2$$

in which μ is the amplification factor of the tube (in this case 4.2), E_g is the peak grid swing (62 volts), R_p is the plate resistance of one tube (800 ohms) and R_L is one-half the plate-to-plate load on the drivers. If the power is assumed to be equal to 8.25 watts, the value of R_L is found to be approximately 14,500 ohms.

The peak voltage developed across the total primary is:

$$2R_L \frac{\mu E_g}{R_p + R_L} \text{ or } 492.5 \text{ volts}$$

and the turns ratio of the driver transformer, total primary to one-half the secondary, is

$$\frac{492.5}{150} \text{ or } 3.28:1.$$

The regulation of the driver stage may now be figured. The maximum voltage which can be

(Continued on page 88)

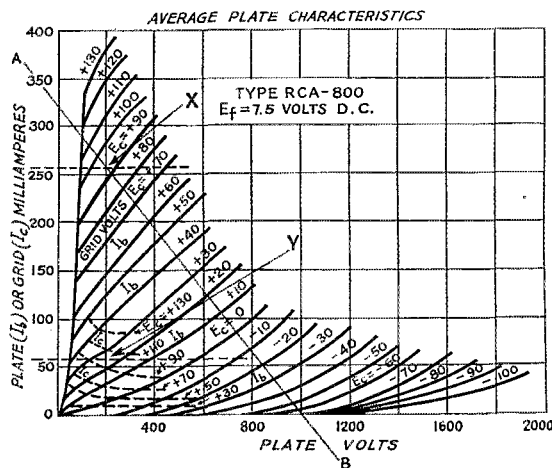

FIG. 2—CHARACTERISTIC CURVES OF THE TYPE 800 TUBE, USED AS AN EXAMPLE IN THE TEXT

the driver stage is about the same as the required Class-B driving power. In this case, to lower the distortion it is necessary to use a driver transformer with a higher step-down ratio and to reduce the Class-B output. On the other hand, if maximum Class-B output with low distortion is desired, a larger driver stage is required. Usually if the driver stage is capable of delivering about three times the required driving power, the regulation will be good. If the grid impedance does not change appreciably, the distortion will be low; however, this condition usually arises when the ratio of minimum plate voltage to positive grid voltage is relatively high, and thus the tubes are not operating under conditions of maximum power output. If more power output is desired, the grids are driven harder by a transformer with a lower step-down ratio and more distortion results, not only because the equivalent resistance of the driving source has been increased but also because the grid impedance has decreased.

In Fig. 2 are shown the plate and the grid characteristics of the Type 800 tube. The driving power required for an output of 100 watts may be calculated from the curves given. The plate-to-plate load for this condition is 12,500 ohms, the

A Six-Band Three-Tube Transmitter

A Compact 100-watt Rig for C.W. or 'Phone

By A. H. Riesmeyer,* W8CHT

THE interest of the majority of amateurs to-day lies in transmitters which are simple and inexpensive, flexible in band shifting, have good performance at the higher frequencies and give fair output on all bands. How often have you been QSO on one band but wished to change to another only to find that the changeover required a long time and fussing around—or else that the layout of the transmitter was such that it was impossible to do so? That was my experience for a number of years. In the past two years I have been changing the rig from one line-up to another, as often as the exchequer would allow, until to-day I feel that here is an

good. A 6A6 could be substituted for the 53 to reduce the number of filament circuits. Either fundamental or harmonic output of the 53 is selected by means of a small jack-switch located just beside the doubler tank circuit. The complete circuit diagram is given in Fig. 1.

The 53 is capacity-coupled to the buffer-doubler stage, the tube in which is an 807. Capacity-coupling is used throughout and can be made to work just as efficiently, with less monkey business and less equipment, as other methods of coupling, provided the impedances are fairly well watched. Now this buffer-stage to my mind is the important part of the outfit. Any

final amplifier tube will work fairly well, even on high frequencies, if there is sufficient driving power. But how can you get sufficient driving power on high frequencies without a lot of stages? That's the catch in many an outfit. Of course, screened pentode tubes could be used but their price is relatively high. When the beam-power tubes were introduced they did a lot to solve that problem. Then another consideration was neutralizing a buffer stage when only low excitation was available.

With the 807 these difficulties are overcome, and if proper constructional details are observed good output is obtainable and

neutralization is unnecessary—which is a big help. The 807 requires very little excitation; a matter of 0.25 watt to get maximum output, which is about 25 watts at 400 volts on the plate. When too much excitation is applied the output is slightly decreased. The bias for this tube is obtained through a 50,000-ohm grid resistor. When the tube is going to be operated only as a straight amplifier this resistor may be reduced to 25,000 ohms, but the higher value is used in this rig because the stage is sometimes used as a doubler, depending on the crystal used and output frequency desired. The output of the tube is excellent as a doubler.

The buffer stage drives an 808 in the final

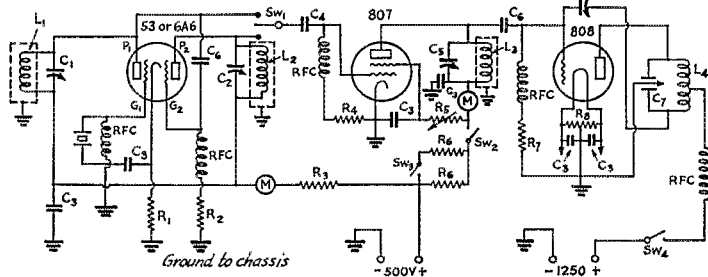

FIG. 1—CIRCUIT DIAGRAM OF THE ALL-BAND TRANSMITTER

- C₁—100- μ fd. variable, receiving type.
- C₂—50- μ fd. variable, receiving type.
- C₃—0.01- μ fd. mica.
- C₄—100- μ fd. mica.
- C₅—100- μ fd. variable, receiving type.
- C₆—50- μ fd. variable, receiving type.
- C₇—75- μ fd. per section split-stator transmitting condenser.
- NC—Neutralizing condenser (National NC-800).
- R₁—1000-ohm, 5-watt.
- R₂—25,000-ohm, 2-watt.
- R₃—10,000-ohm, 10-watt.
- R₄—50,000-ohm, 10-watt.
- R₅—15,000-ohm, 10-watt variable.

- R₆—5000-ohm, 25-watt.
- R₇—7500-ohm, 10-watt.
- R₈—100-ohm, center-tapped.
- SW₁—Jack switch, s.p.d.t.
- SW₂, SW₃—S.p.s.t. toggle switches.
- RFC—Short-wave chokes, (National R-100).
- L₁, L₂, L₃—See coil data, Table I.

outfit that will do its stuff. It is simple and inexpensive, easy to shift from one band to another, and covers all frequencies from 1.7 to 56 Mc. with 125 watts input on 'phone.

THE TUBE LINE-UP

The first thing that such a transmitter must have is an oscillator and frequency multiplier incorporated in one stage. This can be easily taken care of by any number of tubes and circuits. In this outfit a 53 is used in a conventional oscillator-doubler circuit. This tube functions very well and has high harmonic output, and if the plate voltage is kept fairly low its stability is

* New Kensington, Penna.

Class-C stage. At the time this tube was purchased there was a choice of a number of tubes on the market which have similar characteristics. I'll admit that the only reason for choosing it was the arrangement of the grid and plate leads, the one coming out at the lower side and the other out at the top, which made it easy to arrange parts for short leads. There isn't anything exceptional about this stage as it is the conventional plate-neutralized, split-stator plate tank circuit with grid leak bias. The arrangement of the parts should be carefully noted as this is important for high-frequency operation.

POWER SUPPLY REQUIREMENTS

Only two power supplies are used; one which delivers about 500 volts to the oscillator and buffer and another 1250 volts to the final. The lower-voltage power supply is really much larger than necessary, and it will be noted in Fig. 1 that the 53 oscillator is supplied through a 10,000-ohm resistor, and the 807 buffer is supplied through two 5000-ohm resistors. These latter two resistors are used either in parallel to give a resistance of 2500 ohms, or with one cut out, in which case the resistance is 5000 ohms. The voltage on the oscillator is 225 volts and buffer at highest resistance 325 volts and at the lower value 425.

CONSTRUCTIONAL DETAILS

The front panel is 14 inches by 19 inches for

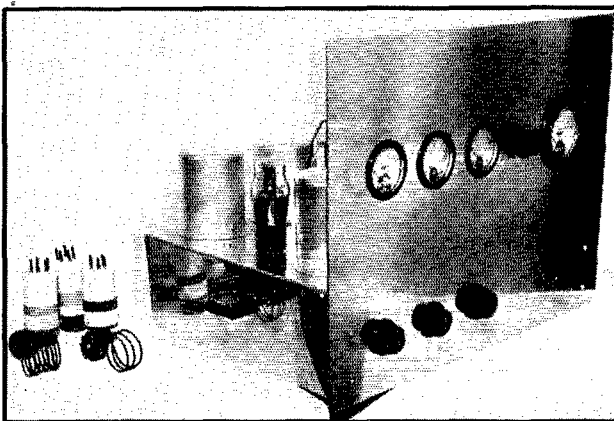

FIG. 2—THE SIX-BAND THREE-TUBE TRANSMITTER

Using a 53, 807 and 808. The coils on isolantite forms are 160-, 80- and 40-meter oscillator coils; the air-wound coils are 20- and 10-meter coils for the doubler or buffer.

relay rack mounting (whenever I get the rack built!) and the sub-panel is 4 inches by 13½ inches by 17 inches. These are made of Alcoa aluminum.

On the front panel can be seen (reading from left to right, Fig. 2) the oscillator plate, buffer plate, final grid and final plate meters, with the final tank condenser knob set between the last two. Below the meters are the oscillator, doubler and buffer tuning knobs, with the buffer plate switch at the lower right. All the parts for the first two stages are mounted below the aluminum sub-panel and wired with bus-wire for the sake of rigidity. This permits isolation of the oscillator-doubler and buffer tuning. The only parts for the 808 stage mounted below the sub-panel are the filament bypass condensers and the plate r.f. choke. The crystal is plugged in from the left side of the sub-panel opposite the 53 tube. With the help of an adapter made from an isolantite socket with banana plugs soldered on the two lugs, any type of crystal holder may be used.

All coils (see Table I) are plugged in from the top of the sub-panel. The 160-, 80- and 40-meter coils for the oscillator-doubler and buffer stages are wound on isolantite coil forms while the 20- and 10-meter coils for these stages are air-wound with No. 12 enamelled wire soldered into cut-off tube bases. All of these coils are shielded with aluminum coil shields.

The 80- and 160-meter coils for the final stage are wire-wound on bakelite coil forms. The 40, 20, 10, and 5-meter coils are "wound on air"

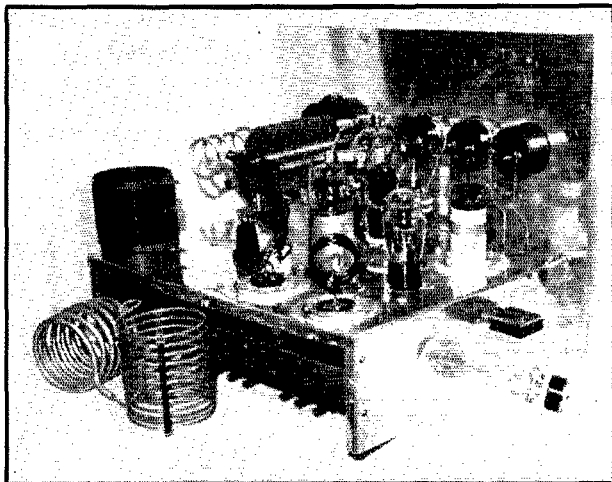

FIG. 3—THIS VIEW INDICATES THE ARRANGEMENT OF PARTS ON THE CHASSIS

The final tank coils for 80, 20 and 10 meters are visible in this photograph. The 5-meter coil is plugged in at the tank condenser. The plug-in adapter for crystal holders having tube-base prongs also is shown.

using wire or aluminum tubing. These coils plug into large contacts mounted directly on the final tank condenser.

TUNING PROCEDURE

The tuning procedure is very simple. After deciding what crystal is to be used and output

tuned to resonance. The dummy antenna is then coupled to the final tank and the transmitter is tested to determine if everything is functioning properly. If so (and I have never had a time when it failed) the transmitter is ready to put on the air. Any type of antenna coupling may be used. In my case I use three types, depending on the frequency in use.

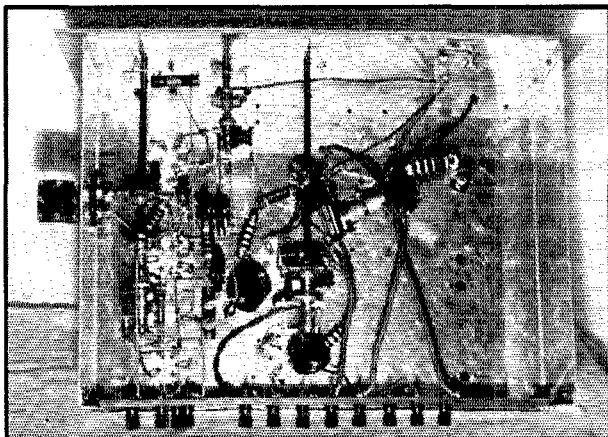

FIG. 4—A BOTTOM VIEW, SHOWING THE VARIOUS COMPONENTS USED IN THE OSCILLATOR-DOUBLER AND BUFFER STAGES

frequency desired the proper coils are plugged in and the tubes lighted. If the doubler section of the 53 is not to be used, its plate coil is not plugged in and the output switch, *SW*₁, is connected to the oscillator output. Voltage is then applied to the 53 and the oscillator tank condenser tuned to resonance. If the doubler is used its circuit is then adjusted. When this is done, the plate voltage switch, *SW*₂, to the 807 is closed and the plate tank condenser then tuned to resonance. This is readily observed by either the plate milliammeter on the 807 or the grid meter to the 808. With the set so far in operation the 808 circuit is neutralized by adjusting *NC* in the usual manner. When once carefully done I have found that it is unnecessary to repeat the neutralizing operation when shifting bands. Next, the plate voltage is applied to the 808 and the tank condenser

MODULATOR UNIT

Any modulator that will give between 55 to 60 watts of audio may be used with this outfit to modulate it 100 per cent. I have not shown a photo of my modulator unit as it is the conventional Class-A type using a pair of Type 845's in parallel. This unit is separately mounted at the present time in an aluminum box and has been in use for about eight years!

PERFORMANCE

The transmitter has been tuned up on 5 meters using a 20-meter crystal in the oscillator and quadrupling to 5, amplifying in the 807 and 808; or doubling to 10, and then doubling to 5 in the 807. In the latter method, slightly more plate voltage is required on the 807 to get sufficient excitation to the 808. This is a little hard on the tube but it seems to take it and helps prevent parasitic oscillations—when the 807 is used as a straight amplifier—which were encountered when first using this band. Since then, a change was made in the grid choke and by-pass condenser on the screen grid. Outside of getting it operating properly on this band I'll admit I haven't done much down there but it ought to function well.

On the other bands it has been "duck-soup." It's really a pleasure to change over from one band to another when the QRM gets tough. Over the weekends, when I have a chance to operate during the day time while 10 or 20 are "hot" I'm down there until the band goes out, then shift to 75 or 160 as the urge comes.

It must be remembered that a transmitter is no better than its antenna system. If some fellows would spend a dollar or two for a few feet more wire and some insulators, many dollars in tubes and power supplies would be saved, with resultant saving in electric bills and QRM.

TABLE I—COIL DATA

Band	<i>L</i> ₁	<i>L</i> ₂	<i>L</i> ₃	<i>L</i> ₄ Final
	Oscillator	Doubler	Buffer	
	Turns			
56 Mc.	—	—	—	Al. T., 7t, 1¼" dia. 3¼" long
28 Mc.	—	3*	3*	Al. T., 7t, 3" dia. 3¼" long
14 Mc.	7	7	8	No. 8 wire, 15t, 3" dia. 3¼" long
7 Mc.	12**	12**	14**	No. 14 wire, 30t, 3" dia. 3¼" long
3.5 Mc.	22**	22**	26**	No. 14 wire, 60t, 3¼" dia., 3¼" long
1.75 Mc.	44**	—	50**	No. 18 wire, 85t, 5" dia. 3¼" long

* No. 12 enamel wire air wound 1¼" diameter.
 ** No. 22 enamel wire on isolantite coil form 1¼" diameter.
 † Wound on bakelite coil form.
 Al. T.—Aluminum tubing.



Please note that all cards intended for any country whose prefix starts with "F" can be sent via the French Bureau: Réseau des Emetteurs Français, 6 Square de la Dordogne, Paris, 17.

However, cards for French Morocco (CN) should be sent directly to A.A.E.M., B.P. 50, Casablanca, Morocco.

Circuit Equalizing to Improve Receiver Performance

An Easily-Applied Method for Checking Coils and Condensers without Laboratory Equipment

By John Gluck,* W8MYB

MANY excellent articles on superheterodyne construction have appeared in *QST* as well as in the *Handbook*. Other articles have discussed selectivity, methods of injection and other phases of receiver design. Perhaps a periodic review of these would be well worth the time so spent.

Even though an amateur has followed the details of a receiver construction article, the results produced, in terms of signals, sometimes fall short of expectations. To be sure, specifications of the components, numbers of turns, etc., for coils, and photographs to show a highly desirable layout always are included, but no two constructors will wire a set in exactly the same manner. The stray capacities will not be identical. Ways to equalize these so that circuits will track accurately, thereby making the success of the work less dependent upon good fortune, are seldom mentioned. There is obviously a need for a satisfactory, highly accurate, and yet simple and inexpensive method of inductance equalizing.

Since perfect tracking is essential for realization of the maximum gain a receiver is capable of giving and since noise is a function of the receiver's selectivity, it immediately follows that perfect tracking will improve the signal-to-noise ratio.

Assuming a circuit tuned to a carrier's frequency, let us consider the various factors involved, and study the effect of each on the tracking. The results, in tabular form, will allow a quantitative as well as qualitative inspection to be made.

Let C = the actual capacity of the tuning condenser in $\mu\text{fd.}$ at any particular setting.

C_T = the actual capacity in parallel with C . C_T is fixed in value for a particular coil, and is the sum of the coil's distributed capacity, the stray capacity of the wiring, the input capacity of the tube, and the amount which the padding condenser contributes. By changing the capacity of the padder, the value of C_T may be varied to suit and then left undisturbed.

L = the inductance (in microhenrys) of the coil. On the lower frequencies the coil inductance is so much greater than that of the connecting leads that the latter may be neglected.

The resonant frequency (in kilocycles) of L , C , and C_T in parallel, when the units are as stated above, is given by the formula:

$$f = 159,300 / \sqrt{L(C_T + C)}$$

A PRACTICAL EXAMPLE

Let us assume that the receiver under construction is to have two stages of preselection and a mixer. The three inductances have been found in accordance with the prescribed data. The coils have been mounted or placed in their respective shields so as to simulate actual conditions. It is unlikely that the three coils will have identical values of inductance and distributed capacity, especially with hand winding. Suppose the following conditions to exist:

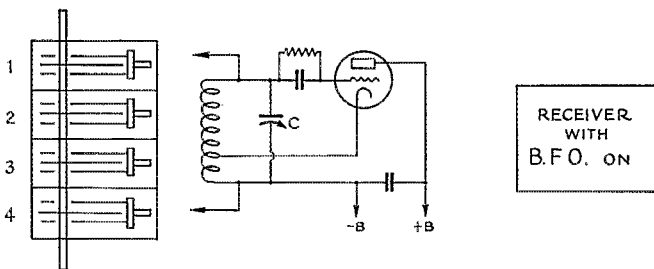

FIG. 1—CIRCUIT USED FOR CHECKING UNIFORMITY OF CONDENSER SECTIONS

A simple oscillator and a separate receiver are all that is needed. The procedure is described in the text.

$L_1 = 110 \mu\text{h} =$ coil in 1st r.f. circuit.

$L_2 = 100 \mu\text{h} =$ coil in 2nd r.f. circuit.

$L_3 = 90 \mu\text{h} =$ coil in mixer circuit.

Let the padding condenser of each circuit be adjusted so that $C_T = 20 \mu\text{fd.}$ The four-ganged variable condenser is to have a minimum of $20 \mu\text{fd.}$ and a maximum of $180 \mu\text{fd.}$ For the time being we may assume that all sections of the ganged condenser have identical capacities at all settings. If our condenser is set for $C = 30$ then

$$\begin{aligned} \text{1st r.f.} \dots f &= 159,300 / \sqrt{110(30 + 20)} = 2147 \text{ kc.} \\ \text{(A) 2nd r.f.} \dots f &= 159,300 / \sqrt{100(30 + 20)} = 2252 \text{ kc.} \\ \text{Mixer} \dots f &= 159,300 / \sqrt{90(30 + 20)} = 2375 \text{ kc.} \end{aligned}$$

* Kamesha, N. Y.

The oscillator used for the condenser test is again pressed into service. Besides this a detector such as a 56 or 27 or 76 is needed. This may be made up in bread-board style, using the circuit shown in Fig. 2.

The "B" voltage may be any value from 45 to 250. The "C" bias should be so adjusted that cutoff is just about realized. Approximately 0.1 mil is correct, when the oscillator is not connected. When the oscillator is connected and its frequency varied so that circuit L_1CT_1C is resonant at the oscillator frequency, an increase in plate current will be observed. Maximum current indicates the best possible adjustment.

With the first r.f. coil in place as shown in the diagram, proceed as follows:

1. Set C at a low value—say 30 μfd .
2. Set CT_1 at about its mid-point (half capacity).
3. Vary the oscillator frequency for maximum plate-current reading.
4. Remove L_1CT_1 and place L_2CT_2 in its place.

Do not change the setting on the oscillator nor on C .

5. Vary CT_2 for maximum reading on the milliammeter.
6. Remove L_2CT_2 and insert L_3CT_3 in its place.
7. Vary CT_3 until the meter indicates the maximum reading.

The procedure outlined and performed by the seven steps insures that L_1CT_1 , L_2CT_2 , L_3CT_3 , when shunted by fixed value of C , are each resonant to the same frequency.

Now, with the first r.f. coil in place as shown in the diagram, proceed as follows:

1. Set C to some value near its maximum—say about 150 μfd .—and read carefully the dial setting.
2. Vary the oscillator setting until the meter indicates maximum current.

Do not touch the oscillator setting nor touch CT , CT_2 , CT_3 but make all changes by means of C .

3. Remove L_1CT_1 and place L_2CT_2 in its place.
4. Vary C until the meter indicates maximum current. Read dial setting of C carefully.
5. Remove L_2CT_2 and place L_3CT_3 in its place.
6. Vary C until the meter indicates maximum current and read dial setting of C carefully.

If the three readings of C are identical, then the values of L_1 , L_2 , L_3 are also identical, as are CT , CT_2 , CT_3 , and we need go no farther but accept the coils as satisfactory. However, such is seldom the case. Table (B) shows the results produced by following the seven steps outlined in the previous section, while Table E shows the results produced by following the six steps just outlined. By inspection of Table E, it is at once apparent that larger values of C indicate a lack of inductance.

	L	CT	C	f
1st r.f.	110	15.5	150.0	1183
(E) 2nd r.f.	100	20.0	162.0	1183
Mixer.	90	25.5	176.5	1183

The procedure now is to remove turns from L_1 and L_2 . If these coils have discs located in their fields, the inductance may be reduced by inserting the discs farther into the coils. Withdrawal of the discs will result in the increase of the coil's inductance. Having made such adjustments, the entire operation is repeated again as outlined under the seven-step procedure, then followed by six-step procedure.

PRECEDING STAGE EFFECTS

For the sake of simplicity, the effect of the antenna or tube of the preceding stage has been omitted. Actually these effects are too great to be taken so lightly. The primary itself, as well as the tube's output impedance which the primary serves to introduce into the tuned circuit, alter the characteristics of the tuned circuit.

Inductances L_2 and L_3 , each with its associated primary, is treated just as though no primary were present. However, in order that the effects may all be taken into account, the actual connections should be made as shown in Fig. 3.

The oscillator output is impressed between grid and cathode of the 6K7, whose plate circuit is coupled to L_2 , which is tuned by C until the meter gives a maximum reading. Inductance L_3 may then be substituted and the procedure is exactly as described for the three inductance in our assumed case.

In equalizing the inductance for the antenna or preselector stage, a compromise must be made. It is hard to believe that there are two receiving antennas identical in electrical characteristics, or that a receiver will at all times be connected to the one antenna and that the feeders will not be subject experimentation. For these reasons, at least, it seems advisable to consider the feeders to look like a resistance of anywhere between 200 and 500 ohms.

A non-inductive resistor of a value between the above limits should be connected across the primary of the antenna tuning coil, L_1 . This will simulate antenna loading fairly well. The milliammeter may now be put in the first r.f. plate circuit to note maximum plate current when resonance occurs. In order that bias shall not have to be set too high and that the moderate voltage available from the oscillator shall be sufficient, it is suggested that the 6K7 be replaced by a sharp cut off tube like the 6J7 when making adjustments in L_1 .

Inductance L_1 may be inserted in the same position as L_2 and L_3 if the tube load is replaced by the non-inductive resistor when readings on L_1 are being taken.

It might seem, speciously enough, that this is

(Continued on page 90)

Adding Super-Regeneration to an SW-3 for Use with the High-Stability 56-Mc. Converter

By Byron Goodman,* WIJPE

LAST month a converter¹ was described that used an i.f. channel of 20.5 Mc., and an SW-3 was suggested for the i.f. amplifier. After using the converter for a few evenings it became quite apparent that the receiver was too selective for many of the present-day five-meter 'phone signals. While it was a pleasure to use it with a stabilized signal, on modulated-oscillator signals the regeneration of the SW-3 had to be backed down so far, to reduce the selectivity, that the gain of the system was inadequate. It had been thought at first that the regeneration of the receiver could be pushed far enough to make it a sort of "self-supering" affair, but this proved somewhat unsatisfactory; so an external quench oscillator was built to be used with the receiver when super-regeneration was to be employed. It is a simple affair, and the installation takes only a few minutes. It doesn't change the performance of the receiver on straight regenerative operation, and the change from regeneration to super-regeneration is accomplished by the flick of a switch.

The external oscillator was built quite simply, on a small piece of aluminum cut and bent to form a chassis $2\frac{1}{2}$ by $3\frac{1}{2}$ and $1\frac{3}{4}$ inches deep. A hole was drilled on the top to take a five-prong socket, and the coils, condensers and resistors were mounted within the chassis. Five leads were brought out as shown in the diagram, and the unit was bolted on to the right-hand side of the SW-3. The five leads were run through the side of the receiver cabinet and connected as shown in the diagram. The only necessary change in the SW-3 is to remove the two leads (from the regeneration control and by-pass condenser) from the screen-grid connection on the detector tube socket and add a 0.002- μ fd. mica condenser from the screen-grid to the ground connection that is located conveniently near. The two leads removed from the screen-grid are connected to the lead coming from the switch in the external oscillator, the lead coming from the plate of the external oscillator is connected to the detector screen-grid terminal, the ground connection is brought through, and the heater leads from the external oscillator are connected at the point where the battery cable of the receiver comes in to the set.

With the switch on the external oscillator set

at "A" the SW-3 should function exactly as before, except that possibly regeneration will take place at a slightly different setting of the regeneration control because of the additional current passing through this resistor. When the switch is moved to the "B" position, the receiver should immediately break in to the familiar hiss characteristic of all super-regenerative receivers. The

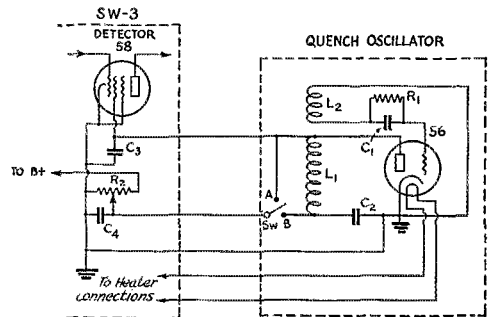

FIG. 1—CIRCUIT OF THE QUENCH OSCILLATOR ADAPTED TO THE SW-3

L₁, L₂—Windings of National OSR quench oscillator unit. The small coil is used in the grid circuit, hence the "B" lug is connected to the tube grid, the "G" terminal going to the tube plate.

R₁—50,000-ohm $\frac{1}{2}$ -watt carbon resistor.

R₂—Regeneration control of SW-3.

C₁—0.001- μ fd. postage-stamp mica condenser.

C₂—0.01- μ fd. paper condenser, 200-volt rating.

C₃—0.002- μ fd. postage-stamp mica condenser, added to receiver. (See text.)

C₄—0.5- μ fd. paper condenser. Part of original SW-3. (See text.)

Sw—Single-pole double-throw toggle switch.

degree of hiss should be continuously variable with the regeneration control on the SW-3. The first time the external oscillator was tried, the 9-15 meters general-coverage coils were used in the receiver which put 20.5 Mc. at about 145 on the dial, or with almost full capacity in the tuning condensers. This range was used because it was thought that with high-*C* in the detector circuit we would obtain maximum stability. The stability was fine; but when an effort was made to make the receiver "super," it was found that it wouldn't work well at the low-frequency end of the scale, no doubt because of some lack of feedback at this end of the range. So coils covering the next range (13.5-25 meters) were used, bringing 20.5 Mc. at about 15 on the dial. Now the receiver "suped" beautifully. Connecting the converter to the SW-3, we now had a 56-Mc.

(Continued on page 98)

* Assistant Secretary, A.R.R.L.

¹ B. Goodman, "A 56-Mc. Converter of High Stability," *QST*, August, 1937.

With the Affiliated Clubs

FALL is just around the corner. Time soon to brush the cobwebs out of the club rig, oil the hinges on the shack door and round up the local gang from summer hiding for the first meeting of the new season. Incidentally, we'd like to compile a complete list of calls of stations owned and operated by A.R.R.L.-affiliated clubs. Each club should have some way of recognizing other club groups on the air. Will you help? Simply send us the call letters of your club station.

Air Races

The Pylon Judges at the 1937 International Aerobatic Meet, St. Louis, Mo., were radio amateurs—members of the Mound City Radio Amateurs and O.B.P. clubs. A group of amateurs from these organizations installed and manned the efficient communication system used during the three-day meet. W9KFL was chairman of the Mound City crew (W9KFL GVE NBE GDY CCZ HWD TA) while W9BGE headed the O.B.P. gang (W9BGE BEQ EFC EZX AC KEF Fred Althoff, ex-9AOT).

A 3.9-Mc. 'phone transmitter, crystal-controlled and powered from storage batteries and dynamo, was set up at each pylon around which the planes circled. A spot-frequency was used for all pylon transmitters. Receivers were tuned to the 14-Mc. signal of the central station located at the official timer's position between the booths allotted to BC stations. This station kept tuned to the 3.9-Mc. pylon frequency.

One Mound City member and one O.B.P. member formed the operating staff at each pylon. Operators were given credentials as officials of the contest. Their duties were to report any mishap, any attempt at unfair play, or any case where fliers "cut corners" in passing over the pylons. Reports from each pylon would be sent to the central station as each plane passed over; thus, "plane 70 rounding pylon one"; "plane 111 rounding pylon three", etc. It required a marked degree of alertness and efficiency to avoid errors and keep up with the reports as the planes sped around the course. The St. Louis clubs did a splendid job to their own credit and the glory of all of amateur radio.

The Nashville (Tenn.) Amateur Radio Club assisted with communications during the opening of the new Nashville Municipal Airport on June 13th. Portable equipment was set up at the new field to help with communications to Nashville as telephone facilities were limited. 7-Mc. was used. Those participating were W4BM, W4AEE, W4DWS and W4AWB. W4AEE was stationed at

Sky Harbor where all incoming ships landed until the air circus was over. He relayed news of the arrival of all notable fliers to W4BM at the airport.

Questionnaire

Noticing a certain spirit of listlessness among its members, the Framingham (Mass.) Radio Club hit upon the questionnaire idea to try to uncover just what was lacking in the club. A list of twenty-five questions was sent to each member, with the request that he give careful thought to the various points, then answer them frankly adding any constructive criticism he might have. No signature was required to the answers. The results were gratifying. Over two-thirds of the membership returned the questionnaires, the trouble with the club was ascertained and the organization was brought to normal. Here are some of the questions asked: Do you feel that the club seems to divide up into friendly groups? . . . Can you personally afford the present dues? . . . Do you dislike talking in front of a group? . . . Are the business meetings too long? . . . Is there enough entertainment? . . . Is there enough variety? . . . Are the present meeting nights convenient for you? . . . Do you approve of the Constitution of the club as written?

Trophy

The Finger Lakes Transmitting Society (Auburn, N. Y.) has inaugurated an annual silver cup trophy to be awarded each year to the amateur in the club having the best station, considering equipment and performance. W8BFG was the first winner—for 1936. The trophy will next be awarded in the fall of this year. If the same person retains it three successive years, it becomes his permanent property. In that event the club will start a new "best station" award.

Auction

Here's an idea for raising money that netted the Oakland (Calif.) Radio Club \$30 clear . . . a used parts auction. Equipment is donated by the members, and must all be usable gear. Each piece of apparatus is securely wrapped and bought "sight unseen."

Get-Togethers

Among the most recently reported club affairs we find the following: The Hi-Q Radio Club of Lynn, Mass., held its second annual hamfest at the Topsfield Fair Grounds on July 10th. A program of outdoor sports was topped off by a big

(Continued on page 30)

How Would You Do It?

56- and 28-Mc. Antennas for Mobile Work

As might be expected, response to Problem No. 7 was not so great as that aroused by previous problems because it was of greatest interest to the rather limited group working with high-frequency mobile problems. While it cannot be said that any of the ideas submitted were either new or novel, the prize-winning solutions describe simple systems which are worthy of publication because they have demonstrated their effectiveness in actual use and because they may serve as sound examples for those who are getting into mobile work for the first time.

First Prize Solution

By George M. Grening, W/6HAU

IN regard to the July problem, which confronts our hero in devising a 28- and 56-megacycle antenna for his mobile transmitter without incurring the wrath of his XYL, I present the following type which solved a similar problem for me.

Briefly passing over the obvious solution of getting the XYL so interested that she would willingly ignore a few holes in the metal (this has worked out more than once), we pass along to Fig. 1. The antenna proper consists of one of the many types of collapsible fishpoles which are flooding the broadcast car receiver market. Most of these are designed to be clamped to the rear bumper and fully extended approximate eight feet or more in height. On 28 Mc. it is fully extended and on 56 Mc. it is collapsed to four feet or so.

The feed system is surprisingly simple and is the result of a number of years experimenting with all types. A piece of concentric line is connected with the inner conductor to the base and the outer grounded to the car body. This may then be run underneath the rear of the car and into the body by any convenient opening or a hole may be drilled underneath the mat, alongside the edge, making it invisible except on a minute inspection. While the regular copper tubing with isolantite spacers is excellent, a flexible type, readily obtainable, is

even better from a mechanical standpoint. Still another alternative is to use E01 or similar cable, grounding one conductor. In my own installation however, I use spark plug cable, threaded through hollow loom which has a braid over the outside. This type of loom is commonly used to provide a low capacity lead-in on automobile receivers. Since the outer conductor is at ground potential, it may be threaded around corners or fastened to the frame en route to the inside of the body without any loss.

At the transmitter end, a one-turn coupling coil is made of No. 10 or larger wire to make it self-supporting and is placed around the outside of the final tank coil. This single turn loop should have a diameter at least twice that of the final coil, giving very loose coupling. A 100- μ fd. variable condenser is placed in series with the inner conductor at the set end. The outer con-

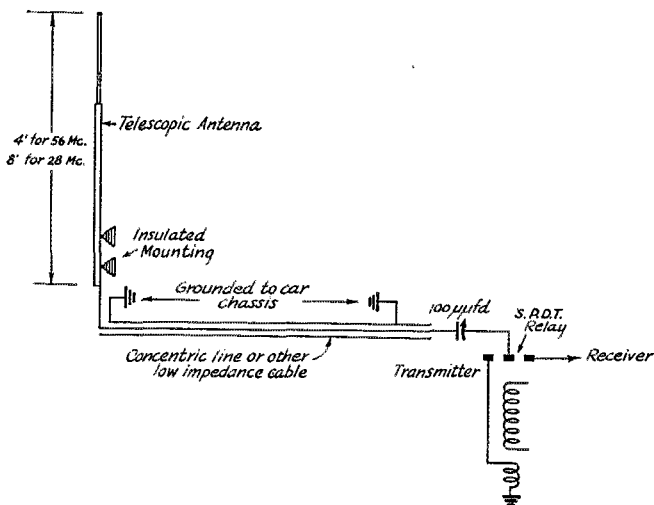

FIG. 1—CONCENTRIC LINE FEEDER WITH QUARTER-WAVE ANTENNA COUPLING IS ADJUSTED BY MEANS OF THE SERIES CONDENSER

ductor is grounded to the chassis of the transmitter which is well grounded to the body. If the final is push-pull, place the loop around the center of the coil and if single ended, around the low potential end of the coil. In the rare event that not enough coupling is in evidence, increase the number of turns or slide the loop closer to the hot end of the coil. The final adjustment consists in tuning the condenser until the antenna loads the final to a maximum. An exact adjustment of

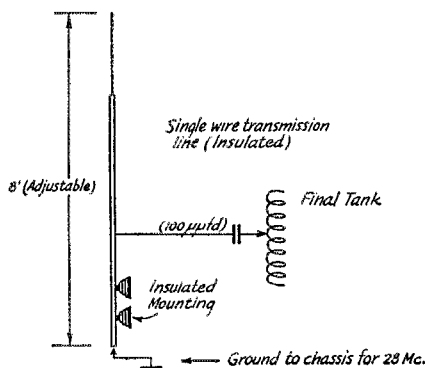

FIG. 2—SINGLE-WIRE MATCHED IMPEDANCE FEEDER WITH QUARTER- OR HALF-WAVE ANTENNA

Problem No. 9

OUR Hero has decided to do something very definite about the junk that he has accumulated. He has all manner of condensers, resistors, tubes, wire, coil forms, chunks of metal, screws and all the other gadgets that find their way into the ham shack. At the moment they are scattered around the room and in the attic and it usually takes half an hour to find that little brass angle piece that he just *knows* he saw somewhere last week. He needs a really practical plan for a junk box—something that can be rigged cheaply and in quick time but something that will really be convenient. O. H. is the sort of fellow who works fast and often. He has seen lots of these pretty work-shops with a dinky box or a special hook for everything but he has noted that if their owners actually did a lot of constructional work and experiment it would take twice as long to keep the shop in shape as it takes to do the work. He knows that there must be lots of hams who hit the happy medium—who do plenty of work and still manage to adhere to some system which makes the right junk available at the right moment. He feels that they could give him full details of the ideal junk box arrangement.

antenna load may be made as outlined above, or by detuning the antenna condenser.

Careful field strength tests show this unusual type to be the most efficient of any tried. Another big advantage of it lies in the fact that antennas as short as five feet may be used successfully on 28 Mc. Incidentally, transcontinental transmissions have been made from a car using this type, with 15 watts input.

For five meters or 56 Mc. the only adjustments necessary are to collapse the fishpole to the proper height and possibly a slight readjustment of the antenna condenser. It is sometimes possible to eliminate this condenser, particularly if the antenna height is correct for the operating frequency.

Second Prize Solution

By Bernard T. Ellis, Jr., W2I2P

THE antenna system shown in Fig. 2 can be installed by any ham whose XYL won't allow any holes in the tinware. It consists of a three-eighths inch, eight-foot dural rod or tube. It is fastened to the car by means of rubber suction cups borrowed from the windshield defroster. Brackets to hold the rod vertical can be designed to suit the particular shape of the car.

The method of bringing the feeder through the window is borrowed from that used by many hams on their home rigs. A piece of wood is cut to fit between the top of the rear side window frame and the glass itself. This piece is drilled to permit the passage of a feed-through insulator, and is then enameled in a color to match the car.

The eight-foot rod is tapped 13½ inches from the center as in single-wire feed. On 56 Mc. it is operated as a half-wave single-wire feed antenna. On 28 Mc. the lower end of the rod is grounded to the car body and the system is operated as a grounded quarter-wave Marconi.

Transfer of the feeder from the transmitter to the receiver is accomplished by means of a B eliminator relay, which ordinarily is used to switch the 110 a.c. from the battery charger to the B eliminator. (It is possible that some adjustment of the tap on the antenna may be necessary in changing from 28 to 56 Mc.—Ed.)

The following are listed for Honorable Mention: W1HZK, 80MM, 8QIE, 9RT, 9VTP.

~~Strays~~

Here's a rare one that W9CDE picked up from a local paper:

"THE CRYSTAL BALL DIDN'T WORK"

"The Holbrook Quartette journeyed to Lamar Sunday afternoon with the program for the Lions Club Radio Hour all ready for delivery to a waiting world. As the station prepared to go on the air it was discovered that the crystal ball regulating the kilocycles was overheated because of a contact being stuck, and as a consequence the wavelength would have been away out in the short waves beyond the power of the average radio to pick up. Therefore the program was postponed and everybody concerned came back home."

That crystal sure was hot!

An Electronic Volume Compressor

Easily-Constructed Unit Which Can Be Applied to Almost Any Speech Amplifier

By Robert E. Bullock,* W6MKP and Harry N. Jacobs*

FOR some time we have realized the desirability of incorporating a volume compressor in the speech end of our 'phone rig, but all available methods seemed to be quite expensive and generally required an extensive change in the speech amplifier line-up. Finally, there occurred to us the thought of doing the job electronically, by using one of the variable- μ tubes. We selected the 6L7 pentagrid mixer tube, with its one remote cut-off grid, one ordinary control grid, screen, suppressor, and plate. Around this tube the circuit shown in Fig. 1 was finally derived.

The operation of the circuit is simple. The input voltage—approximately one volt—is fed to the No. 3 grid of the mixer tube through the potentiometer volume control, R_2 . A portion of

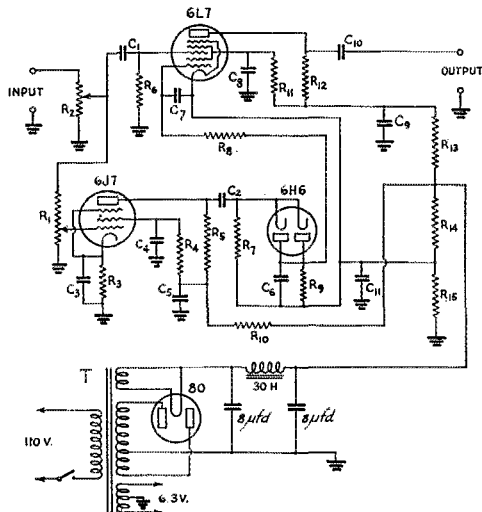

FIG. 1—CIRCUIT DIAGRAM OF THE VOLUME COMPRESSOR

- | | |
|-------------------------------------|---|
| C_1, C_9 —0.1 μ fd. | R_6 —1 megohm, 1 watt. |
| C_3 —10 μ fd., 35-volt. | R_7, R_8, R_9 —0.25 megohm, 1 watt. |
| C_4, C_5 —0.5 μ fd. | R_{10} —50,000 ohms, 1 watt. |
| C_6, C_7 —0.1 μ fd. | R_{11} —25,000 ohms, 1 watt. |
| C_8, C_9 —0.5 μ fd. | R_{12} —0.1 megohm, 1 watt. |
| C_{10} —0.1 μ fd. | R_{13} —50,000 ohms, 1 watt. |
| C_{11} —10 μ fd., 35-volt. | R_{14} —12,000 ohms, 20 watts. |
| R_1, R_2 —1 megohm potentiometer. | R_{15} —150 ohms, 1 watt. |
| R_3 —2250 ohms, 1 watt. | T—Small power transformer to deliver 250 volts and 6.3 volts. |
| R_4 —1 megohm, 1 watt. | |
| R_5 —0.25 megohm, 1 watt. | |

the same voltage is also fed to the grid of a 6J7, pentode connected, through the potentiometer compression control, R_1 . The amplified a.c. voltage

is then fed to the parallel connected plates of a 6H6 diode rectifier, from which is obtained the direct current bias for the No. 1 grid of the mixer tube. An increase in signal strength increases the bias on the 6L7, and thus decreases the transcon-

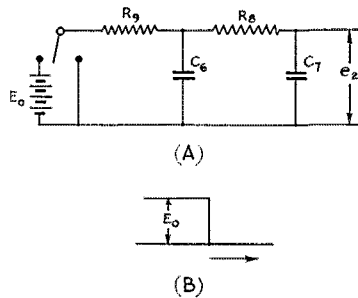

FIG. 2—TIME-CONSTANT CIRCUIT

ductance of the tube as the signal input is increased. By this means a considerable amount of volume compression may be obtained.

The choice of values for the condenser-resistor parallel combination in the diode load circuit (C_6, R_9) is a compromise between two conflicting factors. The time of discharge of the combination must be short enough so that any small signal immediately following a large signal will not be lost because of time lag in the bias-voltage change, but the time must be longer than that required for the lowest-frequency audio wave to vary one-quarter of a cycle from its peak value. This last requirement must be met if the wave-form of the signal is to be maintained.

It is necessary to provide some form of audio filter (C_7, R_8) in the lead to the No. 1 grid of the 6L7; if this is not done, audio-frequency voltage from the 6J7 will be impressed on it. As the audio-frequency voltage from the 6J7 is 180 degrees out of phase with the input voltage, serious waveform distortion will occur if the filter network is omitted. As in the diode load network, the components of the filter are a compromise. If R and C are made too small, waveform distortion will occur. On the other hand, if they are too large, a large time delay and time lag will occur.

Considering the circuit of Fig. 2, if the voltage applied to R_9 is of the form shown in Fig. 2-B, then the voltage across C_7 at time t_2 seconds later is given by the expression:¹

¹ Kellogg and Phelps, "Time Delay in Resistance-Capacity Circuits," *Electronics*, February, 1937.

$$e_2 = 1.17 E_{0e} \frac{- .382t}{RC} = .17 E_{0e} \frac{- 2.611t}{RC}$$

where $R_9 = R_8 = R$, and $C_6 = C_7 = C$.

The above circuit is equivalent to the diode load and audio-filter circuits of the compressor. Hence we may use the formula given above to calculate the time delay introduced by the components used.

In our case $R = .25$ megohms (R_8, R_9)
 $C = .1 \mu\text{fd.}$ (C_6, C_7).

If we let $t = .075$ seconds,

$$\text{then } \frac{e_2}{E_0} = .37$$

Thus it is seen that the bias applied to the grid will be reduced to 37 per cent of its original value, E_0 , in 0.075 seconds. This time delay proved to be sufficiently small to give smooth compression.

Considering the effect on the wave-form, the time required for a 100-cycle audio wave to pass from a peak value to zero is 0.0025 seconds, the

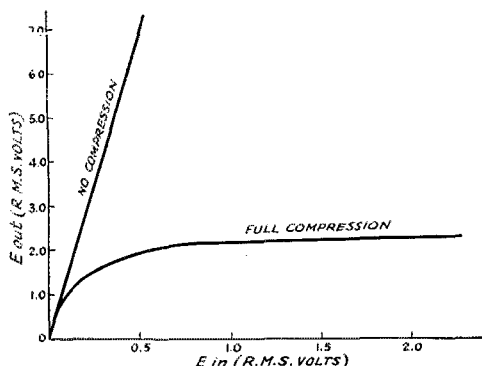

FIG. 3—CHARACTERISTIC OF AMPLIFIER WITHOUT COMPRESSION AND WITH FULL COMPRESSION

time of a quarter-cycle. If the grid bias can change appreciably during this time, distortion will occur. Substituting $t = 0.0025$ in the equation, we find that $\frac{e_2}{E_0} = .99$

Thus the bias change at 100 c.p.s. is approximately 1 per cent, which is negligible. At higher frequencies the variation is, of course, much smaller.

The whole assembly is mounted on a 7- by 9-inch chassis, and if power is to be obtained from the main amplifier, an even smaller space will be required. No special precautions other than the ordinary need be taken in the construction. All leads at high a.c. potential with respect to ground must be well shielded, and shield caps should be placed on the 6J7 and the 6L7 to avoid hum pick-up.

There are several advantages to this type of compression. The amount of compression is continuously variable from zero to maximum by

means of a single control. The voltage required to operate the device correctly is about one or two volts signal input, which may be obtained from the output of the pre-amplifier of a crystal mike, condenser mike, or directly from a single-button mike through its transformer. Most of our tests were made by feeding a magnetic pick-up directly into the input of the compressor. It is possible to increase the *average* level, for music, about 10 db., which should at least double the percentage modulation. This doubling of the percentage modulation is practically as effective as increasing the carrier power four times. Another advantage is the prevention of overmodulation from sudden bursts of sound. These two features alone make the compressor worth while to every 'phone man.

Central Division Convention

Detroit, Mich., September 4th, 5th, 6th

WITH the mammoth program arranged to insure every one a wonderful visit, excellent speakers, fine entertainment and prizes galore, the convention committee of the Greater Detroit Amateur Radio Council has obtained special hotel rates as low as \$2.00 per day, for the convention to be held at the Hotel Tuller, Detroit, Mich., Sept. 4th-5th-6th. The Ladies Entertainment Committee has prepared a special program with many valuable prizes, tours, etc. The convention begins Saturday morning; the big Jamboree, with free refreshments, Saturday evening and the gala banquet Sunday evening. The registration fee for the entire convention, including the banquet is only \$3.00 per person.

See your local railroads and bus companies regarding special rates on purchases of tickets in groups, as some very substantial reductions in the regular rates may be obtained in this manner.

Mail advance registrations direct to the Hotel Tuller to insure choice reservations.

Midwest Division Convention

October 9th and 10th, at Kansas City, Mo.

THE advance ticket sales indicate a wide interest in the Midwest Convention to be held in Kansas City, Mo., October 9th and 10th. Present indications are that this convention will take on the status of a national meeting. A program replete with interesting events for the "Hams" and "Hamesses" has been prepared and the different committees will be ready to take you in tow the moment you arrive at the big 6½ million dollar Municipal Auditorium. Tickets purchased in advance entitle the holder to chances on special valuable prizes. Orders for tickets should be sent to D. H. Cameron, R.F.D. 4, Kansas City, Kansas, enclosing check or money order in the amount of \$2.50 for each ticket.

● ARMY-AMATEUR RADIO SYSTEM ACTIVITIES ●

THE 1937 A.A.R.S. SEASON

THE new operating season of the A.A.R.S. starts the first Monday in September. Last year the season was opened with a "ZCB/QSO" Birthday Party on Monday, September 6th, which was also a holiday. This year we will not open the season with a contest, since many A.A.R.S. members will be enjoying a last-minute vacation on Labor Day.

During last season we instituted the system of eliminating, wherever possible, all nets below the state net, and of having all stations operate on a "spot state-net frequency." It is hoped that more members will be able to obtain crystals for their state-net frequency.

Having all stations in a state able to operate on the same frequency is another step forward in establishing more efficient service in time of emergency. Too many small nets make it difficult to contact the proper stations and slow up messages by the necessity for many relays.

The use of break-in speeds up the transmission of messages in spot-frequency nets. It also is a factor in reducing the amount of interference. Your own signal can be used to locate the "spot" on your receiver and long calls are not necessary. An operator should never call a station more than three times without signing his own call. Normally this is sufficient to raise a station if the crystal is near enough to the proper frequency.

And speaking of break-in, the following is an extract from a letter which appeared in the *Ninth Corps Area A.A.R.S. Bulletin*:

epi bud hendericks
signal corpse area
california
honorable corporal sir

excuse ples, one day my frend i work on from ham stashun
tell me join up army armatur radio sistem so i join up* next
day he ask break in from me.

so "oh excuse ples" i interrogate. "break out of jail i
understand very well. break in i not have comprehending of.
please i ask for illucidating"* he explaining "leave on receiv-
ing all time while send code out" so i try* but ouch inside of
ears resembling nerve of tooth being lifted* how many dots
i make from honorable bug is confusing—one dash make
resemble to 2 dots then i make all dots for mistake and make
attempting some more* same occourences and ringing of bells
in drum of ear now so i have pull out switches in searching of
enlshighting from qst still in wrapping. i open—first 8&7
part from mill of respectful editor i find much describing of
ham stashuns. but with break in missing i think so—* so i
writing signal corpse area i ask to know ples. "how do you
birds send with that tape-like precision and work break-in?"

ToGo HOROSHIMA

1936-7 A.A.R.S. Season

The following are a few extracts from the annual report to the Chief Signal Officer on the activities of the A.A.R.S. during the period July 1, 1936, to June 30, 1937:

TRAFFIC

Total messages handled by WLM-W3CXL (counting originated 1, delivered 1, relayed 1) were 22,458.

Total messages handled by the entire Army-Amateur Radio System, 504,330.

TRAINING ACTIVITIES

1. *Speed Contest-Competition of Accuracy and Speed.* Clear text broadcast by WLM-W3CXL on the frequencies 6990 and 3497.5 kc. at speeds from 20 to 60 w.p.m. High individual copied 60 w.p.m. Non-members were invited to participate.

2. *Training in Cryptanalysis.* Code and cipher messages in unknown key were broadcast by WLM-W3CXL. Those successful in breaking them down reported by radio to WLM.

3. *Intercept Problems.* Certain stations were picked out by WLM to broadcast a message. The location of the station and the frequency were

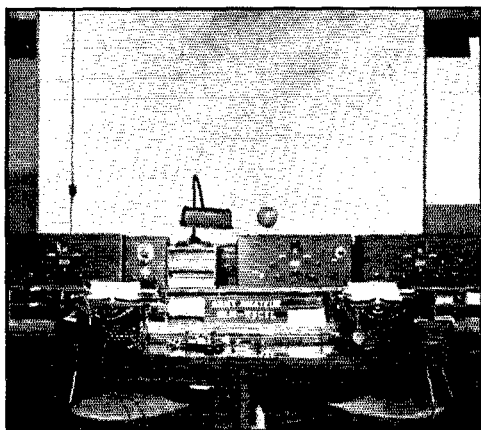

OPERATING POSITION AT WLM/W3CXL—AS BUSINESS-LIKE AS THE MANY OTHER OPERATING POSTS IN THE EFFICIENT ARMY MESSAGE CENTER, MUNITIONS BUILDING, WASHINGTON

unknown to those trying to intercept the messages. Corps Area nets organized their stations to listen on certain blocks of frequencies in order to pick up the message.

4. *Weekly ZCVA.* WLM broadcast each Monday night at 7 and 10:00 P.M., on the frequencies 6990 and 3497.5 kc. simultaneously, a message of interest to all Army Amateurs and Corps Area Signals. (During the summer WLM-W3CXL or WLMC-W3DQN has been broadcasting also in the 20-meter band at 7:00 P.M., for the benefit of Panama, Hawaii and west coast stations.)

5. *Armistice Day Message.* The eighth annual Armistice Day message to all Army Amateurs

(Continued on page 105)

A Multi-Use Meter for the Amateur Station

Wide Range D.C. Readings Plus Comparative Checks on Field Strength or A.C.

By Herbert W. Gordon,* W1IBY

DEDICATED to the amateur who wonders but finds not, the little gadget pictured herewith serves a variety of useful purposes about the ham shack. Not intended as a precision instrument, nevertheless by its aid it is possible to perform most of the measurements amateurs find necessary in the operation and servicing of transmitters and receivers. It is compact, entirely self-contained, and batteryless. Essentially a multi-range meter combined with a tube voltmeter, it can be used in a variety of ways: as a continuity checker (or ohmmeter, with suitable calibration); as a d.c. voltmeter with

for field strength checking, or through a condenser to an a.c. circuit whose voltage it may be desired to check. Sufficient cathode bias is used on the pentode section so that the plate current is low (we arbitrarily use 0.4 ma. for this reference value) when no external voltage is applied to the grid. The operation of the tube is similar to that of a plate detector; that is, the plate current rises with signal. The plate current is set to the idling value by means of the grounded tap on R_4 , the voltage divider. This resistor is a 50-watt unit, not because it is necessary to dissipate anything like that amount of power, but simply because its size makes it possible to shift taps easily.

Heater voltage for the 12A7 is obtained from the 110-volt line through a line cord of suitable resistance. The 110 is applied directly to the rectifier plate and filtered by means of C_7 , C_8 and a 15,000 ohm resistor, R_3 . The resistor replaces the choke normally used for this purpose and is satisfactory because of the small current drain.

The small-size 0-1 d.c. milliammeter is connected to a d.p.d.t. switch so that it may be used either in the plate circuit of the 12A7 pentode or

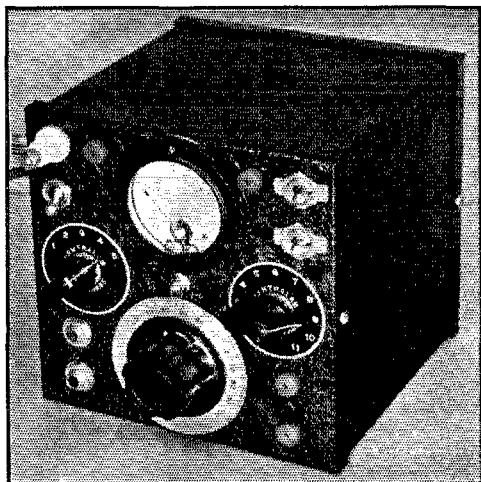

A PANEL VIEW OF THE COMBINATION MULTI-RANGE D.C. VOLTMMETER AND V.T. VOLTMMETER

This instrument has many uses about the amateur station. The only expensive item is the 0-1 d.c. milliammeter.

ranges from 3 to 1000 volts; as a d.c. milliammeter with ranges from 1 to 500 milliamperes; as a vacuum-tube voltmeter, when calibrated; or as an output meter or field-strength meter for comparative purposes without calibration.

The heart of the device is a 12A7 tube, which is a combination 30-ma. half-wave rectifier and an audio pentode. The pentode section is used as a v.t. voltmeter, while the rectifier furnishes the necessary d.c. for its plate. The complete circuit diagram is given in Fig. 1. The grid of the 12A7 may be coupled either to a tuned pick-up circuit,

* 77 Oxford Street, Hartford, Conn.

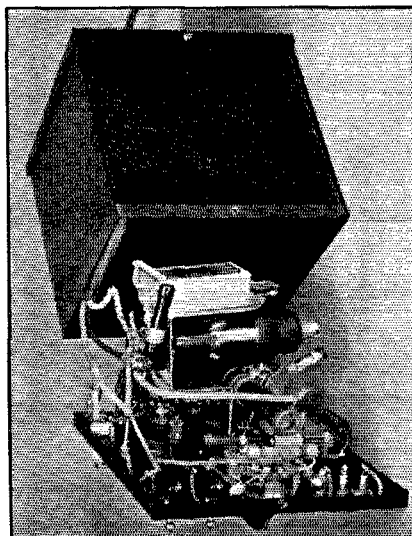

INSIDE THE MULTI-METER

Everything is supported from the panel. The 12A7 tube is mounted upside down from a sheet-metal platform. Power for operation is taken from the 110-volt line.

completely disconnected from it for external d.c. voltage and current measurements. The multi-meter circuits are conventional, using ordinary 1-watt carbon resistors as multipliers for the voltmeter readings and home-made shunts for current readings. The carbon resistors are entirely satisfactory unless a high degree of accuracy is desired, in which case precision multipliers should be used. For ordinary purposes, it is sufficient to pick out resistors which check closely on an accurate ohmmeter. The usual commercial tolerance of 10% gives quite a deviation, so if possible pick them out yourself.

The shunts specified in the table may be made by anyone without resorting to comparative checking. It is necessary, of course, to use a Type 506 Weston 0.1 meter or else one having the same internal resistance, if the same shunts are to be used. Nichrome wire could be used for the shunts, but copper is more convenient for all except the 10-milli-ampere range.

The uses of a multi-range d.c. milliammeter-voltmeter are obvious, so need no further comment. Connections for either are made through pin-jacks mounted on the panel of the device. A switch, *Sw*₃, is provided for disconnecting the shunts when the meter is being used for measuring voltages.

For checking continuity, a pair of test prods may be connected to the terminals marked "Ohms". Voltage for this purpose is obtained from a tap on the voltage divider, *R*₄, adjusting the tap until full-scale reading is obtained with the "Ohms" terminals shorted. *Sw*₂ must be open when the meter is so used.

In using the tube section as a voltmeter, care must be taken to keep the signal level low enough so that the milliammeter will not be driven off scale. In using the device as an output meter for checking receiver alignment, a shielded cable may be plugged in *J*₁, which automatically disconnects the tuned circuit *LC*₂. The cable shield should connect to the plug sleeve so that it is grounded to the case. The wire and shield may

then be connected across the voice coil of the speaker, or across the headset, if one is used. Using a modulated signal for aligning purposes, the needle of the meter will rise as the output is increased. The receiver's audio volume control may be used to keep the needle on scale.

For field-strength measurements, a short pick-up antenna should be connected to the antenna post

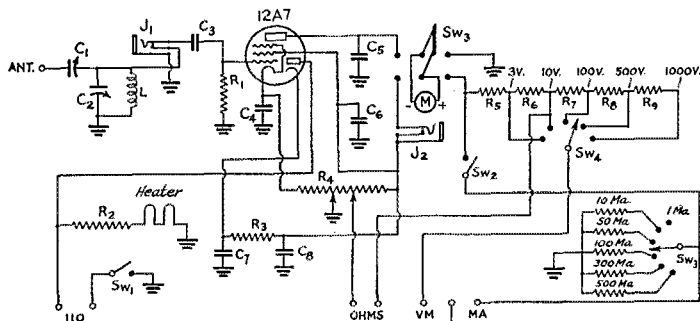

FIG. 1—CIRCUIT DIAGRAM OF THE COMBINATION METER

- | | | |
|--|---|--|
| <i>L</i> —9 turns No. 14, diameter $\frac{3}{4}$ inch, self-supporting. | <i>R</i> ₁ —1-megohm, $\frac{1}{2}$ watt. | <i>R</i> ₉ —500,000-ohm, 1-watt. |
| <i>C</i> ₁ —50- μ fd. trimmer. | <i>R</i> ₂ —390-ohm line cord. | <i>J</i> ₁ , <i>J</i> ₂ —Closed-circuit jack. |
| <i>C</i> ₂ —25- μ fd. midget. | <i>R</i> ₃ —15,000 ohms, 10-watt. | <i>Sw</i> ₁ , <i>Sw</i> ₃ —S. p. s.t. toggle switch. |
| <i>C</i> ₃ —0.1- μ d., 200-volt paper. | <i>R</i> ₄ —50,000-ohm, 50-watt semi-variable (slider type). | <i>Sw</i> ₂ —D. p. d.t. toggle switch. |
| <i>C</i> ₄ , <i>C</i> ₅ —250- μ fd. mica. | <i>R</i> ₅ —3000-ohm, 1-watt. | <i>Sw</i> ₄ , <i>Sw</i> ₅ —Multi-point switches. |
| <i>C</i> ₆ —0.1- μ d., 200-volt paper. | <i>R</i> ₆ —7000-ohm, 1-watt. | <i>M</i> —0.1 ma. d.c. milliammeter (Weston Model 506). |
| <i>C</i> ₇ , <i>C</i> ₈ —Double 4- μ fd. electrolytic. | <i>R</i> ₇ —90,000-ohm, 1-watt. | |
| | <i>R</i> ₈ —400,000-ohm, 1-watt. | |

and the tuned circuit *LC*₂ adjusted to give the highest reading on the meter, indicating resonance. When the meter is placed some distance away from the transmitter so that the pick-up is practically all from the transmitting antenna and not directly from the transmitter itself, changes in transmitter adjustments can readily be checked for effectiveness. If the coupling is adjusted to make the meter read around half scale, a pair of headphones may be plugged into *J*₂ for monitoring. The constants given in Fig. 1 for *LC*₂ are for 56-Mc. work, since this is the band in which the writer is chiefly interested. Of course suitable constants for other bands can readily be substituted. With a set of coils to cover a wide range of frequencies, the device could be used as a resonance-type frequency meter of fair accuracy.

So far as construction is concerned, no rules need be followed except to keep the leads in the r.f. circuit short and isolated from other wiring as much as possible. The remainder of the parts and wiring may be placed wherever convenient. As the photographs show, everything is supported from the panel of a small metal box, with a sheet-metal "platform" for the tube.

One precaution—as the diagram shows, the metal box serves as a "ground" for everything,

(Continued on page 94)

TABLE I

Shunt for	Wire	Length
10 ma.	No. 32 d.s.c.	209 inches
50 ma.	"	41 $\frac{1}{2}$ inches
100 ma.	"	20 $\frac{1}{2}$ inches
200 ma.	"	9 $\frac{3}{4}$ inches
500 ma.	"	3 $\frac{3}{4}$ inches

An A.V.C.-Controlled Pre-Amplifier

Output-Limiting Unit With High Gain and Flat Frequency Response

By James Hanson,* W2IGL

TO PREVENT tube overloading and consequent distortion in an audio amplifier, and likewise to prevent overmodulation in a 'phone transmitter, it is desirable that some automatic means be used for limiting the amplitude of the output of the audio system. To a considerable extent this ideal can be realized by applying the principles of automatic volume

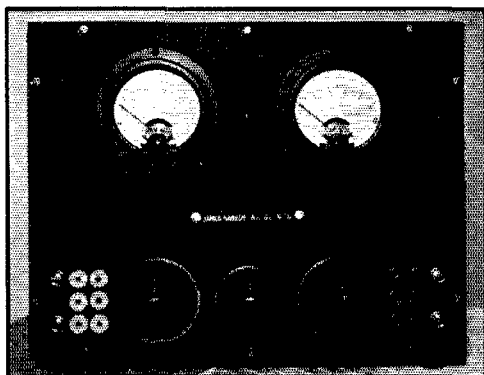

PANEL VIEW OF THE A.V.C.-CONTROLLED PRE-AMPLIFIER

The output is practically constant at the predetermined level with a wide range of input voltages.

control to the a.f. amplifier, preferably in the low-level stages.

The amplifier shown in the accompanying photographs will give substantially uniform output at zero level (6 milliwatts) with inputs from microphones ranging from -70 db to -15 db, by the combined action of the manual gain controls and the a.v.c. circuit. Separate input circuits are provided for high- and low-level inputs. With the appropriate manual gain control properly set to give zero-level output under average conditions with the particular microphone or phono pickup used, the input level may be increased 100 per cent—for example, from -70 to -35 db—without overloading and with but a negligible change in output. Practically, therefore, it is impossible to increase the output above the predetermined level, in this case zero db. The advantages of such a system are obvious.

Fig. 1 gives the complete circuit diagram of the amplifier and its power supply. The first stage, a 6J7 pentode-connected, is used for low-level inputs—a crystal microphone, for example.

*402 Concord Ave., Bronx, N. Y. C.

The 6J7's plate is coupled through condenser C to one high-impedance winding (the upper winding in Fig. 1) of a double input transformer, T_1 , and thence to the grid of the a.v.c. amplifier, a 6C5. A second high-impedance winding is coupled into the grid of the second speech-amplifier stage, also a 6C5. When a high-level microphone or pickup is used, this tube is the first speech amplifier, the input being through the primary or T_1 , which is provided with suitable taps for matching the electro-acoustic device. This tube in turn excites the output tube, another 6C5, through the interstage audio transformer T_3 . The output transformer, T_4 , couples into a line.

In the a.v.c. circuit, the output of the 6C5 amplifier is fed to a 6H6 full-wave rectifier through a dual-secondary transformer, T_2 . The rectified audio current flows through the potentiometer, R_9 , connected between the transformer center-tap and ground, thereby developing a d.c. voltage across R_9 which can be used to bias the two 6C5's in the speech amplifier. The amount of additional bias applied to the grids can be controlled by the setting of the potentiometer arm, and obviously depends as well on the amplitude of the signal fed to the rectifier from the a.v.c. amplifier. As the input signal is increased, the a.v.c. bias voltage also increases, causing a reduction in amplifier gain and holding the amplifier output substantially constant.

In operating the amplifier, the gain control should be set so that the average output is slightly

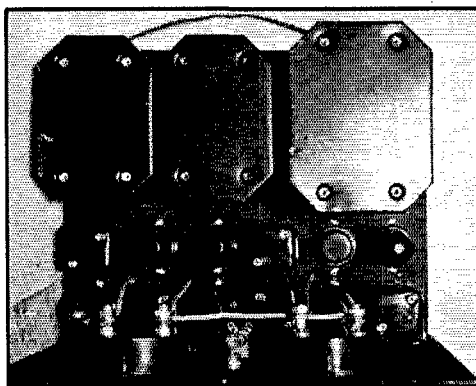

INSIDE VIEW OF THE PRE-AMPLIFIER

Power supply equipment is across the back. The amplifier and a.v.c. circuit alone can be built into a very compact unit, if desired.

less than zero db. This practice allows for sudden overloads and also eliminates any "flat-top" response which would occur if the amplifier operated at full zero level on the average signal without any reserve power for highs or overloads. Fig. 2 shows the relation between output and input, curve A being obtained with low-output microphones and with the 6J7 in circuit, and curve B with higher-output microphones working directly into the first 6C5.

Measurement has shown that the frequency response is uniform within 2 db from about 30 cycles to 15,000 cycles. On oscillographic tests, it was found that the wave-form was pure, indicating no distortion, when the input was increased approximately 100 per cent over the normal operating level of the amplifier, the over-excitation being suppressed by the a.v.c. without any change in wave-shape. Also, there is no detectable sluggishness in the response.

Referring to Fig. 1, condenser C_0 is used to stabilize the a.v.c. voltage impulses. Without this condenser there is a kink in the negative swing of the output signal, and it is important that it be included in the circuit.

Two views of the practical amplifier are given in the photographs. The cabinet housing the equipment is 12 by 9 by 9 inches, this size being necessary to contain the power supply as well as the amplifier proper. The latter can readily be built into a much smaller space (about 18 square inches) if powered from a separate source, and

may of course be included with another amplifier working at higher output level. The noise level is about 85 db below the operating level—a result which can be accomplished only by using shielding on every grid and plate circuit in the speech stages, and also by shielding the transformer

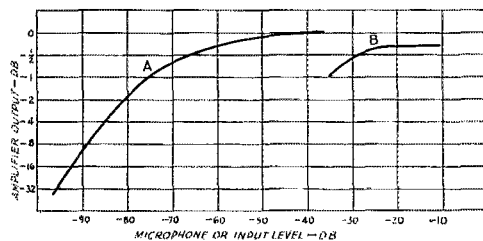

FIG. 2—OUTPUT WITH VARYING INPUT LEVELS
Curve A taken with low-output microphones such as the crystal or dynamic; Curve B represents a high-output device such as a phono pickup or carbon microphone.

terminals. Condensers and resistors must be of reliable make, and condensers in particular must have very high resistance and good power factor.

The pin jacks on the panel are the input and output terminals. All transformer taps are brought out to the panel to simplify impedance matching. The milliammeters check the plate current to the speech stages. One might also be provided for measuring the rectified current in the a.v.c. circuit. In operation, the plate cur-

(Continued on page 96)

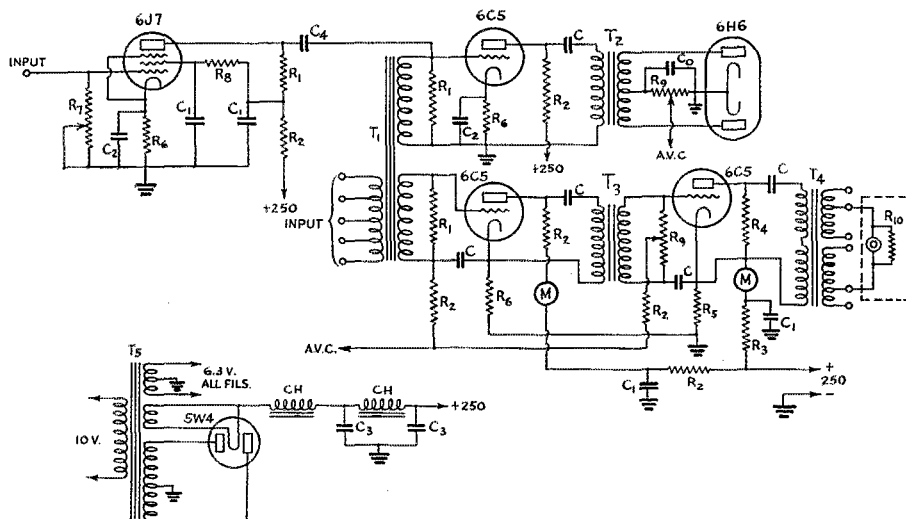

FIG. 1—A.V.C.-CONTROLLED PRE-AMPLIFIER CIRCUIT

- | | | |
|--|------------------------------|--|
| C—0.25- μ fd. paper condenser, 400-volt (Atlas). | R ₂ —50,000 ohms. | R ₀ —250,000-ohm potentiometer. |
| C ₀ —0.001 μ fd. | R ₃ —10,000 ohms. | T ₁ —Multiple line or microphone transformer to two grids (U.T.C. A-12). |
| C ₁ —0.5- μ fd. paper, 400-volt (Atlas). | R ₄ —30,000 ohms. | T ₂ —Single plate to two-grids (U.T.C. A-18). |
| C ₂ —25- μ fd. electrolytic, 25-volt. | R ₅ —1250 ohms. | T ₃ —Interstage audio (U.T.C. A-16). |
| C ₃ —10- μ fd. electrolytic, 500-volt. | R ₆ —4000 ohms. | T ₄ —Single plate to multiple line (U.T.C. A-24). |
| C ₄ —0.01- μ fd. paper, 400-volt (Atlas). | R ₇ —3 megohms. | T ₅ —Power transformer, 300 v. each side c.t., with filament windings (U.T.C. PA-21). |
| R ₁ —250,000 ohms. | R ₈ —0.5 megohms. | CH—Filter choke, 12 henrys (U.T.C. PA-40). |

The 1937 VK-ZL Contest

By L. G. Petrie*

THE support and enthusiasm with which the past VK-ZL International DX Contests have been met from amateurs throughout the world has convinced both the Executive Committees of the Wireless Institute of Australia, and the New Zealand Association of Radio Transmitters (Inc.), that the contest is now a looked-for event. This year the contest is promoted by the New Zealand Association of Radio Transmitters (Inc.), with the coöperation and assistance of the Wireless Institute of Australia.

THE CONTEST RULES

1. The Contest Committee of the N.Z.A.R.T. (Inc.) will be the sole judges and their decision on any rules or interpretations of these rules will be binding in the event of any dispute.

2. The nature of the contest requires contacts between the world and VK-ZL.

3. There will be three sections to the contest: (a) Senior, (b) Junior, (c) Receiving.

4. The contest is open to all licensed transmitting and receiving stations in all parts of the world. Unlicensed, ship and expedition stations are not permitted to enter. Financial members only of the W.I.A. and the N.Z.A.R.T. (Inc.), at the time of the contest, will be eligible for awards in Australia and New Zealand.

5. The stations competing in the Senior Section of the contest may use up to the maximum power allowed by the national Radio Regulations. The stations competing in the Junior Section shall use up to a maximum power input to the last stage of the transmitter of 25 watts.

6. All Amateur Frequency Bands may be used.

7. No prior entry is required, but each contestant is to submit a log at the conclusion of the contest showing date, time (GT), band used, station worked, signal reports exchanged, and points claimed for the QSO. Signal reports must include strength, readability and tone.

NOTE.—No serial numbers are to be exchanged. Each log submitted is to be concluded showing the total points claimed computed as per Rule 9, together with a declaration as to the power input to the last stage of the transmitter. A contestant may enter for both Senior and Junior Sections and will submit a separate log for each Section.

8. The Senior Section will be held from 1200 GT, Saturday, October 2, 1937, to 1400 GT, Sunday, October 3, 1937 and will be continued between the same times on the following weekend, October 9th and 10th. The Junior Contest will

be run from 1200 GT Saturday, October 23rd to 1400 GT Sunday, October 24th, and will be concluded between the same times in the following weekend, October 30th and 31st.

9. Scoring for all sections: Twelve points will be scored for the first contact with a station in a country other than VK-ZL, 11 points for the second, 10 for the third and so on until the twelfth will score one point.

The first twelve contacts will score 78 points, and each additional contact after the twelfth will count one point. In all cases contacts are irrespective of the band used. This will apply to all countries except England and the United States of America; in these countries twelve or more (as above) contacts will be permitted with stations having the following prefixes: G2, G5, G6, Scotland and W1, 2, 3, 4, 5, 6, 7, 8, 9. The points scored by contacts in the above manner will be added together and multiplied by the number of countries worked which give the final score. Each W and G district will not constitute a separate multiplier.

10. Scoring by competitors beyond VK-ZL: Twelve points will be scored for the first contact with a VK-ZL prefix zone, 11 for the second, 10 for the third and so on to the twelfth contact, which will count one point. The first twelve contacts with a particular prefix zone will therefore score 78 points. Each additional contact after the twelfth will count one point. This will apply to each VK-ZL prefix zone worked. The points scored in the above manner will be added, and the total multiplied by the number of VK-ZL prefix zones worked, which will give the final.

The prefix zones are VK 2, 3, 4, 5, 6, 7, 8, 9, and ZL 1, 2, 3, 4.

11. Only one contact with a specific station on each of the bands will be permitted to count during the whole of the contest except on the 28-Mc. band, where one contact each weekend will be permitted to count.

12. Entries from VK stations must reach W.I.A., Box 2127L, G.P.O., Sydney, not later than December 1, 1937. All overseas logs must reach Contest Committee, N.Z.A.R.T. (Inc.), Box 489, Wellington, New Zealand, not later than December 31, 1937. All entries must reach the Contest Committee, N.Z.A.R.T. (Inc.), Box 489, Wellington, not later than December 1, 1937.

AWARDS

Attractive certificates will be awarded to the station returning the highest total in each country; to the highest scorer in each of the G and W prefix districts and Canadian Districts.

*General Secretary, N.Z.A.R.T., P. O. Box 489, Wellington, N. Z.

RECEIVING CONTEST

1. The general rules for the receiving contest are the same as for the transmitting contests and it is open for any short-wave listener in the world.

2. Only one operator is permitted and only one receiver can be used.

3. The dates, times, scoring of points, logging of stations, and bands used, for the duration of the contest are the same as for the transmitting contest.

NOTE.—Reception of 28-Mc. stations will be permitted to count once on a weekend, and not once only for the duration of the contest.

4. To score points the call sign of the station being called and the readability, strength and tone of the calling station must be entered in the log together with band, time, date. Logging of CQ on test calls will not count.

NOTE.—Overseas stations must be logged when calling either ZL or VK stations by Australian or New Zealand listeners. Overseas listening stations must log VK-ZL stations when they are calling overseas stations.

5. Australian and New Zealand stations will count their score as per Rule No. 9 of transmitting contests.

6. Overseas listening stations will count their score as per Rule 10 of the transmitting contests.

7. Entries must be sent as per Rule No. 12 of the transmitting contests.

Developments in High-Power U.H.F. Tubes

TRANSMITTING tubes are being trimmed down to fit small wavelengths. Maybe the

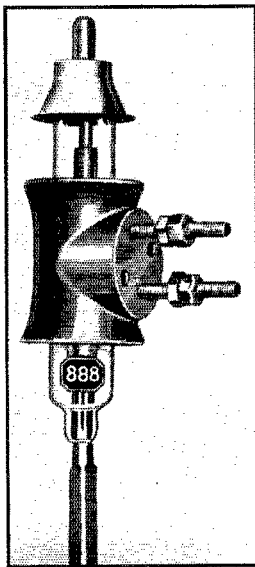

THE SEVEN-INCH 888

success of the acorn receiving tubes has something to do with it, maybe not, but the trend now seems to be to put a lot of tube in a small space in the interests of better performance at the ultra-high frequencies. In the belief that amateurs will be interested in knowing what's going on in the tube world, even though there may be no direct practical application, we present here some data on some new types, built especially for u.h.f. applications, which have some novel constructional features.

The gadget, which looks like a test tube pushed through a shaving mug, is a miniature water-cooled tube having a rated plate dissipation of one kilowatt. Its overall length is only seven inches. The water jacket is part of the tube structure. The "hat" at the top is a corona shield attached to the grid lead. Two types, alike in fundamental design, are made; one, with an amplification factor of 10, is designated the 887, and the other, with a μ of 30, the 888.

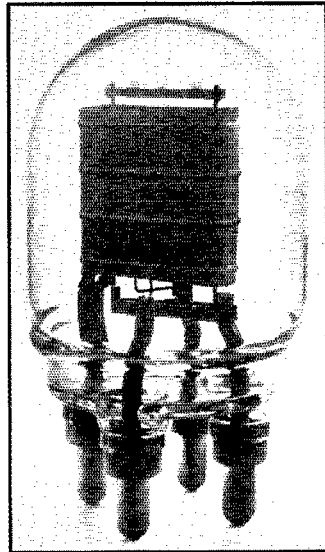

THE WL-461

As Class-C amplifiers these tubes can deliver an output of 800 watts at 300 megacycles. Maximum plate voltage is 3000, maximum plate current 400 milliamperes. The filaments, presumably tungsten, take 24 amperes at 11 volts. The small size of the tube and short, heavy leads keep both interelectrode capacities and lead inductance down.

The second photograph shows a new Westinghouse tube which also is approximately 7 inches long. Built especially for diathermy applications in the neighborhood of six meters, this tube, known as the WL-461, is more or less "standard" in element structure, but has no base. Short, heavy rods connect the tube elements to metal thimbles which form the output connections. The elements are closely spaced to reduce electron transit time, often a more important consideration at ultra-high frequencies than reduction of interelectrode capacities, where the latter are not so high that the tube becomes self-resonant near the operating range. The plate is made of tantalum.

The WL-461 is rated at a maximum d.c. plate voltage of 2000; rated plate current is 250 milliamperes. The tube has a 5-volt, 11.5-ampere filament. The amplification factor is 28. An output of 400 watts can be obtained at six meters.

A Compact Airplane-Type 'Phone Transmitter With Vibrator Power Supply

By R. M. Ellis,* W9YSA

AN airplane transmitter constructed by an Indianapolis radio amateur and aviation enthusiast, Leon Linn, W9LHF, has a number of features which are of unusual interest to radio amateurs, and is presented here because of the present interest in mobile and portable transmitting equipment. Weighing only 14 pounds complete with the self-contained power supply, this transmitter is capable of a full 10 watts of 100 per cent modulated output to the antenna.

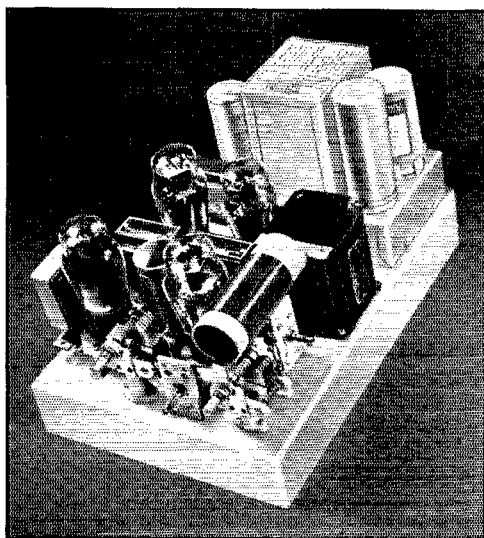

CONNECT THE ANTENNA, MICROPHONE AND STORAGE BATTERY AND IT'S READY TO GO

In front are the push-pull oscillator and neutralized amplifier stages, with the speech amplifier-modulator and vibrator power supply in the rear.

All parts of the transmitter are mounted on an aluminum chassis, 8 inches long, 12 inches wide, and 2 inches deep. Plate voltage for the transmitter is obtained from a "Vibrapak" which permits the operation of the transmitter directly from the storage battery without requiring the use of auxiliary apparatus.

The particular transmitter shown was equipped with a special 12-volt model "Vibrapak." The schematic diagram shows the hook-up for 6-volt operation, using a standard Mallory "Vibrapak"

VP552, and is given because most applications will be for use with a 6-volt storage battery. 12-volt operation simply calls for series-parallel connection of the filaments and the use of a special 12-volt "Vibrapak."

A happy feature of this design is that only two small compact parts will provide any necessary replacement that might be required after hours of use. There are only two things about this transmitter which are subject to wear—the tubes and the vibrator. Since 6A6 tubes are used in all four sockets of the transmitter, a single 6A6 tube and a single vibrator weighing but a few ounces can be carried in the glove box of an automobile or the map compartment of an airplane to provide a complete stock of spares.

In the original installation the transmitter was mounted on a spring suspension immediately behind the rear cockpit of the plane and adjacent to the storage battery. This is desirable since it assures maximum output from the "power supply" and also prevents hum which might occur from a.c. ripple in the filament circuit.

Remote operation is readily obtained by means of two relays located underneath the transmitter chassis. Relay 1 (Fig. 2) controls the filaments and is operated from a toggle switch on the instrument panel. Relay 2 energizes the power supply and is controlled by a switch on the microphone hand-set so that "push-to-talk" operation is made available.

The coil constants shown on the schematic diagram are for operation on the 3105-kc. airplane

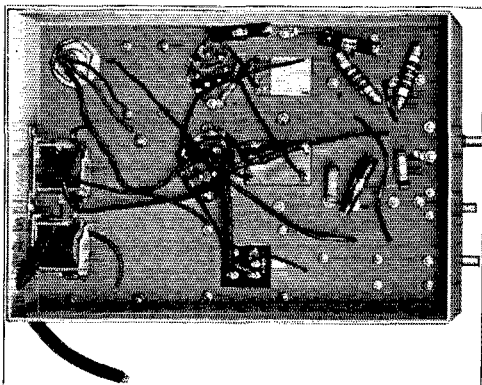

THE CONTROL RELAYS FOR REMOTE OPERATION ARE UNDERNEATH

* P. R. Mallory and Co., Inc., Indianapolis, Ind.

frequency. These same coils can be used on the 80-meter 'phone band, although a higher L/C ratio will be obtained than is customary, and the removal of a few turns of wire would probably be desirable. 160-meter 'phone operation is also

practical if the coils are designed so that the 100 $\mu\text{fd.}$ tuning condensers may be set for resonance near the point of maximum capacity.

Using a quarter-wave or Marconi antenna in an airplane, Chicago, Terre Haute, and St. Louis were worked with reports of good signal strength when flying at an altitude of 5000 feet above Indianapolis. The transmitter was given one ground station test on the 3.9-Mc. amateur 'phone band, using a half-wave Zepp antenna, and within a short period of time amateur 'phone stations in Newark, New Jersey; Nashville, Tennessee; and St. Louis, Missouri, were worked with signal strength reports of S7 to S9. Because it was desired to make a permanent mobile installation in the airplane, no further tests were made on the amateur bands.

Radio amateurs as a rule are rugged individualists and seldom make an exact copy of any receiver or transmitter. For that reason complete constructional details are more or less superfluous. If the usual common sense rules of transmitter construction are followed, thoroughly satisfactory results should be obtained through an infinite number of variations of W9LHF's original design.

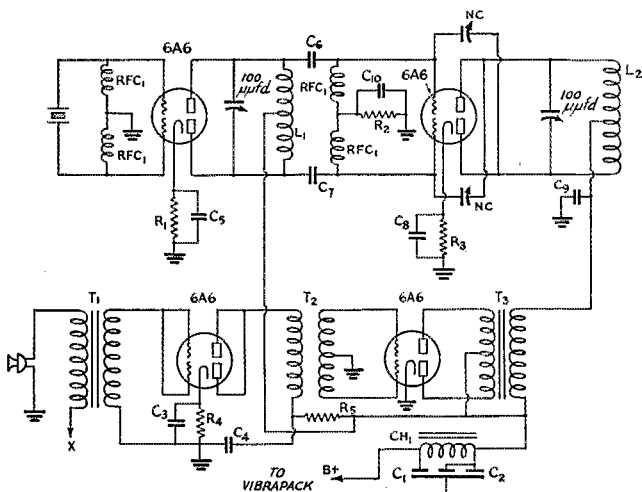

FIG. 1—CIRCUIT OF THE TRANSMITTER SECTION

- L_1, L_2 —44 turns No. 22 enamel wire on $1\frac{1}{4}$ " bakelite tube. (See text.)
 C_1, C_2 —8-8-8- $\mu\text{fd.}$ 450-volt electrolytic (Mallory RN245).
 C_3 —10- $\mu\text{fd.}$ 25-volt (Mallory TS101).
 C_4 —8- $\mu\text{fd.}$ 450-volt (Mallory CS133).
 C_5, C_8 —0.01- $\mu\text{fd.}$ 400-volt tubular paper (Mallory TP421).
 C_6, C_7, C_9 —0.001- $\mu\text{fd.}$ mica.
 C_{10} —0.01- $\mu\text{fd.}$ 2000-volt (Mallory OT461).
 R_1, R_3 —500-ohm 10-watt vitreous resistors (Electrad 1HJ 500).
 R_2 —10,000-ohm 10-watt vitreous resistor (Electrad 1HJ 10,000).
 R_4 —1200-ohm $1\frac{1}{2}$ -watt (Electrad type MG molded wire resistor).
 R_5 —1500-ohm $1\frac{1}{2}$ -watt (Electrad type MG molded wire resistor).
 T_1 —Single-button microphone to grid transformer.
 T_2 —6A6 Class-B input.
 T_3 —6A6 Class-B output to 5000-ohm load.
RFC—2.5-millihenry pie-wound r.f. chokes.
 CH_1 —15-henry 100-ma. choke.

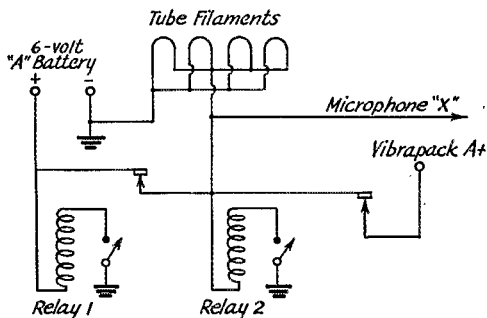

FIG. 2—DIAGRAM OF POWER SUPPLY CONNECTIONS

Relays 1 and 2 are Mallory No. 16754.

Hudson Division Convention

September 17th, 18th, 19th, at Asbury Park, N. J.

THE official headquarters for the Hudson Division Convention this year will be the Hotel Berkeley-Cartaret, at Asbury Park, N. J. The dates as mentioned in the caption are September 17th, 18th, 19th, Friday, Saturday and Sunday respectively. The Jersey Shore Amateur Radio Association, sponsoring this affair, extends a cordial invitation to all radio amateurs in the Hudson Division and surrounding areas. Meetings, lectures, informal entertainment such as Boardwalk strolling, Swimming, etc., have been planned. There will be no idle moment during the convention. The committee has arranged with the hotel people for reasonable rates for rooms over the week-end.

Registration Fee is \$3.50 if made in advance and will be accepted up to September 17th; otherwise the fee is \$4.00. Send your advanced registration to Oliver G. Tallman, Secretary, 155 Main Street, Manasquan, N. J.

The Canada-U. S. A. Contact Contest, 1937

By George Cooper, VE3ACI, and Fred H. B. Saxon,* VE3SG

THE fourth A.R.R.L. Canada-U. S. A. Contact Contest, held April 16th to 18th was a thoroughly enjoyable weekend of operating. In scoring, one point was allowed for each message preamble sent and one point for each one received, a maximum of two points for each QSO. This method, which originated in the SS contest is very popular for 'test work. Certificates, signed by the Canadian General Manager, as well as the committee chairman, have been forwarded to each of the section winners. The ten highest scoring Canadian and United States stations:

CANADA			
VE3GT.....	34,807	VE3AEM.....	19,003
VE3IR.....	23,665	VE5HP.....	17,640
VE3JT.....	22,172	VE3QD.....	16,810
VE5QP.....	20,376	VE5EH.....	15,312
VE4QZ.....	19,800	VE4ZC.....	15,114

UNITED STATES			
W6ITH.....	12,726	W3FQZ.....	10,395
W9TYF.....	12,474	W8BYM.....	10,300
W6MVK.....	12,285	W9EYH.....	10,017
W9CFB.....	11,813	W6VKF.....	10,017
W2IOP.....	10,584	W6HJT.....	9,072

VE3GT, last year's committee chairman, worked 238 W stations in 51 sections for a total of 34,807 points. His input was 46 watts and his total operating time was 40 hours and 20 minutes, which averages 6 QSO's per hour. He says, "No need for me to mention what I think of the contest. Ham radio wouldn't be ham radio without it." VE3IR worked 199 W's in 49 sections for 23,665 points. His input was 45 watts. W6ITH leads the United States contingent with 12,726 points, for 101 contacts in all seven Canadian sections. He used 1.9-, 3.9-, 7.0-, 14- and 28-megacycle bands. On one "CQ Canada" two Swedish hams went back to him, he worked them both, and then heard two VE's condemning him for it! "Old Eight Watt" W5CPT, was right in there again, 16 contacts—six sections, total 2873. W6BXL worked VE5LD, King William's Land, North West Territory, and asks if it is an eighth Canadian section. Sorry, OM, but the thrill you got from that contact will have to be your recompense this time. W2JJE won his club's prize of \$1.50 in the contest as well as placing first in the Northern New Jersey section. W8ONK hooked his seventh VE section just seven minutes before the contest closed. Logs were received from two Canadian YL ops. W6OFD and 6MVK (both named Chow) are located in San Joaquin Valley section but OFD

operated "portable" in Sacramento Valley section. Yes—they both get certificates.

Numerous comments were made on the courteousness of the VE hams. I think you have something there, fellows, don't lose it. W6CMU hopes to get cards from all his VE QSO's. W9MUX is sorry he did not use low power. Had he done that he might have been on top. W9HQH (OO, Illinois), "Surprised to hear such a high percentage of good notes, but did send out several service messages in place of OO cards." W3FSP—"The VE/W test combines the best features of the SS and DX tests." W9EUZ worked his first VE1 after nine years of trying. Twelve VE's worked K6.

W9TYF, W9DMY, W1BFT, W1BBN, W6MVK, VE4GE, and VE4QZ won in their sections for the second consecutive time. W9FOQ won in his section for the third consecutive time.

VE/W Contest Scores

	Points	QSO's	Sections
MARITIME			
VE1EX	5858	34	36
1CD	4698	55	29
1BF	3	2	1
ONTARIO			
VE3GT	34807	238	51
3IR	28665	199	49
3JT	22172	188	46
3AEM	19003	158	41
3QD	16810	205	41
3ER	13815	158	45
3AAG	13620	133	41
3AJE	11934	109	39
3ZE	10500	101	37
3OI	9694	131	37
3EM	9502	91	35
3CG	8860	100	30
3HP	7533	137	31
3DU	6615	75	30
3TO	5655	69	29
3KF	5652	81	36
3AE	5580	82	24
3ALX	5400	75	24
3AJB	3834	77	27
3XL	3790	67	19
3NA	2679	62	13
3DJ	2160	45	24
3AIT	1479	30	17
3DH	1240	32	20
3TM	735	25	15
3SS	512	16	11
3AKX	128	8	8
3ACJ	117	7	6
3UP	105	7	5
QUEBEC			
VE2LU	13072	126	35
2DR	6724	32	41
2LC	4888	95	26
2MV	4105	62	23
2AA	3105	76	23

* Chairman, VE/W Contact Contest Committee.

	Points	QSO's	Sections		Points	QSO's	Sections
2FF	2002	37	23	INDIANA			
2JT	1608	34	16	W9TYF	12474	66	7
2HI	495	15	11	9CNG	108	4	1
2JZ	312	13	8				
ALBERTA				KENTUCKY			
VE4GE	10352	150	44	W9SDG	27	1	1
4AFT	3906	50	28	MICHIGAN			
4EO	2295	44	27	W8ONK	8694	46	7
4ABH	2173	36	21	8NUV	2322	21	4
4VJ	2079	36	22	8AFK	90	5	1
4ADW	168	9	7				
BRITISH COLUMBIA				OHIO			
VE5QP	20376	155	48	W8BYM	10300	54	7
5HP	17460	194	45	8PQK	198	11	6
5EH	15312	169	48	8OPT	54	2	1
5FG	12600	107	42	8LCO	3	1	1
5QA	10947	100	41	WISCONSIN			
5KQ	6039	61	33	W9EYH	10017	53	7
5PW	5265	74	30	9WSY	1890	14	5
58W	2002	46	15	9GWK	1368	19	4
5RK	1730	35	19	9YCV	648	6	4
5JH	1425	40	19	9ZFT	202	8	1
5RE	84	7	4	9TJI	81	3	1
5RI	12	2	2				
MANITOBA				SOUTH DAKOTA			
VE4YO	2241	45	27	W9FOQ	1539	19	3
4TZ	1827	30	21	9VOD	1282	10	5
				9YEZ	1215	15	3
SASKATCHEWAN				NORTHERN MINNESOTA			
VE4QZ	19800	151	44	W9YCR	6615	35	7
4ZC	15114	120	44	9RTN	2376	22	6
4ABR	3	1	1	9DNY	1512	14	4
				9TIV	1188	11	4
EASTERN PENNSYLVANIA				9WZA	360	6	4
W3CHH	6480	60	6				
3BFL	2754	27	6	SOUTHERN MINNESOTA			
3FXZ	810	15	2	W9VKF	10017	53	7
3DGM	702	13	2	9VIP	2673	17	6
3BGD	576	8	4	9KUI	108	3	2
3ANE	243	6	3	9YNQ	9	1	1
MARYLAND-DELAWARE-DISTRICT OF COLUMBIA				LOUISIANA			
W3FQZ	10395	55	7	W5KC	162	3	3
3FPQ	5508	51	6	MISSISSIPPI			
3FSP	4473	36	7	W5GHF	1620	16	4
				5FIT	135	3	2
SOUTHERN NEW JERSEY				5GEA	27	1	1
W3FAX	5103	42	7	EASTERN NEW YORK			
3GRM	2790	31	5	W2DIJ	6426	51	7
3ECG	486	9	2	2DDV	3726	23	6
WESTERN NEW YORK				2ISQ	810	15	2
W8PWU	8694	47	7	2KFT	648	12	2
8JTT	2484	25	4				
8QHX	828	23	2	N. Y. C. AND L. I.			
8DHU	648	18	2	W2IOP	10584	56	7
				2HYA	6642	41	6
WESTERN PENNSYLVANIA				2HDT	3024	28	6
W8NTJ	5602	44	5	2HMJ	2880	40	4
8OFO	2700	26	6	2EYS	1404	26	3
8MIH	1242	23	2	2HUG	540	10	2
				2DMN	360	5	4
ILLINOIS				2KFM	135	5	2
W9MUX	8631	68	7	2HBO	64	2	1
9EUZ	3780	21	7	NORTHERN NEW JERSEY			
9WEN	1566	15	4	W2JJE	5197	27	7
9TMU	1386	11	7	2HXI	5166	41	5
9HQH	990	11	5	2JKH	3465	40	5
9CEO	648	12	3				
9GMT	216	8	1				

(Continued on page 108)

HINTS and KINKS for the Experimenter



6E5 Crystal Oscillator and Meter Substitute

By A. R. Richards, W8NFM

WHILE designing a portable transmitter it was discovered that the 6E5 would function as a crystal oscillator and at the same time act as an indicator of r.f. resonance. The final transmitter, consisting of a 6E5-802 r.f. line-up with suppressor grid modulation, proved to be an excellent one. Naturally in such a stand-by outfit, simplicity and ruggedness are paramount, hence the elimination of the crystal plate milliammeter is quite an item.

Referring to the circuit in Fig. 1, when L and C are not in resonance with the crystal the fluorescent disc of the tube shows a triangle formed by overlapping of the edges. This segment is a brighter green than the rest instead of showing the customary shadow. When L and C resonate with the crystal the triangle becomes twice as large and has the appearance of being "misty."

This circuit will oscillate if the crystal is removed. This condition will be obtained only if there is no coupling between the plate coil and the r.f. choke. This choke should be made by removing turns from the secondary of an ordinary b.c. transformer until the fundamental of the coil is in the neighborhood of 1700 kc. if the low-frequency band is used, and to corresponding proportions for the other bands. Under these circumstances, with the crystal plugged in, the circuit functions as a locked oscillator with the very desirable property of staying in step with the crystal through ten or fifteen degrees of dial rotation. Crystal locking is easily observed, since the shadow is definitely larger when the crystal takes control of frequency.

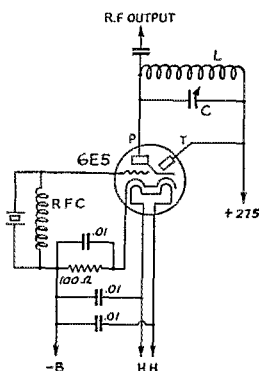

FIG. 1—6E5 CRYSTAL OSCILLATOR, USING THE CATHODE RAY SECTION AS A RESONANCE INDICATOR

L and C are the ordinary resonant circuit capable of tuning to the crystal frequency. The "r.f. choke" is actually a t.n.t. type coil to give regeneration and self-oscillation; the circuit is that of a locked oscillator.

In the design of an outfit likely to be used for emergency service, this locked crystal circuit has several advantages over a straight crystal circuit; the transmitter will never be without excitation even though not on crystal frequency, and QSY to dodge QRM is also possible.

Good output can be secured on the crystal frequency without utilizing the locking system by coupling the grid choke to the plate coil (with the crystal out of the circuit) inversely or in the degenerative direction. Use just enough coupling to kill self-oscillation throughout dial rotation. Then when the crystal is plugged in, the output will be only on crystal frequency and of surprising strength.

A fortunate feature of this circuit is that nothing is critical about the whole set-up; the output is so stable that the plate terminal may be touched with the finger without stopping oscillation. The adjustment of the degeneration coil likewise is not critical; it is not the hair-breadth setting that the old style regenerative receivers required. While the "magic eye" pattern shows the characteristic crystal dip, the dial setting is several degrees broader than with a conventional pentode oscillator. The output, measured roughly with light bulb loading and also by exciting a transmitter, compares favorably with a 41 used here at the same plate voltage.

This circuit worked so beautifully right from the start that no particular pains were taken to develop its possibilities to the fullest extent. A little experiment may bring out other advantageous features. One thing that was done was to attempt to use it in the conventional circuit using a resistor in series with the grid choke. This resulted in very low output, regardless of the value of the resistor. This use of the 6E5 does not result in shortened life, apparently, since the circuit has been used as an exciter in a transmitter here for a period of two months with no indication of tube weakening. No attempt was made to use the tube with more than 275 volts; a little experiment here may or may not be worth while.

Regenerative Audio Amplifier for C.W. Selectivity

THE circuit of Fig. 2 is effectively an audio oscillator with loud speaker volume. Omit R_1 , T_1 and C_1 , which form the input from the receiver, and the audio oscillator is left. In the

audio oscillator circuit, C_2 is the variable condenser which controls the tone of the audio note, and R_2 is a variable volume control which acts as a sensitivity control.

In operation this control is advanced until audio oscillation is obtained. If no sound is heard, reverse the connections of T_2 on the secondary side. After sound is obtained, C_2 is adjusted to

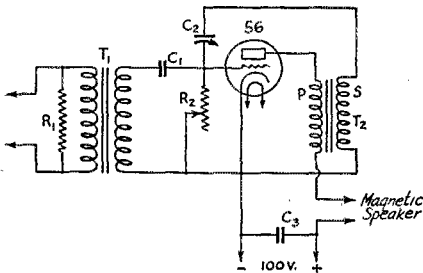

FIG. 2—REGENERATIVE AUDIO AMPLIFIER FOR C.W. SELECTIVITY

- R_1 —100,000 ohms.
- R_2 —100,000-ohm volume control.
- C_1 —250- μ fd.
- C_2 —100- μ fd. variable.
- C_3 —1 μ fd.
- T_1 —Audio transformer (ratio 1:1).
- T_2 —Audio transformer (ratio 3:1).

give a desirable pitch, and R_2 is then backed off until audio oscillation just ceases. Any input through T_1 of the same pitch or tone as that to which audio oscillator has been adjusted will cause an audio output of far greater amplitude than the exciting signal, and although other tone frequencies will be heard through the loud speaker, there is an enormous increase in volume when the receiver is adjusted to give the exact pitch to which the audio oscillator is tuned. Unwanted signals of equal or greater strength but of slight difference in tone pitch practically disappear, while atmospheric and other forms of static are also down.

R_1 is a one-watt carbon resistor for howl suppression. As built, this unit has its own power supply and is separate from the receiver, being connected to the receiver at the headphone jack. It can be used with any receiver that will give c.w. signals. Care must be used in the initial adjustment; after that all that is necessary is to turn the receiver dial. Tuning on the receiver should be slow since the tone peak can be passed very quickly. In some cases the band can first be

searched for a call and the audio selector then plugged in.

—Chas. E. Diehl, W6EVF

Antenna-Coupling System

FIG. 3 shows circuits for an antenna coupling scheme we have been using for the last six months or so, and which beats anything else we have tried. It is particularly adapted to portable and emergency work, as it will couple almost anything to any piece of wire and make it do a good job of radiation. We have used an antenna as short as 30 feet with this system and made it tune to 160 meters. In fact, we operated for two months using a 30-foot indoor antenna and this coupling system and during that time were able to work 160-meter 'phones 75 miles away, in daylight, with 15 watts input. At other times we have hooked up to whatever BCL antenna happened to be available, and it has never yet failed to tune up in just a few minutes.

The system is not new, but will probably be new to a good many of the ham fraternity who are not familiar with the circuits of some of the older broadcast transmitters. According to the length of the antenna, it operates either as an L -section filter or as a simple series-tuned-against-ground system. In either case a ground connection is required, but as the ground current is usually very low the losses should be small. We use the most convenient gas pipe, or even the low side of the 110-volt line!

Tuning is somewhat different from conventional systems. Antenna current means absolutely nothing; tuning is by r.f. tank current. To tune the system, first clip the tap on the tank coil close to the "cold" end, then tune C_2 for minimum r.f. tank current, keeping C_1 tuned to resonance either by the plate milliammeter or by tuning it for maximum r.f. tank current. When the antenna circuit is tuned to resonance, disconnecting the lead to the tank coil will make very little or no difference in the setting of C_1 for resonance, which shows that the antenna circuit has negligible reactance. Proper loading is obtained by moving the tap on the tank coil. It will be found that resonance on C_2 is sharp on the low-capacity side, but very broad on the high-capacity side. This is normal.

If the antenna is less than about $\frac{3}{16}$ wave-length long, the circuit of Fig. 3-B should be used. Tuning is the same as described above. However, all lengths greater than this will tune up with the circuit of

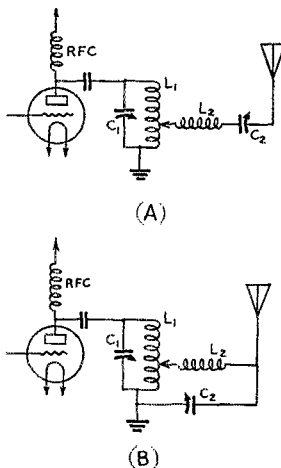

FIG. 3—ANTENNA-COUPPLING METHOD FOR FEEDING POWER INTO A WIRE OF ANY LENGTH

The antenna system is worked against ground.

Fig. 3-A, including even-number of quarter-waves. This is not true of some other coupling systems.

C_2 should have at least twice the capacity of C_1 to tune up properly with any length antenna that may be encountered. High C is desirable here, anyway. The tank coil for the next higher frequency band will usually work for L_2 , down to and including the 5-meter band.

—R. B. Jeffrey, W9ZDH

On Eliminating Harmonics

Like some other well-meaning hams, the writer ran into trouble with harmonics before becoming fully conscious of the fact that reduction of harmonic radiation is a rather tedious problem, a little more tedious and baffling than most of those confronting the ham. After groping around with it for some weeks—and having a discouraging time of it for the most part—some things were learned which may be of help to others in the same situation.

Part of the difficulty lies in the fact that unstinted care must be used or erroneous conclusions will be reached. I used a Weston v.t. voltmeter connected across a tuned circuit resonant to the harmonic, and with such an arrangement corroborated Mr. Woodward's conclusion that the way to adjust a pi-filter is to tune the input condenser to minimum plate current.¹ However, I later found that such an arrangement is not sensitive enough to detect very low values of harmonic energy and that tighter coupling forced the

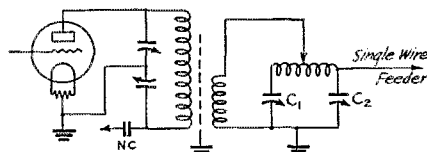

FIG. 4—HARMONIC-BUCKING CIRCUIT FOR USE IN CONJUNCTION WITH PI-SECTION FILTER

C_1 and C_2 are the normal input and output condensers used with the filter. The filter coil also has the usual values for the frequencies used. The coupling coil should have the same number of turns as the "spread" between taps in the direct-coupled arrangement. The separate pickup coil permits the use of an electrostatic shield.

circuit on the fundamental and obscured correct conclusions. Because of its large discrimination between harmonic and fundamental energies and because of its greater sensitivity I found the receiver, which happens to be an NC100 X, a much better instrument with which to check the strength of a harmonic. Thus I found in finality that the pi-filter input condenser must be tuned more accurately than can be indicated either by the v.t. voltmeter mentioned or the plate current meter of the final stage. When the harmonic

¹ Woodward, "About This Harmonic Radiation Problem," *QST*, February, 1937.

bucking circuit to be described was used the adjustment of this condenser became hyper-sensitive. This is unfortunate; nevertheless it does not alter the fact that if it is correctly set the particular harmonic is suppressed effectively even though a slight readjustment might be necessary to attain the absolute maximum attenuation after an hour's operation of the transmitter.

Another source of the error is the fact that when the strength of the harmonic is really being carried down to a very low level, practically all adjustments on the final are interlocking.

If the layout were different from the writer's it might be that attempts to determine the intensity of the radiated harmonic when bucking was applied would be obscured by the proximity of the driver stage, which produces its own harmonic. My outfit is enclosed in a steel case and when the plate voltage of the final is removed, the receiver being connected to the receiving antenna, the level of the second harmonic produced by the 804 r.f. driver is determined on the receiver to be 50 microvolts, relying on the manufacturer's calibration of this receiver. (This is entirely satisfactory for comparative measurements.) Now if the transmitter were not shielded and the level of the driver's second were 1000 microvolts on the receiving table, the detection of the null on the harmonic existing in the output would be obscured. It would thus be necessary to remove the receiver to some distance so that the results could be properly determined.

Testing over the air with distant hams is of some value but here again there is great chance of being in error because of skip, etc.

The circuit for bucking the second or any particular harmonic is shown in Fig. 4. This will reduce the offending harmonic to a lower value than can be obtained by the usual methods. The position of the tap must be determined experimentally and will vary with circuit constants, but in general it will be found near the input end of the coil. The adjustment will be found experimentally to a very close approximate degree and exact cancellation obtained by close adjustment of the input condenser. When the tap is located and the exact adjustment is made, the pi-network will manifest all its usual characteristics. For example, detuning the plate tank will produce no further dip in plate current. Restated for emphasis, the gist of the technique is as follows:

Determine that the receiver is sufficiently removed from the transmitter so that the harmonic of the r.f. driver is not in evidence. (It is most convenient if this is accomplished with the receiver in the room, so that the carrier indicator can be watched while adjustments are made. For reasons that will not be discussed, I believe that the mere shortening of the receiver's antenna would not be equivalent to removing the receiver from the room, in the case of an unshielded trans-

(Continued on page 110)

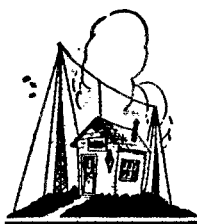

Amateur Radio STATIONS



W1AVJ, Concord, N. H.

ALTHOUGH W1AVJ is, comparatively speaking, only a "middle-aged" station—it was first put on the air in 1927—its owner, Robert V. Byron, of Concord, New Hampshire, can readily qualify as an old timer. Early interest in the "wireless" of the pre-war spark days led to his becoming an operator in the Navy during the war, when he was on active duty in foreign waters.

The transmitter and power supplies occupy the two home-built cabinets at the left of the operating desk in the photograph. Both are mounted on casters for ease of making repairs and changes. Three tubes are used in the transmitter; the crystal oscillator is an RK-39, followed by a T-55 buffer and a T-200 final amplifier. Link coupling is used between all three stages. Each stage has its own power supply. The transmitter is arranged so that the antenna can be coupled either to the buffer or the final, and the input can be varied between 75 and 900 watts. Plug-in coils make operation on 10, 20, 40 and 80 meters possible, although the set usually is on 20 or 10.

The antenna at W1AVJ is a 7-Mc. Hertz, single-wire fed, with the feeder tapped directly on the tank coil on the 7-, 14- and 28-Mc. bands. For 3.5-Mc. work a counterpoise is added, with



W1AVJ

link coupling between the tank circuit and the antenna-counterpoise. The receiver is an HRO.

Chief interest of W1AVJ's operator is in DX work; all continents were worked back in 1928,

when New England WAC's were as rare as they are now commonplace. The WAS certificate on the wall is No. 6. Big events of the year at W1AVJ are the DX and Sweepstake Contests.

W2BCP, Brooklyn, N. Y.

AN UNUSUAL thing about W2BCP—unusual at least from the standpoint of the average ham—is that the same layout has been in continual use for about five years. It must be satisfactory, or that powerful rebuilding urge cer-

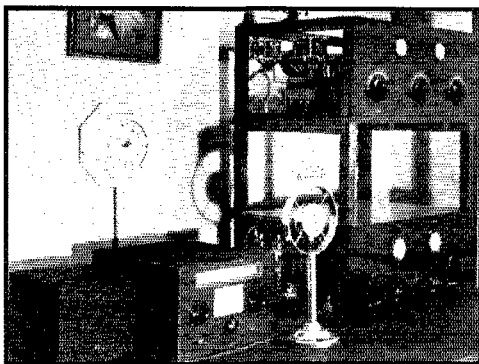

W2BCP

tainly would have got to work! The station is owned by Max G. Weinman, of 576 Hendrix St., Brooklyn.

As the photograph shows, the layout is quite neat. Transmitter and power supply are contained in the wooden frame at the right. The r.f. end occupies the upper section, and consists of a 47 crystal oscillator, using 7-Mc. crystals, a 46 doubler and 203A final, link-coupled to the driver. The input to the final is 250 watts on c.w. and 100 watts on 'phone, when the latter is used. The lower section of the rack contains the power supplies for the transmitter.

The receiver is an FB7A. The small cabinet to the left of the receiver is a speech-amplifier unit containing a three-stage resistance coupled amplifier for the crystal microphone, and using two 2A6's and a 27. The modulator unit, which does not show in the photo, uses 10's in Class-B, driven by a pair of 45's with a 59 pre-amplifier.

A shielded low-impedance line connects the unit on the operating table to the modulator proper.

Although most of the recent operation has been on c.w., W2BCP formerly was quite active on 20-meter 'phone.

W6SN, Los Angeles, Cal.

W6SN is owned by William A. Lippman, Jr., and is located at 1616 Pandora Avenue, Westwood Hills, Los Angeles. Bill has been a member of A.R.R.L. almost continuously since 1922, and has held amateur licenses since 1921, when in St. Louis the call 9AQB was acquired. During the following four years spark coil, then a rotary gap, were used on 200 meters, c.w. came into being, and the Sixth District became a reality instead of mere fantasy. After that a joint venture on 80 and 100 meters with 9CVO brought a first taste of high-powered c.w. In 1927 another call, 9FAQ, was taken out, and in 1929 the station was moved to Beverly Hills to reopen there under W6SN. For seven years W6SN worked the low-frequency end of 7 Mc. and made many friends there. Then in 1936 attention was centered on 20 meters, and when late that year the location was changed to Westwood Hills the station was built up primarily to operate on that band.

The present station is located in an especially-built room in the corner of Mr. Lippman's new Spanish bungalow, and is shut off from the rest of the house by a concealed and sound-proofed door hidden in the wall of the den. The walls of the room are Masonite, screwed on in panels for easy removal, and all wiring is behind them. No. 4 feeder lines bring 220 volts into the room from a special pole transformer, which lowers the neighbor's resistance and prevents light-blinking in the house.

As can be seen in the photograph, a trio of Eimac tubes is laid breadboard on a built-in shelf, with 35T oscillator, 35T buffer-doubler and 150T final. The circuit is conventional, and the oscillator input of 100 watts at 40 meters provides

sufficient output to drive the succeeding stages at either 10, 20 or 40 meters with good efficiency. A quick coil change moves frequency, and input to the final ranges from 1 kw. on 40 meters to 400 watts on 10 meters. Crystals are available for either end of the bands, plus some intermediate frequencies. One power supply (primary keyed) feeds the oscillator with 1000 volts. All filaments are supplied by one transformer.

At the operating position, to the right of the Breting "12" receiver is a built-in speaker and to the left is a small toggle switch that connects a similar speaker built into the living room wall for broadcast reception. Also set in the operating bench is a double-pole double-throw snap switch



W6SN'S OPERATING POSITION HAS PLENTY OF WRITING SPACE

that breaks the oscillator plate supply and the relay battery circuit simultaneously, preventing plate voltage from reaching the final through accidental pressing of the key when the oscillator is not running. A Johnson 20-meter "Q" and a Hertz half-wave 40-meter center-fed antenna complete the layout.

With the above rig and its predecessors at W6SN, all states, all continents and 73 countries have been worked. Lippman has run the gamut of experiences offered the active ham. He handled press for MacMillan and WNP at the North Pole, and talked to Byrd at the South Pole. He

has handled flood and earthquake traffic, and for many months worked the trans-Pacific route with ACSNA, OM1TB and KA1HR. In 1932 he was prominent in the construction and administration of W6USA at the Olympic Games, and was the originator and first recipient of a "USA" call for a "public interest" station. The various stations he has operated (with the exception of W6USA) have had over 6000 separate contacts (all on c.w.) of which some 2400 were foreign.

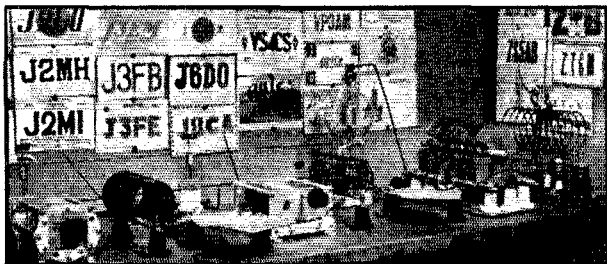

JUDGING BY THE CARDS, THIS LAYOUT IS AS EFFECTIVE AS IT IS NEAT AND SIMPLE



CALLS HEARD

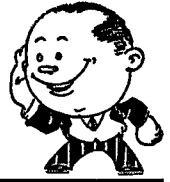

Now that our How's DX column has become so popular we will publish only Calls Heard lists that are from amateurs outside the United States and Canada. These lists should contain only calls of W and VE amateurs heard, segregating the telephone stations from the telegraph and stating on which amateur band the reception occurred. Meritorious reception done by United States and Canadian amateurs will be contained in How's DX. What say, DX? Start those lists coming!
—EDITOR

Miguel A. Rivera, Casilla 2268, Lima, Peru

(Heard at Hong Kong, China)
14-Mc. 'Phones

W1 emb ged W2 cla ikv ayb W3 emm apl avo axt W5 abq ldb W8 lka mxq dym W9 xbq

GM6BM, David W. Milne, Jr., 37 Harcourt Road, Aberdeen, Scotland

14-Mc. Band

W1 egn euz dz fdn fjn hky hqa jkt kal qf W2 brv et gqs jwz W3 hxd eih evk W4 tj zh W6 adp get inp jgg nhs nya W7 fqh W8 anb bkd bkp dhe jdb nlb not lec ze W9 avs bo kmc mkl pxn ubb wys

XU8LR, A. E. Lower, U.S.S. "Augusta," Asiatic Fleet, Hong Kong, China

(Heard while cruising in Philippines)
7-Mc. Band

VE5 kv W6 ann dsz fbp krb lpc awt ax eyo fqy gtm gnz gpu kjk kut kzh W7 fjs ean W9 ify reu W5 amo ehm jm zf

14-Mc. Band

W6 hag bip bnk nez byw cxw ejc fqy ibq ith jyh tj hew W7 bl ek W9 dzx oia tb bez W1 gsh zi W4 tr

G2BPC, H. J. Carter, 29 South Esk. Road, Forest Gate, London, England

14-Mc. 'Phones

W4 dei dsy W5 dnt eo W6 lr eul oqi ljd ele kex gvo fmy hfb ies jmr hip kwa msm exq dzk azs W7 anz fjs fec

I1KN, Florence, Italy

28-Mc. 'Phones

W1 hqn apf bqq coo tw W2 djk aog jit gah W3 po fmq akx fvo flu air W4 agb ft W8 cjm dye ebs jfc hsp oke fly W9 tbb

28-Mc. C.W.

W1 ftb elr sz htp ezm ry ewd me dze bje da iwe gsh av bft avj alb zb fpp her W2 liq jad tp bux jdf exb eko hyt jme hgu igp jwz dvm jab hfn mb cok bg odl hhg dfn fhi aif grg awu cpa obo bqk acy aut ayy gum bdz bj W3 ghs czo iu fbg brz jin exb aiu epv bgr md fgw atr he eqs ennm dbx fqp egu flk W4 dek mr bfj nt W5 bee wg dqd W6 bam cxw hb jju grx jbo W7 eqz W8 mwl djf biq mwv hrd hgw kyy nhq eud anb jlq ifd aad jtw iil njp luq eky dmk eyt qye cte ano au W9 pst mtm dn tbb rrt tpi flh arl dwu rbi lq

14-Mc. C.W.

W5 cam fj dui lw fnh bfa W6 evd bam joh dhe lev ldj edx eqj jju ioj fks ti cxw grl grx fzy exq W7 etk mb fjs fys byw fb shx dsz

ZL4EG, Neil C. Gilchrist, Oamaru, New Zealand

14-Mc. 'Phones

W1 ifb jed qm aiq ajz jmb adm W2 ixy hs dx huq ewc epy cif ah W3 anh air fih eww bfh W4 cra dqx ah oby bfy aky W5 bee aij W6 an eqi bay ah mxk oqi nkx kso cou yu mbe W7 ao ml bl fqk W8 Joy W9 ruk xvz ml nlp

Robert Muguet, 58 Rue de Verdon, Meudon (S. & O.), France

28-Mc. 'Phones

W1 aak aiq bje bby bqg coo egy epd dqk dbe dnl dey elr hqr jdw sz wv W2 amm amj ag abi baa opa epz flo dxj gjk gdf hhu hgu hpc isy jao jrr jux kax kbg ze W3 akx bnc blo ery erg emm fxc fvo fhu fkk gpm ghf iu iz pe W4 cyu drz eev dbm eeb edq ft ye W5 bmm bok eaz dnb za W6 ark ekr jju jrr mdn nlf nls nap qf W7 axz bqz ckg epu fdl gee W8 bbo bbb bmad eim eyt efd dw fe gly hfp hnp jfc mah mwl njp nxq pbe W9 aza aze bhp bbu dku ekb enu faa oso yud VE2 kx W3 nd W4 be ph rc W5 tv

14-Mc. 'Phones

W1 blo ghb ixo ixy W2 alw skz ayv een jkq W3 anh bma oby eud fih mah pe W4 apk azk cyu cra cpy flo dxj gjk dsy hfs ye W5 apw blw etc eww zh W6 am bay cqi ejo grx hke hjt hgp ish km ngu oph oka rth uf kyg W7 beu bqj esk ft fu md W8 irk bf ena adm rd gic zn VE1 bv er VE2 aa ab be bg de ex fk gt hl am ev VE3 ack bb bk eo hx jv nb qz yv VE9 af al ar

I1ER, Italy

14-Mc. 'Phones

W2 ixy W3 ail erg W4 deq W6 ich

28-Mc. 'Phones

W1 eoo gpe ixt

28-Mc. C.W.

W1 adm as bux cgm egy da dfr dzb dze ewd gdy jiz me sa th tr tw zb W2 aog aut bhx bqk ebo cdl che cpa cto dsb dth fhi gum hyt jme mb za W3 air axu ddx emm evt fkk fqp kt pc W4 ah auu edq ye W5 vv W6 iht W8 anb eyt dmk dye fjn hrd kkm ifd iil iot iwg jfe jmp lec lda luq mwy njp ok oke qdu qy W9 adm arl evi gl ka iwx jdd ldl lqe mxw pst pwz tjj tpf tpi uhm VE3 kf

14-Mc. C.W.

W1 adm afb apu axa bft bgy bz egm egh ch dao dbg dhe dja duk duj dze equ et eve ewd eyy ez fau ftr fuy gkj her hio hm tbo tey igr isx iwo ixe ixy jde jlt jly jvx lz mp na ni pl sz zi W2 adp agw ahe air aiw alb ald alk alo arb awf bek bef bhv bhx bnx byk eim emx etc eto euq djb dbt dnu doe dsb dzo emj ewd foh gra gud gum gvx gvr gym hfp hfh hym hxt iop iuv iyo kl jab jno jt li mj oa oc se uk za W3 aiu anh ans anz app bal bdi bek ben bli bqp bsb bsy bxg bz edq egy che eub daj dal dmq dys eos egn eil emm enx

ev evt eys fdj fgk fgk fgp fre fwh gad gap geh gip gms grp
pe uva W4 ael agb agi ah aqu bwz oby opz era czs dcz
dqh dqx dy dx dyb dzo dsz id lx ne nn to ye zs zh W5 bxn
dew dn ehm ekk fna fyn hjt je vv W6 am azz bam ed edq
qql ckw ew foy grb grl grx hjt jbo jch jkh jja jwt kqh kri
kut kwa lae lko lym lwp mhh muo mys nsa pzl W7 amq
amx avr ayj bac bd bvi byw ek fwd lec W8 aat aro av bai
bdy blp bnx bqj bti edv elm cij emb eok dae dgp dlt dml
dod dqu emw feb fin ghn gwt hyc hwe ill iot ken ko jdb
jfe jfn jin lap lcn lec lir luk lzk mah mey mq mty nik nuy
nv oke oof oto qdu qum toe W9 afn afo agn ari bpu eww
dgt dma dnp eh ezv fdo fs fso fyy hfj hxm kyu jfb lki lju
mv mwh nst plm psq pst pv req rh sqz tb tpi um uox usz
utt uyf vin vqw wks VE1 ax ec VE2 ax bk VE3 jt qh VE4 ro

*G6YL, Miss Barbara Dunn, Felton,
Northumberland, England*

28-Mc. C.W.

W1 eh ezi fsh hio ikt iwe kad qp ry sz wv W2 aoo bdb cko
cok dvy eql eny fgh ion ipi jiz mb tp W3 air asw bgu biw
bwa duk fbo fqw W4 elq mr ye W5 aqs ayn bxc ona ddp
dge dm dgd drf dxu eb ehm fbq fhj fnh ise fuy lw ql yf W6
bam bmw boy byb cwx dob dvt ert frq hb ird ixc jbo jju
jn jnr kbd knf lac mpk nya qb W7 amx bac bd dsz gbi
W8 aaj anb euk fjn hyc jll lac ldr mah njp ss W9 aiw arn
bbu bht bwt dxx huv igz kje opu pqw sii uku uyd wtz

28-Mc. 'Phones

W2 drv W3 cbt fbo

14-Mc. C.W.

W5 aca aed afx bfa bno brn dfo dm ehm ekk eul eze feq gad
vv yj W6 al aov az azz bam baw bax bvk bvx bxi cd eri cso
cxw dob ele exq fik fke fkr fzq gqy gth ghu gpp jmr jnr
kin kip kql kth ku kut kwa lac lym mfu msm olb qd ti tt
W7 amx aij avl bac bme bpl btb bvi cmm cqr eyt dsz ejd etn
exz fd fof fqh gdw ggz W9 lry lw gdh ovu tb uii

*W2BVJ/WBEF, C. A. Luckenbach, On
Board S.S. "Exochorda," Genoa, Italy*

(Heard off the coast of Syria and Palestine on a 3-tube
regenerative receiver)

14-Mc. 'Phones

W1 adm aqm sz jza kj W2 aea akd ajy bro cbo ciz cwo dsb
eah eti fba fcb fpb ha ixy jme mj uk W3 abn anh cliq crg
dll drr exa fam fbh fih fiu xam W4 agb ah cby eyu deq dlh
drd dsy eja hx oc ye W8 bj bkj gle gly hqw nv qho rl

*W4RU/KORB, E. E. Pearson, On Board
S.S. "Sundance," Lat. 50.15 N., Lng.
3.02 W.*

28-Mc. 'Phones

W2 jme W3 aeg air bde biw bnc cim cry dly dwe emm erp
fea fgj fiu fvo fxe gej ghs W4 dek edq ft gb to W5 asg W8
ano bk exr dee jfe njp nxf oke out W9 bez ci eev dpv eyd
jbo kpd lq mhm pmp yhq

11KT, Italy

14-Mc. 'Phones

W1 blo bqg chg det ij kj lay W2 aig et zo W3 anh dpe emm
eoz xan W4 blh die W8 gle qho eko gly mrr

*VQ4CRE, S. A. Pegrume, P. O. Box 1093,
Sixth Avenue, Nairobi, Kenya Colony*

28-Mc. Band

W1 ics W2 jf W3 fgw po jm W4 ft ye W8 cdu aad W9 pby

*Karl G. Schlegel, Holderbuschstr. 7,
Stuttgart-Vaihingen/f, Germany*

28-Mc. 'Phones

VE2 kx W1 ama arb bqg cd eoo dbe dqk dsy ekt fza gde iao
liq ipo ipv jie kjj W2 amj aog flo hgu ilo iks isy jao jas jfi

jit jrr kax kbg khr W8 aeg cbt fad fvr giz kry pm W4 avd
eew egg W5 za W8 bw hsz isc iw kfe kpz okk pol W9 bht
ekd kbd mch mxw ofl peo ppd qi tlq tt uhi ulj

*A. G. Moore, 92 Princess Highway, Arn-
cliffe, Sydney, Australia*

14-Mc. 'Phones

W2 icy W3 eww W4 aeo azk dbc dlh drz W5 dew

*SM7UC, A. Nordgren, Villa Tuna,
Akarp, Sweden*

28-Mc. Band

W1 bje egm cky cux eio ffp fy ica ikt kh ry W2 amf amu aog
bef bqk cdl cko cok cto dvm fgv ghr gum hgu igp jvo jme
jxz W3 cbm cry fqp fvo jm po zx W4 aiy bsj dtr edq eeo
W6 dob hb jju W8 anb ano apq azd ejm dlu dne dye jfe
jmp mwy phd qdu W9 amm eje eow fs neu sie two yqn yyn
VE2 ax bk ew ka VE3 du kt fy

*W1ABA/W1ISQ, On Board T.E.S.
"Darien"*

(Heard at Santa Marta, Colombia)

14-Mc. Band

W1 apj amp bxr cdx dfk ga gpf gvh hmh hri icw na zb W2
cmm ddu VE1 bk VE2 ed dl if VE3 il rw sq VE4 abp

7-Mc. Band

W1 afy byi bng dqk dtb ez fkl fyy fzz gix hyv imb jhy jim
jpp jri jxv kiy VE1 ew du kf VE2 lk VE3 xy VE4 aam aed tq
zy VE5 bo hp maw hr pp

3.5-Mc. Band

W1 anr W2 dvo gzi W4 dpj W6 nra W8 bre cib kun nqz

CQ PITC!

LITTLE did we realize, when we published WSIGQ's absorbing story of radio on Pitcairn Island last month, that we were thereby triggering off a movement to provide these people with the new and modern radio equipment that they need so desperately. But we were! Evidence of a spontaneous reaction has come already in the receipt of many letters (each mail brings more) expressing a genuine desire to help, a firm intention of really doing something about it, and requests to A.R.R.L. to see to it that steps are taken to provide these people with new equipment to replace the ancient gear now rapidly losing even the small usefulness it formerly possessed.

Are we going to do it? Indeed yes! You can't stop a landslide! This notice, therefore, hastily inserted just as we go to press, is a preliminary announcement to the many who have expressed themselves on the subject that the A.R.R.L. is "heading up" a movement to provide PITC with the essential 600-meter equipment they need. Every ham will have a chance to contribute. Details in the next issue of QST; watch for them!

• I. A. R. U. NEWS •

Devoted to the interests and activities of the

INTERNATIONAL AMATEUR RADIO UNION

Headquarters Society: THE AMERICAN RADIO RELAY LEAGUE, West Hartford, Conn.

MEMBER SOCIETIES

American Radio Relay League
Associazione Radiotecnica Italiana
Canadian Section A.R.R.L.
Ceskoslovenski Amatérni Vysilací
Deutscher Amateur Sende-und-Empfangs
Dienst
Experimenterende Danske Radioamatører
Irish Radio Transmitters Society
日本アマチュア無線聯盟 Japan
Liga Colombiana de Radio Aficionados
Liga Mexicana de Radio Experimentadores

Magyar Rövidhullámú Amatőrök Országos
Egyesülete
Nederlandsche Vereeniging voor Internationaal Radioamateurisme
Nederlandsch-Indische Vereeniging Voor
Internationaal Radioamateurisme
Newfoundland Amateur Radio Association
New Zealand Association of Radio Transmitters
Norsk Radio Relæ Liga
Oesterreichischer Versuchssenderverband
Polski Związek Krotkofalowcow

Radio Club Venezolano
Radio Society of Great Britain
Rede dos Emissores Portugueses
Reseau Belge
Reseau des Emetteurs Français
South African Radio Relay League
Suomen Radioamatööriyhdistys r.y.
Sveriges Sandareamatörer
Unión de Radioemisores Españoles
Union Schweiz Kurzwellen Amateurs
Wireless Institute of Australia

Conducted by Byron Goodman

The Amateur Regulations of the World: 1937

Each year we try to bring, through this column, a recountal of the conditions and regulations in the countries represented in the Union. It is interesting to compare the advances made during the past few years in those countries that heretofore were quite badly restricted, and the outlook for the future is good.

Australian amateurs are allowed all of the amateur bands except the 160-meter portion which is available only by special permission. License fees are required; the maximum power input allowed is 25 watts. All bands are open to telephony; third-party traffic is prohibited. The W.I.A. has 900 members, 600 of them licensed amateurs.

In Austria the 160-meter band is not available to amateurs, the 3.5-3.6 and 56-Mc. bands are available by special permission, and the 7-, 14-, and 28-Mc. bands can be used by all. License fees are required, depending on the power limit used, and the maximum power allowable is 50 watts. Radiotelephony can be used through special permission; third-party traffic is prohibited. The O.V.S.V. has 180 members, 38 of them are licensed.

Colombia is coming along, and all bands are available to amateurs, with telephony privileges in each band. License fees are required; no power limit has been set yet. Third-party traffic is prohibited. The L.C.R.A. has 200 members, 50 of them licensed.

In Czechoslovakia only the 80-meter band is limited, with 3500-3600 kc. available for general work and 3600-3700 kc. to be used only for communication within the country. Telephony is allowed on this domestic band and on frequencies

higher than 28 Mc. License fees are required; the power limit is 50 watts. The C.A.V. has 860 members, 340 of them are licensed.

In Finland only the 160-meter band is denied, and telephony is allowed in all but the 7-Mc. band. License fees are required; the power limit is 200 watts. Third-party traffic is tolerated. The S.R.A.L. has 235 members, 228 are licensed.

France is very liberal with her amateurs,



SOME OF THE D.A.S.D. GANG FROM HANOVER TAKE A CRACK AT THIS FIELD DAY BUSINESS

A shot of portable D3ATK. Ex-D4LAJ is at the key, and DE-2509/K is helping him copy. The rig is an 802 e.c. oscillator driving an 803 on 14 Mc. During the ten days the station was set up, WAC was made three times, once in four hours. Over 260 QSO's were had, and 59 reports were received from every W district. D4KAK, D4NMG, D4SZK, D4ZMI, D3AQK, and D3BXK were among the operators.

allowing all of the Madrid bands, with telephony privileges on all bands. A license fee is required; the usual power limit is 100 watts. Third-party traffic is prohibited. The R.E.F. has 1380 members, 980 are licensed.

In Germany amateurs are allowed 3.5-3.6 Mc. and the 7-, 14-, and 28-Mc. bands, with no 'phone privileges. License fees are required; 50 watts is the power limit, with 100 watts available by special permission. Third-party traffic is prohibited. The D.A.S.D. has 4500 members, 600 are licensed.

Japanese amateurs are assigned a spot frequency in each of the Madrid bands, with a tolerance that enables them to use most of the band. No license fee is required; the power limit is 20 watts. Limited third-party traffic is allowed. The J.A.R.L. has 240 members, 235 are licensed.

In the Netherlands, the amateur bands, excluding 160 meters, are assigned, with 20-kc. buffer bands. A license fee is required; the power limit is 50 watts. No telephony or third-party traffic is allowed. The N.V.I.R. has 570 members, 305 are licensed.

All Madrid bands are open to New Zealand amateurs, but to operate on other than 80- and 160-meters the applicant must pass an operating test given by the N.Z.A.R.T. which forwards the recommendation to the P & T Department. A license fee is required; telephony is allowed on 160, 80, and in 500 kc. of the 10-meter band. The power limit is 100 watts; third-party traffic is prohibited. The Association has 650 members, 450 are licensed.

In Norway all the bands except 160 meters are allowed, but buffer bands of 40 kc. on 3.5 Mc. progressing to 100 kc. on 28 and 56 Mc. are imposed, with all bands open to telephony. The power limit is 20 watts in the antenna; third-party traffic is not allowed. A license fee is required. The N.R.R.L. has 250 members, 120 are licensed.

Portugal allows all but the 160-meter band; the power limit is 300 watts. A license fee is required; third-party traffic is prohibited. The R.E.P. has 300 members, 280 are licensed.



LIEUT. GUY DE BORCHGRAVE, ONAID, THE NEWLY-ELECTED PRESIDENT OF THE RESEAU BELGE, AND SECRETARY OF THE FEDERATION DES EMETTEURS BELGES

Lieut. Borchgrave is an artillery officer in the Belgian army, and also an engineer. He has been a radio amateur for the past 15 years, possesses a thorough knowledge of technical radio, and has given new impetus to the Reseau Belge.

In Switzerland 1715-2000 kc. and 3700-3800 kc. are available under special permission, with full Madrid assignments otherwise. Radiotelephony is allowed on all bands. There is a license fee; the power limit is 50 watts. Limited third-party traffic is permitted. The U.S.K.A. has 220 members, 70 of them licensed.

All bands are open to amateurs in Venezuela, with 'phone on 20 meters and above. There is no license fee; power is limited to 200 watts. Third-party traffic is not allowed. The R.C.V. has 185 members, 65 of them licensed.

Generally speaking, amateur radio is regarded favorably in most countries. Although some of the European countries do not have the privileges enjoyed in the United States, still others have fewer restrictions, such as those concerning signal quality and 'phone assignments, and the tendency is definitely towards a more liberal attitude and understanding.

WAC:

There are but two types of WAC certificates issued by the Union, one for c.w. and one for telephony, regardless of the frequency used. However, many have requested that a notation be made on their certificate that, for example, "all contacts were established on 14 Mc." We have done this in the past only in the case of 28

Mc., feeling that there was no need for any special mention of work on other bands. However, many now possessing WAC certificates for work on the lower-frequency bands have qualified for a 28-Mc. WAC and have applied for one, only to be told that they have a WAC and all we can do is note on their present certificate that they have qualified on 28 Mc., and at what date. Most have been reluctant to send in their certificate for this endorsement. Therefore, to simplify the 28-Mc. endorsement business

we have prepared small transparent labels that can be attached to the present certificate, giving the call of the station and the date of qualification. Any present holder of a WAC certificate who has qualified for a 28-Mc. endorsement can obtain the endorsement by submitting his cards or statement from his membership society to the headquarters office. Be sure to mention the date of issuance of your present certificate.

QSL:

The list given in the May issue of *QST* should be corrected as follows:

(Continued on page 102)





OPERATING NEWS



Conducted by the Communications Department

F. E. Handy, Communications Manager

E. L. Battey, Asst. Communications Manager

THE LEAGUE is the organization group working for the individual. There is nothing quite like organization. By joint effort, through organization, progress for any group is attained. The secret of organization is coöperative effort. It is only necessary that each individual having interests and rights in common with other amateurs lend his full support to the organization. To get maximum benefits one must be a member. Which leads us to ask:

Are you an A.R.R.L. member?

Did you ever get *another* member?

The Communications Department of the League is concerned with the practical operating of *all* amateur groups. Plans are made for emergency work, for 'phone, traffic and DX groups, for systematized operations on all amateur frequencies. It is not the aim of the League to change the hobby of DXer, traffic man or rag chewer from one branch of amateur activity to another. At one time or another in his amateur career (or perhaps even in a single night!) one amateur can become a participant in each type of ham work. In addition to furthering our respective abilities to serve the public through general operator training and emergency preparedness, it is our constant aim regardless of a special interest, to benefit all amateurs concerned along each line of natural interest.

To that end we announce activities having a wide variety of objectives and with participation not limited to any small group. For qualified member operators whose aim is high and whose activity is continuing, membership in Official Relay Station and Official Phone Station groups is attractive. A.R.R.L. Trunk Lines are maintained by outstanding and skilled traffic men. Besides contest activities definite point is also added to amateur operating through recognition in the following:

- A.R.R.L. Emergency Corps (A.E.C.)
- The A1 Operator Club
- Rag Chewers' Club
- Brass Pounders' League
- W.A.S. (Worked All States) Club
- W.A.C. (Worked All Continents) Club

Elsewhere in this issue is announced a new "Club"—the "DX" CENTURY CLUB with full specifications on qualifying. It is a form of

special certification or recognition for outstanding DX men in our amateur ranks. When you have *confirmed contacts* with some 75 or more countries to your credit you "rate" and start working for the full 100 that constitutes the century mark and a certificate! It is plenty hard to make the DX (Century club) *QST* list. This will record progress between 75 and 100-or-more countries in the same way that the B.P.L. marks the monthly traffic highs for the traffic man. The membership in this group will be quite an exclusive and top-notch honor among those to whom DX is the main object. For those who have suggested that W.A.C. is "too easy," here is something new to shoot at. Like W.A.C., confirmations all must be submitted and checked at Hq. in qualifying. If your chief interest is in DX we invite your attention to the announcement. The new certificate will be reproduced in *QST* soon together with lists of those who make the grade. Can you qualify?

All members of the fraternity also have their attention cordially invited to the other A.R.R.L. awards, and likewise to the appointments in special field organization groups. If you are an amateur interested in doing things and keep a station active, you ought to get in on all the activities, do things with your station with others receiving appointment, and get the bulletin news and information swapped between Hq. and members of the groups. The appointments further useful amateur objectives and there's prestige in holding one of them down. The S.C.M.'s (see page 5) handle organization appointments. A postal card to A.R.R.L. Headquarters will bring you application forms and an operating booklet with useful operating helps and full information on these matters.

—F. E. H.

Announcing: The DX Century Club

THE A.R.R.L. Communications Department announces a new DX award to be made to any operator who can submit satisfactory proof that his amateur station has been in communication with 100 or more different countries. The award will consist of an attractive certificate of membership in the A.R.R.L. "DX Century Club." It is further planned to list in *QST* each month the calls of all active amateurs who have worked 75 or more different countries and submitted proof of same to A.R.R.L. As additional countries are contacted and confirmations received, said confirmations may be then submitted and the total of countries worked

will be changed in subsequent issues of *QST*. In this manner a standing record of proven accomplishment will be available for all amateurs working 75 or more different countries. When a station reaches the "100 countries" mark, it will automatically receive membership in the "Century Club" and the certificate award will be made.

An invitation is hereby extended to amateurs everywhere to join the "Century Club" and to submit proof of contact with 75 or more countries for the official *QST* list. If you can produce confirmations of QSO's with 75 or more countries, bundle them together and mail to the A.R.R.L. Communications Department, West Hartford, Conn., together with sufficient postage to guarantee their return to you. Your official "proven QSO record" will be listed in *QST*. If you hit the 100 mark, you'll rate the "Century Club," a truly singular honor. Who will be the first to qualify for this new award? How many will make the first listing of 75-or-more-countries-worked? The first list will appear in November *QST*. Check up on *your DX now* and if you find 75 or more countries represented, send in the confirmations right away. All we ask is that you adhere to the following rules:

(1) All contacts must be made with stations working in the authorized amateur bands using amateur calls.

(2) All stations contacted must be "land stations" . . . contacts with ships cannot be counted.

(3) All stations must be contacted from the same call area, where such areas exist, or from the same country in cases where there are no call areas.

(4) The A.R.R.L. list of countries (page 51, Jan. '37 *QST*) will be used in determining what constitutes a "country."

(4A) In cases of countries no longer in existence, credit will be allowed for these, if they were recognized as separate countries by A.R.R.L. at time of contact.

(5) Confirmations must be submitted for all countries claimed; requests that DX contest and other contest logs be examined for confirmations will not be granted.

(6) Contacts may be made over any period of years, and may have been made any number of years ago, provided only that all contacts be made from the same call area (or country, where no call areas exist) and by the same station licensee; contact may have been made under different call letters in the same area (or country), if the licensee for all was the same.

(7) The Century Club award and *QST* listing for confirmed contacts with 75 or more countries is available to all active amateurs, everywhere in the world.

(8) Following the first listing of any station in *QST*, confirmations from additional countries may be submitted as received, and the original listing will be changed in subsequent lists.

(9) Stations reaching the 100-confirmations mark will automatically be enrolled in the DX Century Club.

(10) Sufficient postage for the return of confirmations must be forwarded with the application.

(11) Address all applications and confirmations to the Communications Department, A.R.R.L., 38 La Salle Road, West Hartford, Conn.

That's the dope! Now let's see some applications. It is to be emphasized that this *QST* list will be the only official confirmed list of countries worked in existence! Every real DX man will want to be included. The first list will be in November *QST*. See that *your call* is there!!

W.A.S. Club

MEMBERSHIP in the Worked All States Club totals 348 at this writing. The following have qualified since January 7, 1937: W4OG (No. 230) XE2N W8KSF W3FXZ W9KXX W8MWL W8NOT W9UM W2IOP W4AJY VE2DR W4EEE W9TJI W9GHN W7EUY W9UBB W8NUO VE4KF W8OXO W3GDI W6GTM W4BQK W5FPD W6LDJ W3GEB W7EHL W1HSC W5EOE W8ONX W5DLC W6ETX W9MIK W9UQT W2HJK W9VBQ W9VZJ W8MGC W9PWU W8LII W1GBY VE4LK W7EYN W9OAG W9VOD W5DXA W9LPX W9GIZ W2BXA W9UPW W1EEF W9HKL W3FQB VE4LV W80YI W4DSO W3EXI W9LEZ W9CUH W1JCA W8DGL W5FNA W8PQQ W9HKZ W2DPA W5BB

W2HHF W2BGO W8JAH W6EQK W3AWH W2HW W8DSQ W9VFX W3GNO VE5OT W8EBR W3FZU VE4GD W9SW W8NBK W8JW W8OMA W9TWC W7FYN W9RBI W2GFW W9CFB VE3WV W6NFC W5FDI W9GNS W9MUX W9YJL W9RXL W5DVM W3GAU W4DSY W4EY W5EDX VE3DA W8QAN W8PSR W6FBM W2BLD W9WGL W9VDY W6IAQ W8MAH W3GHD W2HDJ W8QBQ K6MUV W8OYY W6NCT VE2IF W2API VK6SA W3EXB W8JTW (No. 348).

An inspection of the entire W.A.S. list shows some interesting things. There are W.A.S. Club members in every state but five—Nevada, Oklahoma, Oregon, South Carolina and Utah. Who will be the first to qualify in each of these states? The following have qualified for W.A.S. using radiotelephone only: W8IJZ, W6ITH, W4EEE (all 1.75 Mc.), W6ETX, W9PWU, VE5OT, VE4GD, W4DSY and K6MUV (all 28 Mc.). W4PL has worked all states on both the 3.5- and 7-Mc. bands. W4BQK WAS'd using 3.5 Mc. only. WIGBY made it solely on 7 Mc., W9VDY on 14 Mc. exclusively. Club members outside the "States" and Canada are, in order of membership, OA4J, K6CGK, XE2C, XE2N, K6MUV and VK6SA.

How many states have you worked? Forty-eight cards or other confirmations submitted to the A.R.R.L. Communications Dept. as proof of contacts with the forty-eight United States will make you eligible for the W.A.S. certificate. Sufficient postage must be sent with the confirmations to finance their return. Contacts may be made on any of the amateur bands and at any number of different addresses, provided no two addresses are more than twenty-five miles apart. A special rule permits either a confirmation from the District of Columbia or one from Maryland itself to count for the state of Maryland. Send your confirmations as soon as you can qualify!

W3FTK Wins '36-'37 O.R.S. Competition

THAT handsome Winston-Salem (W4NC) O.R.S. Cup Award put up in the all-season competition has been awarded to Jim Laughrey, W3FTK, for the best all-around O.R.S. performance. Three A.R.R.L. bronze medal-charms go to the three highest operators, W3FTK, W3EOP and W6KFC. These leaders stood as follows in the final tabulation:

	Traffic Record	% Activities	Total Per Cent
W3FTK.....	50	39	89
W3EOP.....	30.5	46.25	76.75
W6KFC.....	25.15	50	75.15



JIM LAUGHREY
W3FTK, WINNER OF
THE WINSTON-SALEM
AMATEUR RADIO
CLUB (W4NC) CUP
AWARD IN THE '36-'37
ALL-SEASON O.R.S.
COMPETITION

"Traffic skeds" won out for W3FTK. Consistent quarterly activity helped him place well. One had to watch all the factors, as was pointed out from the inception of the contest. It was "neck and neck" between W3EOP and W6KFC for much of the contest-year. Congrats of all to these winners.

O.P.S. Contest Winners

TIBBETTS of W6ITH wins the striking Trophy donated by the O.B.P. chapters at St. Louis and Kansas City as the leading Official 'Phone Station operator in the '36-'37 all-season operations. His report of operations and research filled some 45 carefully prepared sheets. Practical conclusions covering investigations on everything from antennas to practical life tests on types of pulleys for radio masts were included. 'Photo of W6ITH and the station performance in the last "SS" have already appeared in *QST*. Medallion awards go to both W6ITH and to Denlinger of W3BRZ, for their excellent standing in work within the leading 'phone organization group of the country.

Both entrants did an excellent job of operating in addition to making practical and theoretical investigations, constructing new equipment and keeping logs and records above average ham standards. W3BRZ's high standing in the 28-Mc. competition will also be remembered—his results outstanding with employment of moderate power in experimental set-ups for month after month comparisons of results.

The evaluation of points:

	Experimental and Construc- tional Points (50)	3 Activi- ties (20)	Station Log and Records (10)	General QSOs and DX (20)	Total Per Cent.
W6ITH	50	10.56	10	20	90.56
W3BRZ	35	20.	10	15	80.

All amateurs not now members of Official Relay Station and Official 'Phone Station groups have their attention called to the fact that this season's plans will be announced very shortly. If you do not now hold appointment as a member of one of these leading amateur groups, we suggest you drop Hq. a line for information in whichever appointment you are interested—and get lined up with your S.C.M. as early as possible in order not to miss out on fall plans.

O.B.S.

The following is a supplement to the list of A.R.R.L. Official Broadcasting Stations in October *QST* (page 122): W1JYE, W9SYJ.

Hams Afloat

W9LNX sends word that he is making three relief trips as radio operator aboard the M.S. *Bidwell*, KESQ. . . . After returning from a four months cruise as Chief Operator on the Yacht *Caroline*, WDEC, W3GLH has been assigned to the Yacht *Sumar*, KGCF. . . . W3DWM is now a Cadet on board the Training Ship U. S. S. *Annapolis*, Pennsylvania State Nautical School. . . . The rig on the Str. *Philip D. Block*, WCDG, is a pair of '04A's in an a.c.c.w. self-excited circuit with 500 watts input of 500-cycle a.c.; this boat is in the ore trade and makes all ports of the Great Lakes; W9RFJ is operator. . . . Duane F. Anstett of Seattle, Wash., sends the following dope: W7BTW is operator on the *Victoria*; W7BHL on the *Derby*; W7DHC was on board the *Colorado* when in search of Amelia Earhart. . . . W9DBF is Sparks on the S.S. *James P. Welsh*, Great Lakes. . . . W6MCU is operator on the S.S. *Cascade* plying between San Pedro and Puget Sound. . . .

56-Mc. DX Schedule

ON4AU announces the following schedule for 56-Mc. work, every week-end, October-February: Frequency, 56,080 kc. Saturdays, from 1400 to 1700 GT; Sundays, from 0900 to 1000 GT, and 1400 to 1700 GT. 15-minute calling and listening periods will be alternated, the first 15 minutes of each scheduled period being for ON4AU's calls, he will listen the second 15 minutes, and so on. ON4AU will also operate on 14,116 and 28,232 kcs., shifting to 56 Mc. for tests with amateurs worked.

PRIZES FOR BEST ARTICLES

The article by Mr. Herbert Spohn, W2GMM, wins the C.D. article contest prize this month. Each month we print the most interesting and valuable article received marked "for the C.D. contest." Contributions may be on any phase of amateur operating or communication activity (DX, 'phone, traffic, rag-chewing, clubs, fraternalism, etc.) which adds constructively to amateur organization work. Prize winners may select a 1937 bound *Handbook*, *QST* Binder and League Emblem, six logs, eight pads radiogram blanks, DX Map and three pads, or any other combination of A.R.R.L. supplies of equivalent value. Try your luck. Send your contribution to-day!

Calling

By Herbert Spohn, W2GMM*

IT seems as though some fellows are unaware of the length of time they take in calling a station. Perhaps a little consideration will be of value to the whole fraternity as it will reduce needless QRM to some extent, if nothing else.

Quite a number of articles have already appeared in *QST* in regard to long, drawn-out CQ's and it is therefore unnecessary to enter into any lengthy discussion about this practice, except to state that a great number of operators still seem to favor the system. Is it impossible to reform these fellows who call CQ 50 or more times before inserting their call? Newcomers, at least, should be informed of the correct procedure to use, after QSO has been established, if they CQ too long. It's no use for the new fellow to form bad practices, since any good operator is sure to pass up these long CQ's. Can't we inform them, or don't we have enough grit to do so?

Answering a CQ is the subject upon which I wish to dwell. First of all, you know your own frequency regardless of the type of oscillator employed. That is, you know where your frequency is on the receiver, at least. Now then, determine how long it takes to cover the dial from the nearest end of the band to your frequency. This can readily be done by calling CQ and tuning across the band to your frequency and noting the time it took to do so. This, of course, would be on an occasion when you received no reply to your CQ on reaching your own frequency. To this time add, say, one quarter minute more (perhaps a half minute if you are located well toward the center of the band) to make up for differences of time employed by various operators in tuning their receiver, and call a station this long in answering a CQ before signing your call.

As my frequency is about 15 kc. from the band's end, I call about a half minute before signing my call, which is ample time for anyone to hear me and adjust his receiver for best reception. On quite a few occasions I've heard fellows on the same frequency as the station I was calling, that was only 20 or 30 kc. removed from the end of the band, futilely calling a minute or more longer, whereas the QRM was negligible. I have tried several times at merely calling the station three times, then sign, and in most cases received the reply. Some operators call 5 or 6 minutes, while actually 2 minutes would have accomplished the same result.

There are also the fellows who sign their own call from ten to fifteen times, causing needless QRM. Just why should it be necessary to go to such length? If one's signals are QRM'd, the chances are that no QSO will result regardless of the number of times that one signs his call. I have found that signing my call briefly is quite sufficient in all cases after calling the desired station.

In subsequent transmissions, when replying, calling the station three times and signing once is ample. After all, contact is already established. Especially is this applicable to crystal-controlled DX stations who make lengthy calls

* 121 Lake Street, East White Plains, N. Y.

in replying before commencing with the QSO. Then, at the end of the transmission, there is no need for sending the call of the station more than once, nor is it necessary to sign your own call more than once.

All this leads to more enjoyable QSO's in shorter time with less QRM on the band. The net gain is more minutes of actual QSO per hour. How about it, fellows, don't you think it's worth considering? Try it.

The A.R.E.S.—1.75-Mc. 'Phone

AFTER several weeks of planning and study by W5DVK, W5CL and W5FQQ, the Amateur Radio Emergency Service held its first drill December 17, 1936, with fifteen members present. The A.R.E.S. is a 1.75-Mc. 'phone net organized for tropical storm emergencies. There are four districts. District One includes the lower Rio Grande Valley; District Two includes the Corpus Christi district; District Three the Houston area; District Four the San Antonio area. W5DVK at Portland, Texas, is the Area Control Station.

Each District operates on a special frequency: Dist. One—1972 kc.; Two—1865 kc.; Three—1946 kc.; Four—1950 kc. District Control Stations collect weather reports from all stations within their districts and report to the Area Control each Sunday morning at 8:30. After all reports have been assimilated at the A.C.S., tropical disturbances can be located and the direction of travel determined. The A.R.E.S. drills each Sunday from 8:30 to 9:30 A.M. The D.C.S. call the roll of their district, collect reports and forward them to the A.C.S.

Every A.R.E.S. station is required to have such weather instruments as barometer, thermometer and wind indicator. Portable transmitters are also a requisite. Talks are given during the drills on such subjects as "Cyclonic Storms," "How to Build a Mercury Barometer," "How to Locate a Tropical Disturbance," etc. In addition to tropical storms the A.R.E.S. stands ready to assist in all other emergencies. During a freeze at Tyler, Texas, the Houston D.C.S. handled all traffic coming out of Tyler for 24 hours. During the flood the organization kept its lines open for emergency traffic.

Promptness at drills, accuracy of reports and drill attendance are the things stressed in the A.R.E.S. regulations. An amateur must attend three drills before becoming a member. He must remain active, observe the rules of the net and make an attendance record of 100 per cent (with excused absences only) to remain in the group. Members of the Amateur Radio Emergency Service are: District One—W5CL (DCS) W5CHE W5ENR; Dist. Two—W5DVK W5FZB (DCS) W5ERC W5EYV W5EVA W5GBR; Dist. Three—W5FQQ (DCS) W5GAU W5EXC W5GEU W5BYX W5EEH W5FHD W5UW; Dist. Four—W5EPB (DCS) W5FNY W5FFG W5EIB W5FAH W5FNH. North Texas, Louisiana and New Mexico areas are being organized with W5FAC, W5WN and W5FUA, respectively, in charge. Amateurs interested in joining the A.R.E.S. should communicate with the D.C.S. in their district for further information.

W3USA

A 1-kw. amateur radio station was in operation at the 1937 National Boy Scout Jamboree at Camp Roosevelt, Washington, D. C. The call letters were W3USA. The main equipment was furnished by the Coast Guard. The transmitter was a Collins 20-B using P.P. Federal 100A's, an exact

duplicate of Byrd's South Pole rig. Receiver was an ultra-modern job especially designed for the Coast Guard at a cost of \$750. The antenna consisted of a 93-foot vertical radiating steel mast, which has been adopted by the C.G.; it was designed by A. W. Hopkins of the Coast Guard and is able to withstand a 150-mile gale. W3FKQ was in charge of operations. Operators were W2SN (Chief op), W3FYG, W9ZAW, W8PBV, W5GAB and W8PAJ. The Washington Radio Club gave full cooperation in the handling of traffic. W3GGX was chairman of the W.R.C. Committee. W3USA handled 520 messages from June 30th to July 4th. Schedules were maintained with W8MQX HMJ GUF L.DA LFF AAU GUM GWT MPQ W2GBO CGG DGU W3SW CWE ADM CIZ CFB W4DAW EJV W9AIR SQD WLM/W3CXL. Washington amateurs who helped clear traffic from their own stations were W3BWT EHW AMU GXI FPQ. W3USA was on the air 24 hours per day. Chief Operator Yahnel, W2SN, expresses thanks to all who directly or indirectly aided in making operation of the station successful.

Radio for the Blind

W8QVO is the station of the radio club at the Pennsylvania Association for the Blind, Pittsburgh. This is believed to be the only organization for the blind holding an amateur call. Fred Stiening, W8FIP, O.P.S., trustee for W8QVO, instructs a weekly class in radio at the school. About thirty students are enrolled. Almost totally blind himself, he has been endeavoring to interest the blind in the recreational possibilities of amateur radio and the general satisfaction that comes from studying a modern popular subject. One of his pupils, W. L. Bassett, recently passed the exam and obtained the call W8RBA. Mr. Stiening writes, "I realize that there are a scattered few blind fellows, who, through their own ingenuity, or more likely through fortunate circumstances, have made excellent progress in understanding the technicalities of radio. However, I feel that very little has been done to bring this storehouse of recreation to the average young blind person. Amateur radio is one of the most promising hobbies in which a blind person can participate." Anyone interested in pursuing this matter further may write W8FIP for suggestions and advice. His full address: Fred Stiening, 3245 Piedmont Ave., South Hills, Pittsburgh, Pa.

With the Expeditions

W9AQS has been having good success on schedules with the MacMillan Arctic Expedition, WHFN. He reports, "There have been only two or three nights that we have not worked them. Our main difficulty apparently occurs when the *Thebaud* is anchored in harbors along the coast of Labrador. As I understand it, these harbors are enclosed by high hills and it seems to have quite an effect on signal strength. For a period of several days the *Thebaud* was in a small harbor at Cape Chidley waiting for the ice to clear out of the Hudson Strait. During this period we had difficulty in copying the signals, but as soon as she left this point for Resolution Island, signals came up in strength tremendously. I believe the expedition is now (July 31st) at Frobisher Bay in Baffinland, and this probably will represent their maximum distance from the States."

WHFN asks amateurs to listen daily during August on 11,040 kc. starting at 7:00 p.m. EST. Following a CQ on this frequency operator Ramsten will listen on 7 or 14 Mc. as indicated and establish two-way contacts with those calling.

W3QP has started schedules with WAWG, the MacGregor Arctic Expedition. . . . W1ES schedules YE1IN,



THE "GOOD FIST CLUB" IS ANNOUNCED BY THE DETROIT AMATEUR RADIO ASSOCIATION TO ENCOURAGE BETTER OPERATING

A button, here pictured and actually one-half inch in diameter, is awarded to those amateurs who by their "fists" show that they have mastered the art of handling a key. The idea was conceived by W8NXT and turned over to D.A.R.A. to handle. Awards are made only after careful monitoring of the candidate's sending. The personnel of the monitoring committee is known only to its chairman in order to remove all possible pressure in selection of Good Fist Club members. Watch your sending—you may find yourself being "monitored" for this award!

the Bowdoin-Kent's Island Expedition, twice weekly. VE1IN uses 3885 kc. regularly.

Aircraft Calling Frequencies

W9MYX suggests that all amateurs add to their store of knowledge the fact that the international calling frequencies for airplanes are 3105 and 6210 kcs.

Sec. 324 of the Communications Act of June 19, 1934 reads as follows: "In all circumstances, except in case of radio communications or signals relating to vessels in distress, all radio stations, including those owned and operated by the United States, shall use the minimum amount of power necessary to carry out the communication desired." There probably would be lots of long faces if somebody started to get tough about enforcing this regulation! How about reducing power for local QSO's and all QSO's not requiring our highest power, gang?

Coincident: W9DHO had just obtained a new crystal and was doubling to 14-Mc. 'phone, 14.168 kc. He called CQ, the first with the new crystal. The receiver was set at the spot on the dial corresponding to 14,168. Upon completion of the CQ, without touching the receiver, there was W6GTL calling W9DHO. A check-up showed that GTL's crystal was also 14,168! And further, they were both using the same make receiver (Breting) and both had inputs of 135 watts.

Emil G. Nickle of Schenectady, N. Y., has an appropriate call—W2EGN. The lucky gent!

W7GGW and W7FRZ warn The Old Sock, high mogul of the Rag Chewers' Club, to watch his laurels. They held a solid 6-hour QSO on July 4th/5th . . . 10:58 P.M. to 5:04 A.M. If it hadn't been that signals started to fade they would probably still be at it.

Enthusiastic ham to choice DX: "You'd better treat me right or I'll turn my beam on you."

20 Year Club

ALTHOUGH August QST has been in distribution for about one week only at this writing, we already have received several applications for membership in the "20 Year Club," which was announced in that issue. Just look at the record of some of these Old Timers. . . . **Larry J. Barton, W6OCH**, O.P.S.: "My first transmitter on the air 1907 at San Mateo, Calif., using call LE, frequency plus or minus 600-1000 kc. In 1912 licensed as 6LB, which call ran to 1917 when closed down on account of the War. Next on as 6DCI in McGill, Nevada, in 1926. Present call W6OCH granted July 1936." . . . **F. C. Beekley, W1GS, QST's** Adv. Mgr.: "First call 3JS, Media, Pa., 1914-1917; Second 1WC, Hartford, 1923-1924; Third 1AEL, East Hartford, 1924-1925; Fourth 1KP, Glastonbury, Conn., 1925-1929; Fifth and present call W1GS, issued in 1933." . . . **Herbert A. Beering, W1GDY**: "Started in 1912 with spark coil rig; graduated to Clapp-Eastman ½ kw. job in 1914. Had the call 1KW until my license expired during the War when all stations were closed down. After my discharge from the Army, I drifted away from amateur radio and did not get back into the game until 1933 when I was assigned my present call W1GDY." . . . **Telfer C. Cooper, W8EUY**: "Used call BC in 1903 in Jersey City, N. J. Licensed as 2DR in 1912, same city. Served in Army during the War, after which again got 2DR. Later signed 1CGR, Springfield, Mass.; 2DMU, Jersey City; 3DY, Erlton, N. J. Now have W8EUY, working 56 Mc. only. Held First Grade Comm'l ticket in 1912. Was pre-War sea operator." . . . **Fred J. Elser, W1KOM**: "1911—Saw first wireless transmitter while on ship going to P. I. 1916—At school in P. I. learned the code over room-to-room telegraph line. Also learned to operate receiver which used electrolytic detector. 1917—Built first amateur transmitter in P. I. and

BRASS POUNDERS' LEAGUE

(June 16th—July 15th)

Call	Orig.	Del.	Rel.	Extra Del. Credit	Total
W6HRH	110	408	10	408	936
W8IOX	26	69	604	66	765
W3DQN	22	64	466	52	604
W81MI	93	80	203	165	541
W61TH	84	78	207	159	528
W6LLW	17	24	458	15	514

MORE-THAN-ONE-OPERATOR STATIONS

Call	Orig.	Del.	Rel.	Extra Del. Credit	Total
K6QGD	216	192	1530	75	2013
W5OW	194	540	580	—	1314
W6NGG	511	160	—	160	831
K6NXD	350	67	100	61	578
W3USA	—	—	520	—	520

These stations "make" the B.P.L. with total of 500 or over. One hundred deliveries + Ex. Del. Credits also rate B.P.L. standing. The following one-operator stations make the B.P.L. on deliveries. Deliveries count!

W6OBJ, 420	W6NLK, 110	W6BQO, 102
W61BB, 215	W7BQC, 110	More-than-one-opr.
W6JTY, 213	W7WZB, 110	W5FSK, 148
W8GUF, 169	W2PF, 107	

A. A. R. S.

Call	Orig.	Del.	Rel.	Extra Del. Credit	Total
WLMC (W3DQN)	22	64	466	52	604
WLMI (W6GXN)	78	185	340	—	603

MORE-THAN-ONE-OPERATOR STATIONS

Call	Orig.	Del.	Rel.	Extra Del. Credit	Total
WLMC (W3CXL)	142	102	705	—	949
A total of 500 or more, or 100 deliveries Ex. D. Cr. will put you in line for a place in the B.P.L.					

received permit from Bu. of Posts to operate same under my initials FE. Transmitter consisted of large brass key, small spark coil, photoplate condenser, straight spark gap and helix. Receiver used crystal det. and loose-coupler. 1919—On air after the War, same rig with addition of audion; cabinet using audiotron and W.E. VT-1 tubes. 1921—Licensed in San Rafael, Calif., with call 6ANM. Transmitter 1-kw. spark using Acme transf., Murdock kickback preventer, Benwood rotary quenched gap, Acme oil dielectric condenser, and Thordarson O.T., Clapp-Eastham "Boston" key used. Also C.E. "Quick-change aerial switch." Receiver: long wave with honeycomb coils, short wave (200-1000 meters) regenerative using variometers. Two stages of audio and Magnavox speaker. Maximum DX: 500 miles. Have kept on the air steadily through the years although I have moved around quite a bit. Have been A.R.R.L. member constantly for past 16 years; my proudest possession is my complete file of all copies of QST. Other calls held include 1ZA (1923), first regularly issued P. I. call; 1XC (also 1923); built Philippine 3AA (1925) and made first contact P. I.-U. S. on 7 Mc. in 1926 using that call; built P. I. portable 1ZA on Model T Ford coupe (1926); took portable 1ZA around the world (1927) and drove same through Europe; operated many well known amateur stations en route, as SS2SE, 11ER, ef8BF, g5AD, etc.; had K3AA on the air again in 1928-1929, then again in 1932 as KA3AA. Later in 1932 became W6GVU in Calif., then again to KA3AA in 1933, and back to W6GVU 1934-35-36. In the spring of 1937 moved to Springfield, Mass., where I am now operating as W1KOM, 7259 kc. In addition to calls mentioned have also operated 6AP (1921), u1MX/u1XM/W1MX/W1BMX (1927-28-29-30-31). In 1925 assisted in construction and first operation at P. I. 1HR." . . . **Anton C. Frey, W2JF**: "Started in radio in April, 1909 at the age of 14, inspired by an article in the 'American Boy' on 'how to build a 300-mile wireless.' Obtained First Grade Comm'l license in January 1913, and by 1914 had operated on two coastwise vessels. Obtained my station license as soon as possible after they were issued, receiving the call 2JF, which has been mine alone ever since. It was issued before the World War and the R.I. reissued it to me after the War. In the early days I was the proud possessor of coherers and auto coherers and with a half-inch spark coil worked 'DX' to tp 5 miles. Hi. The present trans-

mitter uses an 830 in the final with an input of about 55 watts on 14 Mc." . . . **Floyd L. Vanderpoel, W1WR:** "Started in radio in 1901. First call used was FLV, on Spark, New York City, 1908. After the War received call 1HBP, later changed to 1BEP. Still later received W1WR, which am still using on 28-Mc. 'phone and 14-Mc. c.w. In 1932 established 75-mile link on 56 Mc. with W2AMD/W2ZZV, one of the greatest distances spanned along about that time. (See page 25, Dec. '32 QST)." . . . **K. B. Warner, W1EH,** Secretary, A.R.R.L.: "Interest and tinkering with detectors, 1905-1911. First station, 1911, call KBW. First government call, 1913, 9JT. Postwar second operator at IAW, 1919-1920. Other calls held and year received—1KBW, 1920; 1BHW, 1921; W1BHW, 1929; W1EH, 1929." . . .

How about hearing from more of you Old Timers who were licensed 20-or-more-years ago and who still hold amateur tickets? C'mon out of hiding!

Briefs

W8JSU is in the Coast Artillery, B Battery, R.O.T.C. Wouldn't it be like a ham to be in B Battery? —**W3OFO**

There shouldn't be any difficulty in getting a rag chew these days—there are now 1196 active members of the Rag Chewers' Club! Watch for the fellows signing "RCC" and assure yourself of an interesting QSO.

One-act play, by W3QP: Place, any Canal Zone Army Post. Traveler from Alaska to New York by boat walks into the Post food store, hands a small bag of K7 gold dust to the K5 marine back of the counter, and walks out with a K6 pineapple and a bunch of K4 bananas under his arm!

Are you interested in taking part in an A.R.R.L. Traffic Net this coming season? If so, send a postal at once to the Communications Dept., A.R.R.L., West Hartford, Conn., and we'll pass along the dope to the right party. It is expected there will be a net in operation in practically every one of the 70 A.R.R.L. Sections. Get in on the fun.

W4BM gave a talk on amateur radio on the Hobby Hour over broadcast station WSIX, Nashville, Tenn.

Use QTH (not QRA) when giving your location. QRA does not properly express location. QTH means, "What is your position?" or, "My position is" QRA means, "What is the name of your station?" or, "The name of my station is" Surely your city or town is not the name of your station. Use QTH instead of QRA.

Then there are the hams who have "raised Cain" . . . **Master Cain (W4CYC)** to you!

On November 17, 1936, a get-together of radio amateurs who are also Public Service employes was held at Newark, N. J. The following were present: W2EXQ ZB RP HLG AOG AUH BAL BOE CBH FSQ GYY GZG HOJ HIK IGT JAB W3ESJ AYC FBG CCC. These men have a total of 178 years' experience in amateur radio, some having held amateur licenses before the War. Since this original meeting the Public Service Radio Club has been organized, listing in its membership employes of the Electric and Gas or Co-ordinated Transport companies of New Jersey. Their fall dinner will be held in Newark.

For the first time in the 41 years of the National Open Golf Championship amateur radio was used in 1937 to keep newspapermen and spectators informed of the hole-by-hole scores of the 166 contestants. Two sets were installed near the club house and two on the course, one near the second green, the other near the thirteenth tee. The progress of each player was reported to the press tent and the office score board by radio as soon as every three holes were completed. Messengers rushed the scores to the two spots on the course and radio did the rest. The system proved considerably faster than the old messenger system used for 40

years, and amateur radio will probably be used at all future "opens." The amateurs carrying out this work were W8LGP, W8KDR, W8KZU, Joe Marks and Charley Thornton.

Jimmie Long's (W4KB) annual hamfests have become an institution in Florida amateur radio. The "seventh annual" held on the June 19th-20th week-end went over with the usual "bang" with over 100 registered. W4KB is delightfully located at Valparaiso, on the gulf coast surrounded by bays and bayous. Fishing, boating and swimming was enjoyed by many of the gang. The banquet was held Sunday noon. A generous assortment of prizes were awarded. W4MS, the retiring Western Florida S.C.M., thanked the fellows for their help. W4GP, Assistant Director, South-eastern Division, brought official A.R.R.L. greetings. Everybody had an S9 time and Jimmie's reputation for staging real hamfests still holds. The days are already being counted until the next one!

Wanta Work Nevada?

What with the W.A.S. award and all, Nevada is a mighty popular state in amateur radio these days. If you're one of the many who needs Nevada to complete contacts with all states, this will interest you: During the month of September W6HTO is going to operate from a junction monument for the states of Nevada, Arizona and California. He will revolve his rig around this monument, operating in the three states on regular schedules. 1807-kc. 'phone and 3614-kc. c.w. will be used. Starting September 1 and on each successive odd day, operation will be from Nevada, starting at 2:00 A.M. PST, ending at 6:00 A.M. PST. On the even days operation will be from Arizona or California at the same time. W6HTO will also arrange special schedules for 56 and 28 Mc. QSO's between 2 and 6 A.M., PST with any amateurs interested. Address him: C. E. Goar, W6HTO, Box 4, Needles, Calif.

A radiogram from OZ7TI via W8DOD and W8OQF reports that OZ8N is on his way to Greenland as operator with an Arctic expedition. The message reads, "He will start about 10 August with traffic on 20, 40 and 54 meters." Please report reception and contacts OZ8N to A.R.R.L. HQ's for QST mention.

A-1 Operator Club

THE following have been admitted to membership in the A-1 Operator Club since the complete roster was printed in December, 1936 QST:

C.W.—**W1EH EZ GMM IEG JFN JPE JPY W2BST DUP IOP W3EDP EFM EZN GDI GKZ W4BJA DZS TR W5BAM BCW DXA W6GQC KWA LBB W7BSX BVE COH NH W8AXD AXV DPE HMH IAW ICM IKZ LCY MOT QHL WE W9ALI AZR DHN EBX EDI EDQ NNM NNZ OUD PCR (Vi & Vee) PDL POB PVZ SGP TO WAM VE1EX 2DR K6AIU K6COG K6MEG (opr cw) KA1HR K5AG.**

CT3AB D4TKP XCG ES5C FSPK G6NJ 6QX HA3H 8D HB9AD J5CC LUT7F OE7EJ OH5NG OK1BC 2VA ON4DX 4FE OZ8J PA0ZK SM5XW VK2AE 2DA 3EG 6SA VS6AH YM4AA ZL1DI 2BN 4A0.

'PHONE—W3CKD W3MD W8UD.

Changes in December '36 QST listings: W3GY ('phone) was inadvertently omitted from the list. VK3WL, listed as VK2WL in error, is now signing VK5KO. VE3HA is now VE2FJ. W9APY is now W9WR. W9DOU is now W8PNG.

A-1 Operator Club members are constantly on the watch for new members. Nomination by two operators who already "belong" is necessary before any operator is admitted to membership. It is not necessary to be a "speed king" to rate membership among the "A-1 Operators"—you must be an "all-around good operator" with consideration given to general keying, voice technique, procedure, copying ability, judgment and courtesy. The Club is open to all active radio amateurs, both 'phone and c.w., in any country of the world. Make your operating such that it will merit nomination to the A-1 Operator Club!

How's DX?

How:

There are two schools of thought on this QSL-card business. One, supported by many of the old timers who filled their walls years ago, takes the well-known GTH attitude about it, feeling that it can't get hopped up over a fellow's card, and that it doesn't make any difference as long as they worked the guy. (We knew one well-known DX man who was superstitious about the whole thing, and felt that if he ever had any cards printed and acknowledged his contacts his luck would change and he wouldn't be able to bowl them over in his usual style.) The other group collects cards from most of their DX contacts, and gets a major bang out of receiving a card from a new country or swell DX rag-chew. Both schools have their ardent adherents, and it is not our place to say which is the better. The point we want to make, however, is that collecting cards does give you a pretty good idea of what the other fellow was using (or claims he was), and it does prove pretty well that the fellow you worked was not a phoney. And you'll need the cards if you are going to become a member of the DX Century Club, explained elsewhere on this page. Also, it's hard for your rivals to call you a liar about DX when you can produce the cards. . . .

Will someone please tell us why more of the DX gang doesn't use 7 Mc.? We know that 20 has been so hot for the past few years that lots of the boys have bedded-down there, but you're passing up some good stuff by not giving 40 a whirl. For example, W9ZDZ reports hearing a VK9 up there the other day. And don't say that there are too many lids on 40. All it needs is some DX men to get on and show them the DX roll, the "please-come-back" swing, and the "ou-top-of-the-other-guy" swish and shuffle. Then we'll have some operators, or something. . . .

Where:

A new prefix has appeared in the British Isles, and now all stations in Wales use "GW." The rumored "GX" for the Shetland Islands is not so. . . . W3GPR reports working FQ8AB (14,290 kc., T9) at 6:30 p.m. for the French Equatorial African station's first W contact . . . This fellow OY1B (14,440 kc., T5), in the Faroe Islands, looks like a good one. W2GVX, W2GVZ, W4ZZ, and W4DBF report working him . . . F2PX now uses the prefix he should, and signs FP8PX (14,350 kc., T5c). The card goes to Paul Betcheverry, Box 61, St. Pierre de Miquelon . . . K6OVN (7075 kc.) worked by W6JMR, is in Guam . . . This Connecticut summer heat is no fun. It dims the brain, and stuff. Imagine our missing that guy T4TWO last month! In case you missed it too, W1GKM and others call our attention to the fact that T-4-TWO might be the name of a popular song. . . .

When:

Phone has been neglected a little in this column the past few months, so we'll start with a bang by giving you some of W6ITH's latest 'phone contacts: XZ2JB (14,150 kc.), VS8AE (14,370 kc.), OQ5AA (14,065 kc.), VS1AI (14,040 kc.), KAIME (14,150 kc.), CE1AO (14,060 kc.), XU8HW (14,075 kc.), PK4WS (14,050 kc.), J2MI (14,100 kc.) speaks excellent English. VS2AK (14,260 kc.), W1OXDA (14,260 kc.), and K7VA (14,220 kc.). What, no DX? . . . We don't usually use reports from SWL's in this column, and we really hate to start, but Warren Mayes of Maywood, Ill., has some stuff that's worthwhile, and should help out a few struggling DX men. They are all 'phone signals: EA9AH (14,004 kc.), Spanish Morocco, around midnight; PK3GD (14,010 kc.), in the early morning; ZS6AJ (14,100 kc.), ZT2G (14,135 kc.), VK6MW (14,110 kc.), and HR1J (14,050 kc. . . . Worked recently at W2CYS: MX2B (14,340 kc.), ZC6AQ (14,440 kc., T6), XU6SW (14,380 kc., T9x), U8RK (14,274 kc., T8), U4AG (14,435 kc., T8), and a flock of other stuff. ST2LR (14,310 kc.) was heard

. . . . Dave at W9TWC says that OH3NQP (14,000 kc., T9) is a ship in the Atlantic, and also reports working VQ3FAR (14,415 kc., T8), FMSAD (14,300 kc., T8), FT4AG (14,400 kc., T8), PK6HR (14,270 kc., T7), and PK6XR (14,280 kc., T8) . . . W6CIS is in with VP2TG (14,280 kc., T9), VO1Y (14,060 kc., T9), VS2AE (14,050 kc., T9), XU8XQ (14,030 kc., T6), YV5AN (14,115 kc., T7), and J8CD (14,200 kc., T5) . . . CM2AO passes along PK1VX (14,125 kc., T9), XU3HM (14,050 kc., T7), and ST2WF (14,100 kc., T9), on Sunday afternoons . . . W6LEB reports ZP7AC (14,450 kc.), if you're looking for Paraguay . . . Without benefit of frequency, W4DBF flaunts YS1BC, SV1AZ, CT2BO, CN8MS, and TJC1 . . . W3ELG worked EA7PZ (7060 kc., T4) at 9 P.M. . . . ZL2TS advises all W stations that they're missing a bet if they don't watch the low-frequency end of 80 for ZL 'phones. Several of the better W 'phones are being heard almost nightly.

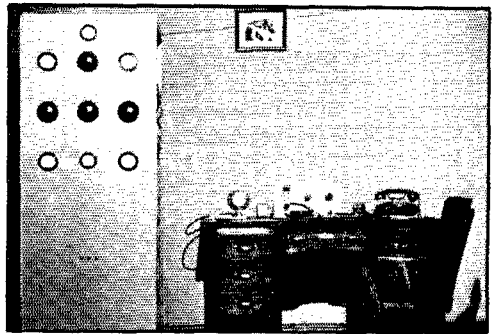

LU7AZ, Buenos Aires, Argentina

If you were in the 1937 DX Contest you know how Camillo Raffo's signal rapped through. An 808 is used in the final with 1 KW input, and a ten-tube super with noise silencer, not shown in the photograph. In case you don't think he gets out, LU7AZ has made WAC with 89 reports on 7, 14, and 28 Mc. He needs only New Mexico for WAS.

What:

W2GVX, summering in the Maine woods, put up a V-beam and likes it so much that it seemed proper to pass along some of his enthusiasm. With approximately 200' on a leg, and an included angle of 60°, the beam has been pouring signals into Europe, bringing back reports of "loudest" and "only" W signal heard. You know, the kind of thing we'd all like to do. VS8AA (14,300 kc., T9c) was worked for the first Asian from the Maine QTH.

A purely personal remark, for which this column will take full responsibility, is that the V-beam is much more practical for the average station than an unterminated rhomboid. Remember, for a rhombic to be a true rhombic it must be properly terminated, and that's not so easy to do. Also, some experience with a diamond shows that the vertical directivity is almost too good for all-around ham work, especially when the leg lengths are long. If you can put up a V-beam, it's probably your best bet for general ham work.

Who:

Fellows we like to hear about are ones like the group of Toronto VE3's who, because the Baffinland station had no facilities, had 500 QSL cards printed for VE5TV and shipped them to him, gratis. Aw, what if there may have been a slight personal motive? . . . The old G-man, W1WV,

is up to 733 different G's worked When someone as far away as VK6SA makes WAS we think he deserves something more than a slight nod of recognition, especially since he beat all the other VK's to it. South Carolina was his toughest state W9UBB sends in a happy thought that G2ZQ had. The English station thinks more hams should go to Reno for their divorces, taking along a portable of course so that more of us could complete WAS. Well, maybe, but Reno would be a good place to stay away from if you want to work a wireless sender OE3AH needs Nevada, Mississippi, Idaho, and Wyoming, for WAS W5FIY has been having fun on 14-Mc. 'phone. For example, he worked VK6WS for a nice rag-chew early one morning and then turned around and had a 20-minute chat with Z58AB. Breakfast was ready when he was through with the ZS but John stood by for one more call. Sure enough, VK6MW came back, but with VK6WS at the mike! It seems that after finishing with W5FIY, VK6WS had hopped in his car and driven seven miles to the shack of VK6MW, to answer FLY's next stand-by. No, we can't figure out why either, but that's the story. Incidentally, however, W5FIY has made WAC on 'phone five times with only 60 watts input, and has had 356 VK QSO's, 16 PK, and 8 KA W6IES has come back hard into the DX racket, and seems to be doing all right for himself. Besides VS8AA, FT4AG, and FB8AB, he lists CR9AC (14 385 kc., T9), J8CF (14,410 kc., T7), PK3MP (14,050 kc, T9), KA1ER (14,300 kc., T9), and KA1AX (high frequency end of 14 Mc., T7), who puts in a good signal with only 4 watts to a 26. W6IES has worked ZL1DA with only 0.9 watts input to his final, but usually runs 600 watts. The low-power stuff was 90 volts at 10 mils to a 35T Speaking of low power, W6CIS says that PK1RL uses only 2 watts input to a 58 oscillator, and a V-beam. We would never have guessed it, the way he comes through on the east coast After some intense research, W5DXA has found that any weak signal you hear calling CQ more than five times without signing has a 100-to-1 chance of being a W.

WAC:

Latest 'phone WAC's are: W9AGO, W4DSY, W4AH, OA4AB, LY1J, W6GRX, FB8AB, XE1BT, VS7RA, W1ADM, VK2JU, W3PC, W2JME, W8ARA, W7AO, K6MVF, LU4BH, PY2GJ, VP2CD, W6JPW, W9LQ, F3JD, PK3GD, PK1ZZ, PK4VR, F3CP, ON4VU and F8DW It seems that Vincent Rosso, W5KC, has the WAC record for the 5th District. On July 11th he worked J2CL, F8WB, G8MY, VK2RA, ZS1AL, W6OMK, and FY8A, in 55 minutes. The rig ends up with an 803 with 250 watts input, and the putter-outer is an 80-meter Zepp.

—W1JPE

56-Mc. DX

THE five-meter band has been performing in grand style the past month or so, and the handful of faithful experimenters down there have been doing some splendid work. Top honors seem to go to W5EHM, of Dallas, Texas, who has been working DX practically every weekend for the past six weeks. By checking signals on 28 Mc., and switching over to 56 Mc. when skip on ten becomes real short, he has managed to work DX in almost every instance. W5EHM, using 150 watts to a pair of T20's and a "J" match vertical antenna, has worked W4, W5, W6, W8, and W9. On one Sunday he worked 22 W8's and W9's in less than an hour! . . . W5DYH, also of Dallas, has worked W8OPO, W8VB, and W9ZMG, and has been heard by W8BAX, W8PGR, W8GU, and several SWL's in Ohio and Illinois. He uses a rotatable Yagi with one director and one reflector . . . W5FVE, of Dallas, has heard a number of W8's and 9's but has had no luck raising them so far . . . In Detroit, W8AZZ, W8VB and W8LZN, have worked W5EHM and heard W5DYH. W8NOB and W8IFE have heard W5DYH . . . In Milwaukee, W9JTR has heard W2GPS, W5EHM, and an unidentified W1, and adds that W9SLF, W9SO, W9YMG, and W9SYT have worked W5EHM . . . In Pittsburgh, W8QXO has worked W5EHM . . . W2JAX in Schenectady has been heard by W9YGG and W9YMG at Milwau-

kee . . . Frank Koval in Cincinnati, Ohio, has heard W5EHM while the Dallas station was QSO W8YBF and W8QXO . . . W9OLN has heard an unidentified W3 . . . W1EHT, portable at Peterborough, N. H., was heard by W9YGG, Milwaukee.

These scattered reports clearly indicate that 5-meter DX has only started, and that with a little smarter operating and more frequent listening the many active 56-Mc. amateurs should be able to take advantage of the good conditions. There seems to be no set time when the band will open up, since the signals have been getting through to the Fifth District any time between 11 A.M. and 8:30 P.M. Close checking of conditions on 10, plus the use of rotatable beams and stable signals, should result in many more contacts.

AND PLEASE LET US KNOW OF ALL DX CONTACTS ON 56 MC! The information is invaluable, not only to let the rest of the gang know what is happening but because it may lead to some correlation with conditions on other frequencies.

CANADA MARITIME DIVISION

MARITIME—SCM, A. M. Crowell, VE1DQ—Nova Scotia: Extra! The Maritime Division A.R.R.L. Convention will be held at the Lord Nelson Hotel, Halifax, on Sept. 4th, 5th and 6th. An exceptionally fine program has been arranged. Two-fifty covers the entire show, one dollar for YL's. Make reservations now from the Halifax Amateur Radio Club, Room 50, Y.M.C.A., Halifax. FQ has been doing a nice bit of 14-Mc. 'phone DX. EK works the usual run on 14-Mc. 'phone and c.w. FO is busy with ham-fest arrangements. GL has been transferred to Moncton. GR alternates between 14 and 3.9-Mc. 'phone. MP is on 3.9-Mc. 'phone. DQ has the new rig on the air in new shack. BC sports a new NC101X. W4BBV visited the S.C.M. and spent a night on the air with DQ. JK recently visited the Halifax gang. KJ has new five-foot rack finished and ready to hit the air. EA got himself a YF. Congrats, OM. LT is working portable about a half mile from Annapolis Royal on 3.5 and 7 Mc. for the summer. Moncton news via EV: DC will soon have new RME and DB20 going. IJ is building new final. EL is perking on 14 Mc. JU moved to new QTH. LP is going on 3.5 Mc. with Hartley '45. GS is building a 6L6 crystal oscillator. GI is completing new skyhook. EV had an enjoyable visit from W2JMH. BB ruined his 3.5-Mc. crystal with 6L6 oscillator. The M.A.R.C. operated portable in the Field Day at the Moncton Airport. L.C.A.R.C. news from St. John via EE: AK had his license renewed. JN, GP, GQ, IZ and BM are keeping 56 Mc. hot. GQ and his YL expect to take the plunge soon. EE has a fine 5-tube 56-Mc. transmitter and receiver mounted in the car with a directional antenna. KZ had license endorsed for unlimited 'phone. The Loyalist City Amateur Radio Club held a successful Field Day. FL met his YL thru amateur radio. GP is putting a fine signal across the pond with new antenna. VO1A has the O.P.S. for Curling, Nfld.

ONTARIO DIVISION

ONTARIO—SCM, Fred H. B. Saxon, VE3SG—R.M.'s: 3ABW, 3DU, 3GT, 3MB, 3QK, 3TM, 3WK, 3WX. P.A.M.: 3NX. GONE WITH THE WIND—one entire antenna system, during an electrical storm. GR's antenna was grounded, so the only loss was the antenna itself, except for a few QSL cards which were scorched by the flash. See that YOUR antenna is grounded and save a lot of grief. Nineteen members of the North Toronto Club motored to Bowmansville and visited CRCT. W1JPJ is now living in Toronto. Welcome to the Section, Bud. W8CKU, his wife and friends visited SG. ZQ is operating 9DT at Red Lake for O.F.B. The Brantford Club held a very successful picnic at Mohawk Park, which was attended by hams from Toronto, Hamilton, Galt, Chatham and Guelph. The last prize drawn was an old home-made variable condenser, and SG, who got it, is wondering if Alexander Graham Bell had anything to do with it. AMX (Toronto) is at Grimsby Beach for

(Continued on page 100)



CORRESPONDENCE

The Publishers of QST assume no responsibility for statements made herein by correspondents

"But It Never Could Happen To Me"

60 Carey Ave., Butler, N. J.

Editor, QST:

Mr. L. R. Mitchell's article in the August issue of QST, "But It Never Could Happen To Me," prompted me to write this.

Within the past few weeks with the cooperation of Mr. Martin Peterson, W3GQG, I succeeded in locating four bootleg stations, all within a radius of five miles. After the location and identity of the stations and owners were established, I immediately got in touch with the F.C.C. I made an appointment with the inspectors and turned over all data to them with the result that the bootleggers were summoned to the office of the F.C.C. They spent a very unpleasant four hours explaining why and how they were operating an unlicensed station. It is satisfying to know that the stations are off the air, and for the benefit of the fellows whose calls were being bootlegged and kicked around by a bunch of nit-witted would-be operators, and in case they may receive "QSL" cards and don't know where they originated, the bootleg stations were using the following calls: W2DIE, W2JFX, W3FWO, and W3GQY, also a first district call that I was unable to learn.

Information was obtained from a very reliable source that the bootleg stations in question had been warned by members of a radio club, but instead of taking a friendly tip it was their boast that they would never be caught and that they were making suckers out of some of the amateurs. One of the bootleg stations was using a first district call on five meters and had some of the boys pretty well elated, thinking they had worked W1 on five. After learning this I decided to grab myself an earful of five meters occasionally and see what was what. It didn't take long and "before it happened to me" I contacted the F.C.C.

I believe in giving any youngster a break in getting started on the right track and becoming a "ham," as I will never forget the kick I received with my first loose coupler and crystal detector and the thrill that came with making a "helix" and condensers (from tin foil taken from Fleischman's Yeast Cakes), as well as the old coffin, the straight and rotary gaps, etc. I was then 2ARX. My shack is always open to any would-be amateur and I believe this should be the policy of every ham when a newcomer has a *legitimate interest* in radio, in an effort to get them started on the right track.

However, starting with the four stations already turned in to the F.C.C. it will be my policy from now on to make an immediate report without any warning to the bootlegger causing the offense. I am intensely interested in Mr. Mitchell's movement in starting a club whereby the evil of bootlegging can be checked and abolished, and there is no reason why it cannot be if licensed amateurs would apply themselves and help make amateur bands for amateur use only.

—Frank A. Kelly, W3CKY

EDITOR'S NOTE.—It is simply a matter of self-protection for every licensed amateur to aid in curbing any illegal operation that may come to his knowledge. From the standpoint of the licensed amateur there can be no difference between the bootlegger who endangers amateur radio's prestige and privileges and the burglar who would rob his home. One may attempt to reform the violator, but there should be no condoning of his crimes.

Radio in Spain

London, England

Editor, QST:

The start of the Spanish radio trouble can be placed in the final week of July, 1936. My news editor telephoned me one Sunday after lunch to say that civil war had broken out, all communication with Spain was interrupted, and asked if I could get any news via radio.

Until 6 o'clock nothing transpired, and then the Spanish commercials started up with V's, finally sending press to Vienna, Brussels, and Monte Grande. One ham was contacted, but he didn't even know that war had broken out!

Next week a conference was held at the paper office. I pointed out that although Spain had a number of medium-wave broadcast stations, at that time (midsummer), as their power was relatively low, they would not be received well in England. Further, Madrid had control of the only real international station, EAQ, on 31 meters, so the rebels would have to take steps to combat the propaganda. To get uncensored news out of the country would mean the use of portable h.f. gear, and I advocated shipping some over (AP soon did it). It was obvious to us all that EAQ would result in some counter effort by the rebels, and that as the amateurs were the main possessors of

shortwave gear, it would only be a matter of time before this was confiscated and turned to propaganda use. It was decided that a watch should be maintained on all bands. I was in charge of this watch. An interpreter was provided, who had a knowledge of all Spanish dialects.

The first few weeks were comparatively uneventful, most of the dope coming over EAQ and Moscow. On the broadcast band, "Seville" was rebel and "Madrid" government. Both these stations were supposed to be on the same frequency, 731 kc., but as they drifted 400 cycles apart, it was just possible to separate them, using a xtal Comet Pro and a xtal Super-Pro in diversity. Seville was the most interesting, speeches by General Queipo de Llano, in which he threatened government territory with what he would do to the inhabitants if they didn't submit to him, being the daily menu.

The international propaganda of EAQ soon met with a counter attack from the rebels, who obtained control of the station of the Radio Club of Teneriffe, on about 29 meters. These two stations are still the only two really large short-wave ones used.

Within a month amateur gear was being used. At first this was used for what the operators termed (in Spanish) "Succour Service." A ham in rebel HQ, Tetuan, would call government Madrid, "Atencion Madrid, Atencion Madrid . . . A qui Tetuan, a qui Tetuan." He would then state that he was part of the amateur succour service, and would, for example, read out the name of a man a dozen times. Then he would say, "Please tell his wife X, in Y Street, Madrid, that he is safe at B hotel Tetuan." He would read through a long list of names in this fashion, sometimes stating that they were dead or wounded.

Notices would be given out about food rationing, train services, hospitals, the calling up of certain sections of the militia, etc. The great feature of the "Succour Service" was that government and rebel situated hams used to contact each other.

The only real ham station using its call was EAIBU, Corrunna, but in spite of repeated attempts, "Ay Ah Oona Bay Ooh" wouldn't QSO me! The remainder only announced the name of their town, "A qui Oriedo," etc.

Gradually the hams have been taken over for pure propaganda use. At the present time the entire 7-Mc. band is filled with them. Their power has obviously been increased, speeches are broadcast in Spanish, news in English, French and German, while the intervals are filled with broadcast music.

At one swing of the dial I have counted 42 different Spanish stations on the 7-Mc. band, all 89 max. After dark it is absolutely impossible to contact any but very local stations owing to the terrific QRM. Such is the present state of the 7-Mc. band in Europe.

—Newspaperman

EDITOR'S NOTE.—Although it is *QST's* rigid policy not to print anonymous communications, the above letter is of such general interest that, at his request, the name of the writer, a well-known English amateur employed by one of London's most famous dailies, is withheld.

Let us now be deluged by letters from partisans of either cause for having published this impartial report on radio conditions in the Spanish civil war, we repeat that the policy of *QST* is to publish all the radio news but to keep out of politics.

W-9-SWL? F.C.C. Says No

EDITOR'S NOTE.—Recently several correspondents have written the League inquiring concerning the use of such designations as "W9SWL," etc., on QSL cards, to designate short-wave listeners. The following, taken from a letter written by the Commission in response to such an inquiry clarifies the point:

Federal Communications Commission,
Washington

Replying to your letter of June 9, you can find information regarding radio call letters in treaty, statute, regulation and

related literature, but such calls are to identify transmitting stations.

There is no occasion to assign call letters to receivers that may neither call nor be called. In this light, the expression "SWL calls" is a misnomer, a contradiction of terms.

By use of call letters a transmitting station may aid identification, but this frequency requires reference to call lists for details. Short-wave listeners wishing to print identifying cards are under no such handicap since they can at once print the details, including names, locations, etc.

—T. J. Slowie,
Secretary

Sub-Harmonics

Florence, Italy

Editor, *QST*:

Many thanks for the publication of my letter about sub-harmonic reception in May *QST*. It was with great pleasure I received some correspondence and inquiries from other experimenters interested in the phenomenon I described. I feel disappointed, however, to see there is in our circles a tendency to misuse the word "sub-harmonic." Many hams in fact confuse ordinary reception of harmonics (viz., frequencies higher than the fundamental) with the second type of reception or sub-harmonic (viz., frequencies lower than, or submultiples of, the fundamental). The first is a well known fact usually due to insufficient flywheel effect in the plate circuits of our r.f. amplifiers whilst it was to the second fact not yet well known I wanted to attract the general attention. In confirmation thereof I will mention the interesting letter of D4MDN published in June *QST*. In this letter there are many citations of sub-harmonic receptions which evidently were ordinary harmonics or multiple frequencies as explained above.

I hope such a confusion will no more occur and I have written this letter to you in order to have the problem to be solved well in the clear.

—Pier Luigi Barbellini, I1KS

Skip on U.H.F.

Jerome, Ariz.

Editor, *QST*:

I have noticed an effect that may be of help to those experimenting on the ultra-high frequencies.

First: On the several nights that I have found these bands "open" I have noticed that 20 meters will have a very short skip, that 10 meters will be open but that the skip will be greater, that 5 meters will be working with a skip of at least 1000 miles, while on such nights I have heard weak signals on the 2½-meter band. From this I feel that the frequencies (so far no limit has been found) have a skip characteristic such that, when the signal returns to earth, the skip is inversely proportional to the frequency used. So far I have found no set character of the reappearance of these nights. Such effects have not been noticed in daytime. The usual time at night is from 9:00 p.m. to about 11:00 p.m. or midnight (local time).

Second, on days when the skip (daytime) is very short on the 10-meter band, often being 500 miles or less, the 5-meter band will also be working, and skips as short as 900 miles have been noted.

—Richard T. Sampson, W60FV

The Habana Conference

White Bear Lake, Minn.

Editor, *QST*:

I have just received two documents from the F.C.C.—No. 20769, Final Minutes of the Regional Radio Conference (Habana, March, 1937), and No. 20781, the Report of the American Delegation to the Conference.

(Continued on page 70)

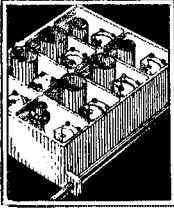

SEVERAL months ago in this space we admitted that a new receiver to fill the place once taken by the FB-7 was being designed by Dana Bacon and his staff. The receiver is now in production. Elsewhere in this issue of *QST* there is a preprint of a page from the new catalogue that describes its major features. However, readers of this page have become accustomed to an unusually frank discussion of new products, and we will try to live up to expectations.

Most amateurs do not need to be told that when a communication receiver is to be sold for as low a price as the NC-80X it is necessary to make compromises. These compromises can consist either of cutting quality by using cheaper parts, or of simplifying the chassis by eliminating everything not absolutely necessary. In the case of the NC-80X the latter course was followed. Possibly some of the features left out are ones that you would like to have, but the pruning has been done very carefully, and we think you will find that the NC-80X is a thoroughly capable receiver in actual use.

The principal economy in the NC-80X is the elimination of the preselector. The reason for its elimination is because a cheap preselector is no darn good, while a good preselector costs too much. However, the problem cannot be dismissed as easily as all that, and some provision must be made to insure good image suppression and adequate signal-to-noise ratio. In the case of the NC-80X the solution lies partly in the use of a high IF frequency (1560 KC) which results in having the image frequencies removed by 3120 KC. With the image as far away as this the signal-to-image ratio is adequate even with only the one tuned RF circuit. As a matter of fact, image suppression is better than on many receivers with very elaborate preselectors.

The high IF frequency does not of itself improve the signal-to-noise ratio, but it does help by making possible the use of a new crystal filter. This filter has continuously variable selectivity from 300 cycles to 7 kilocycles and is left in circuit continuously. By operating with optimum selectivity, the noise can be reduced sufficiently to make the signal-to-noise ratio fairly good (cw noise equivalent approximately $.3\mu\text{v}$). As we remarked before, the NC-80X is a thoroughly capable receiver in actual use.

Generally speaking, the NC-80X is a simplified version of the NC-100X and like it employs the movable coil tuning unit which has proved so successful. However, unlike the NC-100X, it has an AC-DC power supply. Aside from the obvious advantage of versatility and low cost, such a power supply has a number of advantages. For one thing, the absence of the power transformer makes the set run much cooler. For another, regulation is much better so that any possible detuning effect from adjustment of the RF Gain is reduced by ten to one. The principal objection to AC-DC packs in the past has been that only low audio output was feasible with such a low plate voltage. However, the new beam amplifiers give two watts, which is ample.

Of course, the schemes described above are mostly only devices to make it possible to build a good receiver at a low price, and we are the first to admit it. There is no complete substitute for a good preselector. If you insist on one, the NC-100X has a good one, and the HRO has a superb one. But if you want to be thrifty, we think you will find the NC-80X a very fine compromise design. After all, we have no house of magic here; we have to depend on adroit engineering.

JAMES MILLEN



Use
YAXLEY
 APPROVED RADIO
 PRECISION PRODUCTS

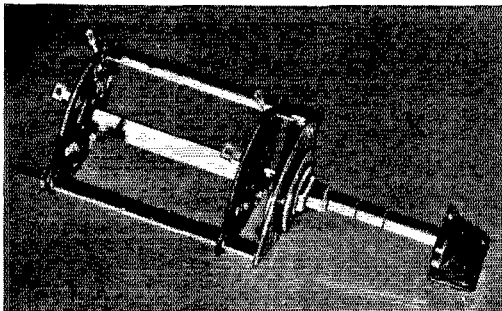

YAXLEY

Hamswitch No. 151L

Designed to effect economy and convenience, the Yaxley Hamswitch No. 151L permits the use of a single meter to measure the currents or voltages on up to, and including, five circuits in an amateur transmitter.

The Yaxley Hamswitch No. 151L replaces the awkward dangling cord and plug—insures an accurate meter reading since the proper shunt or series resistor is permanently connected in the circuit.

Double-spaced contacts and high grade insulating material permit a conservative rating of 1500 Volts, D.C., or 1000 Volts R.M.S., A.C. The Yaxley Hamswitch No. 151L is fitted with an adjustable stop so that fewer positions can be used if desired.

See the Hamswitch at your distributor's.

P. R. MALLORY & CO., Inc.
 INDIANAPOLIS INDIANA
 Cable Address—PELMALLO

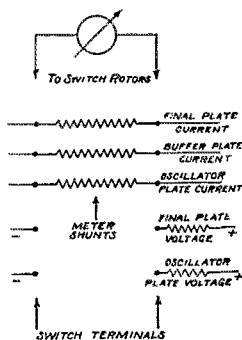

(Continued from page 68)

After some study, and discussion with fellow hams, I have come to the conclusion that Article No. 7—"That the 40-meter amateur band be sub-divided into two parts: one from 7000 to 7100 kc. exclusive for radiotelephony amongst the Latin-American amateurs, and the other, from 7100 to 7300 kc. remain as before, only as a radiotelegraph band"—is designed to remove 100 kc. from the amateur's over-worked 40-meter band. I base my opinion on the word "exclusive" which I underscored above. The recommendation as passed, regardless of intent, excludes all c.w. and U. S. stations from 7000 to 7100 kc.

We, the U. S. and Canadian amateurs have been assured by A.R.R.L. and QST that such was not the case. Can you, publicly in QST, quote the above recommendation and explain how you know that the U. S. and Canadian hams will be allowed further use of those 100 kc. when this recommendation becomes an international agreement? I may be dumb or something, but I don't see how that word "exclusive" can mean anything else, but you may be able to set me straight. I asked the F.C.C. and they just quoted the report.

Also, in the same minutes, I note a table of frequency tolerances, for stations between 1600 and 6000 kc. "authorized by the respective Governments" in which amateurs are not excepted. These tolerances range from 0.1 per cent for mobile to 0.01 per cent for fixed telegraph. While probably not intended to apply to amateurs, by lack of saying anything to the contrary, they automatically do. So us 160 and 180 meter hams must adopt commercial frequency standards. It's a good idea, maybe, but it sure puts a lot of hams in a very awkward, not to say impossible, position.

There is still time to correct these "errors." The F.C.C. and the government delegates to the coming November Pan-American meeting can have the wording of these items changed before their final adoption so that our present rights will be preserved—if we, the amateurs, tell them we want them preserved. If we don't tell them what we want, they assume we don't care, and use our frequency assignments as a means of barter for the commercials and foreign Governments. Maybe we will be like the chair on the uneven floor—they sawed the legs shorter one by one to make it stable, and finally it had no legs at all. Our frequencies are getting shorter and shorter, and still they aren't satisfied with the "fit."

Well, there will be "hams" probably as long as there is a single frequency left for us, but in the meantime let's make ourselves heard in Washington and other centers of radio regulation.

—Harvey R. Pierce, W9OPA

EDITOR'S NOTE.—The proposal concerning the 7-Mc. band is exclusively for the Latin-American countries. It does not apply to the U. S. and Canada. We think our correspondent puts the emphasis in the wrong place. No such arrangement would exclude W and VE amateurs from the use of such frequencies for c.w.

Amateurs are not included in the tolerance table, which deals with specified services such as mobile and fixed, with no reference to amateurs. There is no tacit inclusion of amateurs, as W9OPA suggests.

A.R.R.L. has close liaison with the F.C.C. on this subject, and will be represented in Habana during the November conference. It is by no means assured that the Cuban phone proposal will be adopted. Amateurs may be assured that neither the northern governments nor the A.R.R.L. have any intention of accepting an arrangement that reduces the rights of W/VE amateurs.

Again we encounter the perennial fiction that amateur radio has experienced a succession of losses in frequency assignments. Again we repeat the truth: In the twenty-five years in which U. S. radio has been federally regulated, amateurs have received three increases in territory, one reduction (in 1927). The familiar phrase, "a series of losses," has no basis in fact.

Attention: W8AWI and W6CQP

3435 Sunnyside Ave., Chicago, Ill.

Editor, QST:

... Will anyone knowing the whereabouts of Christy McKee, W8AWI, please communicate his address to his parents, Mr. and Mrs. A. V. McKee, Bangor, Michigan. He was last heard of at Fort Chicago, Calif., almost a year

(Continued on page 74)

Use
 P. R. MALLORY & CO. Inc.
MALLORY
 APPROVED RADIO
 PRECISION PRODUCTS

NEW CONDENSERS *by Johnson*

Smaller Models, with Big Condenser Performance

★ You've wanted smaller condensers that could really take a beating — real small-size transmitting condensers with "big condenser" performance. Now you can have them — with all the advantages of famous Johnson design and construction — in models suitable for every low and medium-power transmitter application — at surprisingly low cost.

TYPES "E" AND "F"

The new types "E" and "F" condensers, though small and compact, are *not* redesigned receiving condensers. They are really new advanced models designed and built for highest efficiency and dependability in transmitting circuits, and have many important features formerly found only in larger condensers.

Small Size: Panel space for type "F" only 2" square; for type "E", $2\frac{5}{8}$ " square.

High Ratings: Voltage ratings to 4,500. Plate spacings: .045", .075" and .125"

Insulation: Ultra low-loss Alsimag 196*

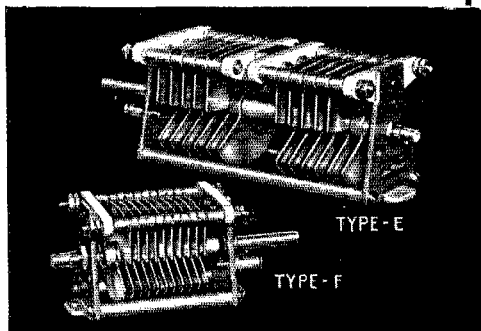

Precision Construction: Sturdy, rigid, yet light, aluminum frames. Positive wiping spring-contact rotor brushes. Rounded-edge polished plates. Chassis or panel mounting. Stator placed above for minimum capacity to chassis. Shaft extensions front and rear for ganging.

You'll be surprised at the extremely low cost of types "E" and "F" condensers!

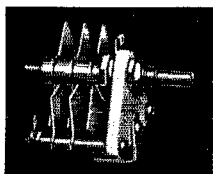

TYPE "G" FOR U.H.F. APPLICATIONS

For transmitter tuning and neutralizing, and for receiver construction, the new type "G" ultra-high-frequency condensers do the job *right!* Lowest possible minimum capacity and extremely low losses are achieved through the use of a single end plate of Alsimag 196*. Mounts direct on panel without additional insulation. Has rotor locking device. Shaft extensions front and rear for ganging. Available in capacities from 8 to 50 mmf. and spacings of .045", .125" and .225".

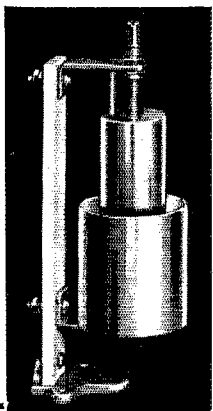

TYPE "N" FOR NEUTRALIZING

These new "concentric-type" neutralizing condensers are ideal for neutralizing high-voltage "low-C" tubes. "Micrometer" screw makes precision settings easy. Uniformly high breakdown voltage throughout entire range of adjustment. Alsimag 196* insulation. Designed for minimum chassis mounting space. Available in a single wide capacity range — 12 mmf. max., 2.5 mmf. min. — with plate spacings for low and high-power transmitters.

Cat. No.	Spacing	List Price
N125	.125"	\$3.25
N250	.250"	4.50
N375	.375"	6.00

* **ALSIMAG 196.** A new ultra low-loss steatite ceramic insulation, with a loss factor less than one-third that of other steatite materials. Impervious to moisture, and mechanically strong.

Ask your Jobber for complete information or write for Bulletin 963J today!

★
Export Office: 25 Warren St.,
New York. Cable: "SIMONTRICE"

E·F·JOHNSON·COMPANY

MANUFACTURERS OF *Radio Transmitting Equipment*

● W A S E C A · M I N N E S O T A · U · S · A

Say You Saw It in QST — It Identifies You and Helps QST

EXTRA

Newark News

EXTRA

HAMS! SAVE MONEY! BUY AT NEWARK!

**SETS AND PARTS ON EASY TERMS!
STOCK UP NOW AND PAY LATER!
GREATER VALUES THAN EVER BEFORE!
MORE COMPLETE STOCKS!
FASTER SERVICE!**

ORDER NOW

Easy terms on orders for parts, sets and tubes, \$60.00 or more. We have all the new amateur sets as soon as released by manufacturers, on our convenient 6% Credit Plan. No matter what set you want, we can furnish it. All the standard makes in stock for immediate delivery. Before you buy, WRITE US. You'll SAVE MONEY!

NEW 1938 LINE OF THORDARSON TRANSFORMERS

PLATE TRANSFORMERS for Amateurs

Fully shielded — air cooled construction — tapped primaries — porcelain terminals.

No.	DC. Volts	DC. MA.	Size	Net Price
T-16P00	500/600	200	3 3/4" x 4 1/2" x 5"	\$3.88
T-16P01	1000/1250	300	5 3/4" x 7 1/2" x 5"	7.64
T-16P02	1000/1250	500	6 3/4" x 7 1/2" x 5"	12.35
T-16P03	1450/1800	300	6 3/4" x 6 3/4" x 5"	11.17
T-16P04	2000/2500	300	6 3/4" x 8" x 5"	13.67

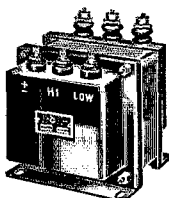

FILAMENT TRANSFORMERS

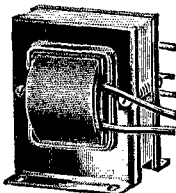

Open style sub or top panel mounting — 115 volt, 60 cycle primaries.

T-16F08	— 2.5 volts C.T. @ 5.25 Amps.	Insulation volts 2,000 \$1.88
T-16F09	— 2.5 volts C.T. @ 10 Amps.	Insulation volts 2,000 \$1.03
T-16F10	— 2.5 volts C.T. @ 10 Amps.	Insulation volts 7,500 \$1.62
T-16F11	— 5.25 volts C.T. @ 4 Amps.	Insulation volts 2,000 \$1.18
T-16F12	— 5.25 volts C.T. @ 13 Amps.	Insulation volts 2,000 \$2.06
T-16F17	— 6.3 volts C.T. @ 3 Amps.	Insulation volts 2,000 \$1.03
T-16F13	— 7.5 volts C.T. @ 4 Amps.	Insulation volts 2,000 \$1.18
T-16F14	— 7.5 volts C.T. @ 8 Amps.	Insulation volts 2,000 \$1.91
T-16F15	— 10 volts C.T. @ 4 Amps.	Insulation volts 2,000 \$1.76
T-16F16	— 10 volts C.T. @ 8 Amps.	Insulation volts 2,000 \$2.35

CHOKES — Input

T-16C20	— 5-20h — 200 ma — 2000 v	Ins. \$2.20
T-16C21	— 5-20h — 300 ma — 3000 v	Ins. \$2.94
T-16C22	— 5-20h — 500 ma — 3000 v	Ins. \$5.29

SMOOTHING

T-16C25	— 12h — 200 ma — 2000 v	Ins. \$2.20
T-16C26	— 12h — 300 ma — 3000 v	Ins. \$2.94
T-16C27	— 12h — 500 ma — 3000 v	Ins. \$5.29

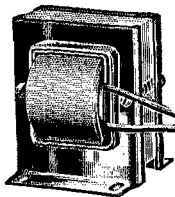

NEW 1938 CHT SERIES

Multi-match modulation with plug-in jack terminals. Completely compound filled.

T-11M74 — Will handle any power tubes to modulate a 20 to 80 Watt Class C Stage. Maximum audio output 40 Watts. 4 1/2" x 4 1/2" x 4 3/4" High. \$4.70
 T-11M75 — Will handle any power tubes to modulate a 40 to 150 Watt Class C Stage. Maximum audio output 75 Watts. 4 1/2" x 5" x 4 3/4" High. \$7.35
 T-11M76 — Will handle any power tubes to modulate a 100 to 250 Watt Class C Stage. Maximum audio output 125 Watts. 5 3/4" x 5 1/2" x 6" High. \$11.47
 T-11M77 — Will handle any power tubes to modulate a 200 to 600 Watt Class C Stage. Maximum audio output 300 Watts. 6 3/4" x 6 3/4" x 7 1/4" High. \$17.64
 T-11M78 — Will handle any power tubes

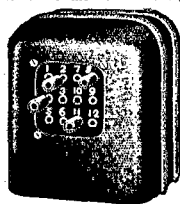

to modulate a 450 Watt to 1 KW. Class C Stage. Maximum audio output 500 Watts. 7 1/4" x 7 3/4" x 8 1/4" High. \$35.28

MULTI-MATCH DRIVER TRANSFORMERS

Plug-in Connectors provide for instant selection of any ratio listed — Recessed sub-base lugs permit single hole sub-panel wiring.

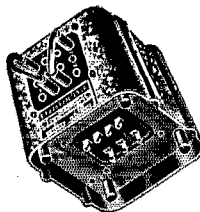

Type No.	Cap. Watts	Mac. Pri. M. A. Per Side	Ratio Pri to 1/2 Sec.	Dimensions W D H	Net Price
T-15D76	15	60	1:1, 1.2:1, 1.4:1, 1.6:1, 1.8:1	4 1/4 x 4 1/2 x 4 1/2	\$4.85
T-15D77	15	60	2:1, 2.2:1, 2.4:1, 2.6:1, 2.8:1	4 1/4 x 4 1/2 x 4 1/2	\$4.85
T-15D78	15	60	3:1, 3.2:1, 3.4:1, 3.6:1, 3.8:1	4 1/4 x 4 1/2 x 4 1/2	\$4.85
T-15D79	15	60	4:1, 4.5:1, 5:1, 5.5:1, 6:1	4 1/4 x 4 1/2 x 4 1/2	\$4.85
T-15D80	30	120	1:1, 1.25:1, 1.5:1, 1.75:1, 2:1	4 3/4 x 5 1/2 x 5	\$6.76
T-15D81	30	120	2.25:1, 2.5:1, 2.75:1, 3:1, 3.25:1	4 3/4 x 5 1/2 x 5	\$6.76

NOTE: The C.H.T. line available in Multi-Volt Plate Transformers, Multi-Volt Power Transformers, Input and Smoothing Chokes, Audio Coupling Transformers, Multi-Volt Filament Transformers, and Multi-Volt Bias Supply Transformers.

Write for Free Thordarson Cat. No. 400A — Just Off the Press.

Send for FREE NEWARK CATALOG!
Contains Everything you need! Write Now!

NEWARK ELECTRIC COMPANY
226 W. MADISON ST. Dept. Q CHICAGO, ILL.

SENSATIONAL RADIO RECEIVER VALUES!

Now You Can Get A Famous New
1938 NATIONAL RECEIVER
 At The Lowest Price in History!

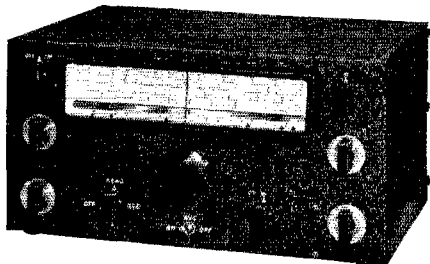

NEW NATIONAL MODEL NC-80X

ONLY
\$88⁰⁰
 Cash Price

ONLY \$18.00 Down
 \$12.68 a Mo. for 6 Mos.
 or \$8.53 a Mo. for 9 Mos.
 or \$6.44 a Mo. for 12 Mos.

(Complete with Tubes, Crystal Filter, 8" P.M. Speaker Chassis)

Ten Tubes . . . 2 Watts Undistorted Output

A New inexpensive receiver that has exceptionally good operating characteristics, Frequency Coverage is Continuous from 550 kc. to 30 mc. The L.F. Amplifier is entirely new in design, operating at a frequency of 1560 kc. The Crystal Filter remains in the circuit at all times. Selectivity is Continuously Variable between 400 cycles for single signal CW and 5 kc. for high quality broadcast.

Many Amazing New Features

The tuning system, likewise entirely new, employs a multiple scale dial of the full-vision type, accurately calibrated in megacycles. Several unusual features are incorporated, such as the mirror for overcoming parallax, the auxiliary linear scale (at the bottom), and the adjustable frequency markers, by means of which any particular stations, or frequencies, such as band limits, may be "logged" on the dial itself. Two vernier reduction ratios are available, 16 and 80 to 1, with a separate knob for each.

MODEL NC-81X — Special Amateur Model Plenty of Band Spread for the Ham!

The NC-81X is a special amateur model having the same features and characteristics of the NC-80X but covers the following bands ONLY: 1.7-2.0 mc., 3.5-4.0 mc., 7.0-7.3 mc., 14.0-14.4 mc. and 28-30 mc. The dial is calibrated in megacycles. Price and payments same as above.

NATIONAL MODEL NC-101X

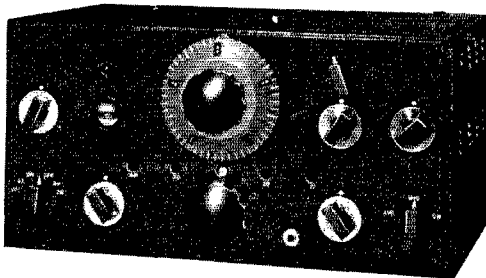

\$129⁰⁰
 Cash Price

Complete with Tubes,
 Crystal and Speaker

ONLY \$24.00 Down
 \$18.58 a Mo. for 6 Mos.
 or \$12.50 a Mo. for 9 Mos.
 or \$9.47 a Mo. for 12 Mos.

Five band spread ranges, 1.7 to 2.0 megacycles, 3.5 to 4.0 megacycles, 7.0 to 7.3 megacycles, 14.0 to 14.4 megacycles, 28.0 to 30.0 megacycles. Automatic plug in coils. Permanent calibration. Micrometer dial. Amplified, delayed A. V. C. Power output 10 watts. C. W. Oscillator. Crystal Filter. Built-in Power Supply. 12 Tubes — 10" Speaker. Our time payment plan makes it easy to own this fine set. See terms listed above.

Other Receivers Available On Time

	Cash	Drawn	6 Months	9 Months	12 Months
	Price	Payment	Payments	Payments	Payments
National NC-100X complete with tubes, crystal and speaker in cabinet	\$147.60	\$27.60	\$21.10	\$14.21	\$10.80
National NC-100 complete with tubes and speaker in cabinet.	\$125.10	\$20.10	\$18.58	\$12.50	\$9.47
National HRO with tubes and coils.	\$179.70	\$29.70	\$26.14	\$17.67	\$13.45
National HRO with tubes, coils and power supply.	\$195.60	\$35.60	\$27.84	\$18.83	\$14.33
Hammarlund Super Pro complete with tubes, crystal and 8" speaker.	\$255.70	\$35.70	\$38.08	\$25.78	\$19.64
AGR-155 complete with tubes and built in speaker.	\$74.50	\$14.50	\$11.00	\$7.39	
AGR-175 complete with tubes, crystal and separate speaker.	\$119.50	\$19.50	\$17.74	\$11.93	\$9.02
AGR-111 complete.	\$189.50	\$39.50	\$26.14	\$17.67	\$13.45
RME-69 complete with tubes, crystal and speaker in cabinet.	\$151.20	\$26.20	\$21.94	\$14.77	\$11.25
Hallcrafters Ultra Skyriders with tubes and crystal. Speaker \$12.00 extra.	\$114.50	\$19.50	\$16.90	\$11.37	\$8.59
New 1938 Hallcrafters Super Sky Rider complete with tubes, crystal and separate speaker.	\$123.00	\$23.00	\$17.74	\$11.93	\$9.02

VERY SPECIAL Oil Filled and Oil Impregnated

FILTER CONDENSERS

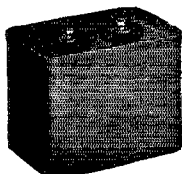

Lucky purchase of 10,000 all well known makes enables us to offer astonishing low prices. All Guaranteed at rated voltages. Already sold down to limited supply and going fast.

Order Now

1 mfd., 2000 V. DC, 5 x 3 1/4 x 1, 1 1/4 lbs.	\$1.25
2 mfd., 2000 V. DC, 4 1/4 x 3 1/4 x 1 1/4, 1 1/4 lbs.	1.50
8 mfd., 2000 V. DC, 5 x 3 1/4 x 3 1/4, 2 1/4 lbs.	2.75
9 mfd., 3000 V. DC, 3 1/4 x 3 1/4 x 11, 9 lbs.	7.25
(Including 2 1/2" Bakelite Standoffs)	
4.4 mfd., 1500 V. DC, 5 x 3 1/4 x 1 3/4, 1 1/4 lbs.	1.75
5 mfd., 1500 V. DC, 3 3/4 x 3 1/4 x 1 1/4, 1 1/4 lbs.	1.90
5.2 mfd., 1500 V. DC, 5 x 3 1/4 x 2 1/4, 2 1/4 lbs.	2.00

NEW TAYLOR TUBES IN STOCK!

T-125 \$13.50; TZ-20 \$2.45; 203-Z \$8.50!

NOTE: For further complete information, items listed on these two pages can be seen in the manufacturer's own ads in this same issue of QST. Send for the Free NEWARK PARTS CATALOG. Contains Everything you Need. Write for it now!

NEWARK ELECTRIC COMPANY

226 W. MADISON ST. Dept. Q CHICAGO, ILL.

... when **QUALITY** counts
CARDWELLS
 ARE USED AND SPECIFIED

Have you noticed:—

- ★ The flock of CARDWELLS in those splendid layouts in Taylor Tubes' new catalog and manual . . .
- ★ UTC's DeLuxe Phone job in the August issue of *QST* . . .
- ★ By Goodman's 56 M.C. Converter in the August issue of *QST* . . . Full of CARDWELL TRIM-AIRS . . .
- ★ The 3 stage All Band Xmitter by Earl Anderson in the June issue of *QST* . . . CARDWELL MIDWAYS at their best . . .
- ★ Harvey Radio Labs., Brookline, Mass., and their new 80-T and UHX-10 transmitters . . . CARDWELLS again . . .
- ★ Gross Radio, New York . . . their economical and well designed kits . . . CARDWELLS for years . . .
- ★ General Transformer's Progressive III and the Streamliner . . . a total of 21 CARDWELLS . . .
- ★ Apparatus built by Collins, Temco, R.E.L., Link . . . and the splendid gear turned out by the largest communication companies such as RCA, GE, Westinghouse, Western Electric, Radio Marine . . .

CARDWELLS ARE ALWAYS IN EVIDENCE

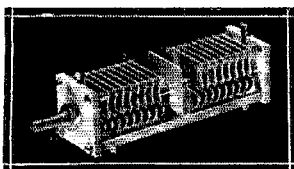

★
**ZT-15-AS
 TRIM-AIR**

3-15 mmf., .070" gap,
 a handy little low
 power neutralizer.

93¢ net

★
**ET-30-AD
 DUAL
 TRIM-AIR**

30-30 mmf., .070" gap,
 showing new heavy end
 plates of Isolantite. Most
 convenient for those 5
 and 10 meter amplifiers.

\$2.16 net

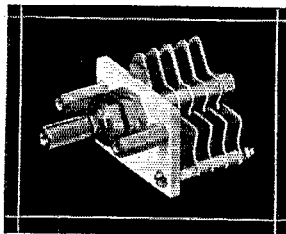

**THE ALLEN D. CARDWELL
 MANUFACTURING CORPORATION**
 83 PROSPECT STREET, BROOKLYN, NEW YORK

(Continued from page 70)

ago. Letters suddenly ceased and his parents are very worried. He simply dropped out of sight, no one having a forwarding address. It is believed that wherever he is he would be in touch with ham radio. If any ham has seen or talked with him, please write the above address and state where and under what circumstances. . . .

—Martin Oberg, W9UGU

Irvington, Calif.

Editor, *QST*:

. . . My OM, A. J. Kiep, W6CQP, disappeared from home, 446 Ashbury St., San Francisco, Calif., on Jan. 30th. I would like to appeal to the radio hams who might know where he is, or to him if he should read this. The junior ops—twins almost seven—are asking about him. . . . They do not seem to realize, and I have not the money to search for him. Of course, the police have been notified, but it's like looking for a needle in a haystack. They do not know him and he isn't a criminal. The radio men constitute a big army—could you print part of this? It is for two children who love their father. Please write the twins, daddy. . . .

—Caroline E. Kiep

Analysis

1502 S. 32nd Ave., Omaha, Nebr.

Editor, *QST*:

As a *QST* addict of 11 years and 8 months venerable record I have digested (often with sadness and disgust) the uninterrupted flow of "suggestions" that monthly grace your pages.

By profession a writer, it has been remarkable that thus far I have held my peace.

My pet annoyists are the "flea-power" paranoids, the "give all the bands to 'phone" egomaniacs, the "cleared frequencies for DX" neuresthenics, the "harmonic relationship" hypochondriacs—and so on through the whole gamut of irrationalists.

Now isn't much of it rather silly? Really—if I were a member of the F.C.C. I should wonder and suspect. In fact, I should seriously consider if a house so divided had any real reason for protection or survival.

Our present regulations are fair, liberal and somewhat satisfactory. We should be damn good and glad we have what we have. In view of the commercial pressure and the ever-widening demand for more radio services, it is nothing short of a miracle that anything remains to us. That's why I often wonder why we persist in digging (yes, digging) the grave of American amateur radio.

It is agreed by leading students of electronics that, barring unforeseen developments, increasing 'phone allocations will be absolutely worthless as far as QRM is concerned. I actually ceased 'phone operation because I became so thoroughly disgusted with the constant propaganda on the 'phone bands for "more frequencies." More frequencies for what? More frequencies to devote to endless hours of illiterate nonsense and unproductive propaganda.

Why don't we face facts? Any engineer will tell you that is properly informed that the number of 'phone stations that might be accommodated in *all* of the present amateur bands is but a drop in the proverbial bucket when compared with the 47,500 licensed amateurs. In connection with my work in the A.A.R.S. and traffic handling I have made a study of copying through QRM. I believe that one 'phone station can effectively block a channel in which ten properly constructed c.w. stations may operate with 100-per cent readability.

"Phones are heading us for severe trouble. My non-amateur friends with popular short-wave receivers are repeatedly asking me questions that I can not answer: "What are they talking about? What use are they? What's the idea? Why should such drivels be permitted by the government? Why can't we have that space for broadcast programs?" and many others. How much is drivels is a question, but one thing is sure: The public is getting interested because they can understand the spoken word. If 'phone men keep up their agitation amateur radio is going to become a public question and when it does we are on our way out.

I wonder just how sensible it is for us to continue a college

WANTED!...

YOUR TOUGHEST POWER RESISTOR JOBS



POWER WIRE WOUNDS

(CEMENT COATED FOR DURABILITY AND PERMANENCE)

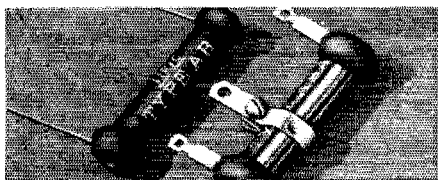

USE THESE "10 WATTERS" UNIVERSALLY

Just the thing to complete a hurry-up service job or whenever you do not have the exact needed range in $\frac{1}{2}$ -, 1- or 2-watt resistors. By moving the contact band of the adjustable unit, any range up to the maximum value may be obtained.

TYPE ABA — 10 Watt Adjustable —

List 60c each

TYPE AB — 10 Watt Fixed — List 40c each.

Made in all practical ranges from 1 ohm to 25,000 ohms inclusive.

Write for Complete IRC Catalog No. 41

THESE IRC Heavy Duty Transmitting Resistors will stand plenty of overload. No break-downs. No opens. No chance of damage by moisture.

For more than five years, IRC Cement Coated Power Wire Wounds have been proving their superiority in every important mechanical and electrical characteristic. You will find them specified for the most difficult industrial, aircraft, naval and communications applications — jobs where resistors *must* stand up at all times under the most exacting conditions of use.

INTERNATIONAL RESISTANCE COMPANY

401 NORTH BROAD STREET, PHILADELPHIA, PA.

Factories or Licensees in Canada, England, France, Germany, Italy, Denmark and Australia

MAKERS OF RESISTANCE UNITS OF MORE TYPES, IN MORE SHAPES, FOR MORE APPLICATIONS THAN ANY OTHER MANUFACTURER IN THE WORLD

RAYTHEON "BEAM" TUBES

HIGHEST EFFICIENCY
LOWEST DRIVER REQUIREMENTS

Raytheon, Pioneers in Amateur Tube Development, Announce Two New Tubes Incorporating the "Beam" Principle.

TYPE RK-47

Hard Glass Bulb. 10 Volt, 3.25 Amp. Filament. 1250 Volts Plate. Driving Power, 1 Watt. Output Power, 120 Watts.

Amateur Net Price \$17.50

TYPE RK-48

Hard Glass Bulb. 10 Volt, 5 Amp. Filament. 2000 Volts Plate. Driving Power 1.2 Watts. Output Power, 250 Watts.

Amateur Net Price . \$27.50

No development since the RK-20 has brought so much to Amateur Radio. Suitable for straight plate modulation, the RK-47 and RK-48 provide the ideal combination of simplicity and economy. Neutralization is not required.

Write for full technical data.

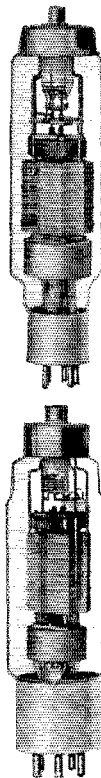

RAYTHEON PRODUCTION CORPORATION

55 Chapel Street . . . Newton, Mass.
420 Lexington Avenue, New York, N. Y.
445 Lake Shore Drive, Chicago, Illinois
415 Peachtree Street, N. E., Atlanta, Ga.
555 Howard Street, San Francisco, Cal.

of bickering that will eventually graduate us out into the cold world of another hobby? I suggest we keep our problems and our misunderstandings off the air—and off paper. The public's interest in our affairs forbodes destruction—and ten years will do the trick unless we mend our ways.

Shall power be limited? I have operated on c.w. and 'phone at least three periods a week for four consecutive years. My power has never exceeded 100 watts. With all the QRM only 9 percent of my calls have been fruitless, only 10 percent have been uncompleted QSOs. This includes, by the way, some nice DX. If we recommend reductions in power to the F.C.C. this precludes more stringent regulations in this and other directions, some less welcome I assure you.

Harmonic relationships? Is it as important as it sounds? Is it worth tampering with our bands, reallocating commercial frequencies, creating all the inquiry necessary to make such changes? I'll buy a couple more crystals, put up with a less efficient (maybe) all-band antenna and let things ride as they are.

Cleared frequencies for DX? It would be nice, of course. But it brings international consequences, more red-tape, more regulations, more inquiry into our status here and abroad. Unless you are a regular lunatic on DX you can work a sizeable amount year in and year out on the seasonal high frequency bands.

We seem to have two hobbies—amateur radio and "crabbing." Are we perilously overworking the latter?

Like other publicly enfranchised services, radio allotments will (in the end) be made only on the basis of usefulness to the public good. Our communication service (amateur or otherwise) will stand only so long as it is useful. Here's a tip to a few thousand crabbing and jabbering amateur radio experts: Join the Army Amateur Radio System or the Naval Communications Reserve. Of course, that means you will have to transmit and receive the Continental code (a stranger to many of our amateurs these days) at the rate of 15 words a minute. You may have to keep schedules—handle a few messages—cut out a pleasant evening sending CQ—but unless you do you just won't have any mike to grumble into for "highs" and "lows," you won't have any short-wave listener public to amuse, and no modulator to adjust for hours at a time whether Class A, B, C or X!

Are the c.w. men the innocent, intending angels that they are painted? Not so you can notice it! You'll find faults in them—thousands of them. They are less known to the public (and therefore less harmful), but they are first class annoyances just the same. There's the "CQers," the power company's friend; the "TNX FR RPT QRU CUL 73" pains-in-the-neck; the "buzz-saws," the "ripple specialists," the "warblers" and the "testers."

Although age is not a prerequisite to amateur radio status it seems to me that the Intelligence Quotient (IQ) and not regulation is the answer to the abuses within our bands. Take a listen (if you can stand it) to the 'phone and c.w. bands on a quiet weekend. What marvels of gentlemanly conversation and edifying information will greet your ear! Grade school vernacular on a public rampage.

Why can't we study our art—advance our particular culture—quietly? Do we have to shout and hicker to high heaven? Peace—the freedom to squirm through our beloved QRM—to enjoy the thrill and the "up" that comes from a triumph over obstacles. Who wants a clear channel? I don't! When I do I'll take a commercial examination and go to work playing nursemaid to a broadcast transmitter.

If we want problems to solve, here's one:

Frankly, our most insidious enemies are the South American and Mexican beam antenna 'phone brethren that politely smother the 20-meter band from 14,000 to 14,400 kilocycles, and enjoy huge chunks of the 40-meter allocation for local (and otherwise) chin-chins. They have a clear channel—and actually kill off more DX than the Dixie Squinch Owl can identify—call pirates—which is fast work, no fooling. Need I dignify these gentlemen by mentioning their calls? It isn't necessary. Everyone from Florida to Alaska knows them well, particularly the c.w. men looking for a contact through the tropical bubbling of the T9x (?) uninterrupted carrier. (Do they actually put interrupters in their high voltage to get that nice bubble in the carrier wave?) It would be just dandy to live in Mexico, or Cuba, or South America. Then you could just plow through the ether as freely as anything. Of course, they wouldn't like to hear this criticism. It isn't cricket. They are allowed to use these portions of the bands for 'phone work. But (please, Mr. Editor) let me just get in these few lines for the thousands of inarticulate American amateurs that suffer in sportsman-like silence.

NEW SOCKETS

The new National Sockets are *completely* new. Contacts have been specially designed for use with ceramic insulation. They extend up into the body of the socket, and grip the whole length of the tube prong firmly. No metal extends through to the face of the socket, and accidental false con-

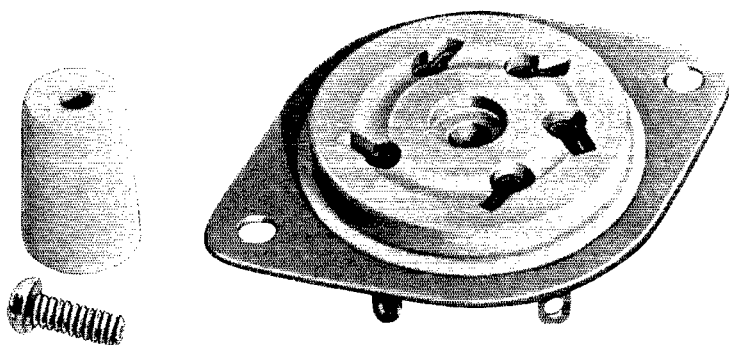

nections can not be made. Wiring to the socket will not break off and go adrift for the terminals do not twist and wobble, yet they are free to float slightly. For beneath-the-chassis mounting, the Isolantite body is clamped securely in place by a metal plate. It can be rotated in the metal holder to any one of six positions for easiest wiring, yet when mounted it is locked in place by keyways. Any socket except the octal may also be mounted

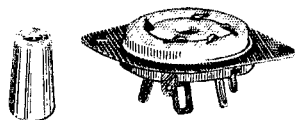

on a single stand-off insulator for above-chassis use. A special Isolantite standoff for this use is supplied with each socket free of charge. Needless to say, this standoff has hundreds of uses when not required for its intended purpose. Two standard metal mounting pillars are furnished with the octal socket instead of the single Isolantite standoff. The new National Sockets are available in 4, 5, 6, 7L, 7S and octal types.

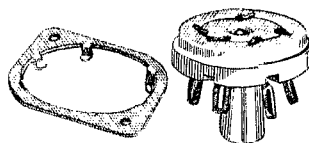

BY NATIONAL

Say You Saw It in *QST* — It Identifies You and Helps *QST*

Use
P. R. MALLORY & CO. Inc.
MALLORY
 APPROVED RADIO
 PRECISION PRODUCTS

For Radio Transmitters

P. A. Systems

Scientific Apparatus

The New

P. R. MALLORY & CO. Inc.
MALLORY
VIBRAPACK

Gives Perfect Portable Power

Inexpensive—Dependable—Compact—and easy to use! At last! An ideal source of plate voltage where commercial electric power is not available.

The Mallory Vibrapack operates from a 6 volt storage battery—provides outputs of up to 300 volts at 100 m. a. of easily filtered DC. In addition, the low voltage models are ideal for converting 110 volt receivers for 6 volt battery operation.

Made in the following models,—

Type	Nominal Output Voltage
551—Self-Rectifying	125-150-175-200
552—Self-Rectifying	225-250-275-300
553—Tube Rectifier	125-150-175-200
554—Tube Rectifier	225-250-275-300

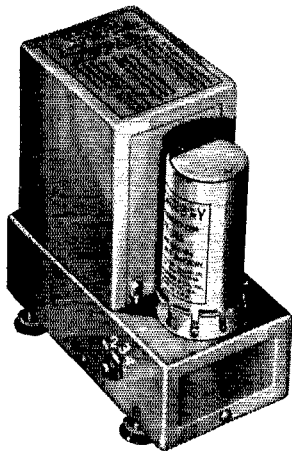

Supplied complete with special design Mallory Long-Life Vibrator. Rectifier tube included with interrupter Models 553 and 554. Average weight only 5½ lbs.

See the Mallory Vibrapack at your nearest Mallory-Yaxley distributor. He has your Data Sheet, "Perfect Portable Power", containing complete specifications and operating instructions. Ask for it!

P. R. MALLORY & CO., Inc.
INDIANAPOLIS INDIANA

Cable Address—PELMALLO

Use
YAXLEY
 APPROVED RADIO
 PRECISION PRODUCTS

Are my reactions typical? This, of course, I don't know. I am a business man—a professional man—no child. My hobby is of vital interest to me. I hope it survives. I have practiced amateur radio since 1920; my first call was just plain 9AGO. I have constructed twelve transmitters, though my present one is commercially built. I am not an engineer, a service man, or a radio politician. I have no axes to grind—I'm just disgusted. After years of silence I've said it.

My business is public relations. I think I know something of this field. I warn amateur radio that unless we move carefully we are following the sunset trail.

—Francis C. Miller, W9RQS

Pick Your Spot on the Neighbors' Supers

(Continued from page 13)

beat will be produced with a given broadcast signal can be found from the formula

$$x = n(a + b) \pm a$$

where a , b and x have the same meaning as before, and n is the number of the harmonic. Putting the formula in another way, the b.c. frequencies at which interference will occur from a given transmitter frequency can be found:

$$b = \frac{x - a(n \pm 1)}{n}$$

For example, if the transmitter is on 3950 kc. and the i.f. is 460 kc., and assuming the 3rd oscillator harmonic,

$$b = \frac{3950 - 460(3 + 1)}{3} = 703.3 \text{ kc.}$$

$$\text{and } b = \frac{3950 - 460(3 - 1)}{3} = 1010 \text{ kc.}$$

In the tables, the left-hand column under each harmonic represents the spurious frequencies obtained by using the factor $n - 1$; each right-hand column shows the frequencies resulting from the factor $n + 1$. The broadcast frequencies shown, it will be realized, do not actually exist; it is simply that a signal will be heard when the receiver is nominally tuned to the frequency indicated. For convenience we call them spurious frequencies or harmonic responses.

I.F. FREQUENCIES

As we stated in the beginning, the whole idea behind this is to endeavor to select an operating frequency which will not interfere with the b.c. stations whose service areas cover the vicinity. This is something each amateur has to figure out for himself; it can be done readily with the aid of the formulas above. However, it is necessary to know what i.f.'s are likely to be in use in the receivers in the neighborhood.

Unfortunately, there is not a high degree of uniformity in i.f.'s used in broadcast receivers manufactured in the past five or six years. A rough check over some data sheets shows that they vary all the way from 125 to 490 kilocycles, a range which makes interference-dodging a rather hopeless proposition. Fortunately, however, the large majority group themselves around 175 and 460 kc., using odd frequencies within 10 kc. or so

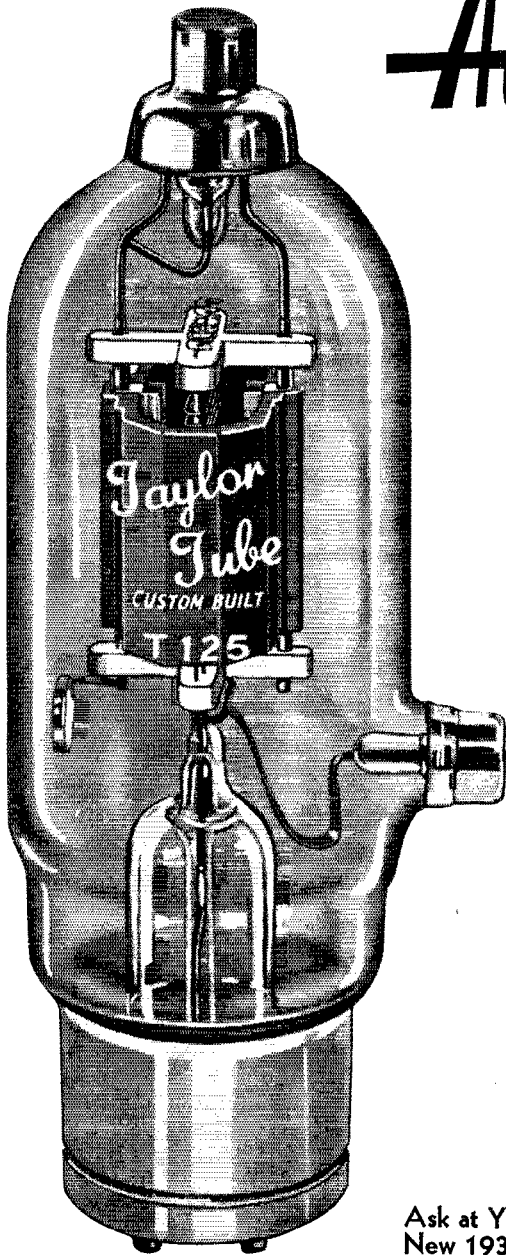

Announcing

THE
1937-1938
SALES CHAMPION

T-125

CARBON-TANTALUM ANODE

Man-sized carbon anode with tantalum fins (patent applied for) makes possible high efficiency at low plate voltages. For the first time low interelectrode capacities and low impedance combined in a tube. Full information with circuits in the new Taylor Tube Manual.

READ THESE CHARACTERISTICS

Fil. Volts.....	10
Fil. Amps.....	3.85
Amp. Factor.....	25
Plate Volts.....	2000
Plate Current.....	200 ma
Plate to Grid.....	4.5 mmf
125 Watts Plate Dissipation	

\$13.50

EASY TO DRIVE!

For C.W. or buffer operation the rectified grid current should be 30 M.A. and for plate modulated phone operation should be 50 M.A. Expressed in terms of power approximately 10 watts of grid drive are necessary for efficient C.W. or buffer operation or 20 watts for phone operation. These are maximum requirements and under normal conditions considerably less grid drive will give efficient performance.

Before You Buy . . . COMPARE!

Ask at Your Favorite Distributor or Write to Us for the Big New 1937-38 Taylor Tubes Catalog and Manual — FREE

"More Watts Per Dollar"

Taylor HEAVY **CUSTOM BUILT** DUTY **Tubes**

TAYLOR TUBES, INC., 2341 WABANSIA AVE., CHICAGO, ILLINOIS

More Distance Per Watt WITH MODULATION MONITOR

DEALER PRICE

\$24.83

MODEL
1295

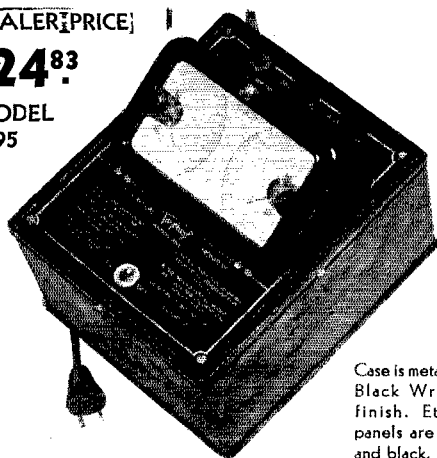

Case is metal with Black Wrinkle finish. Etched panels are silver and black.

For All Voice Transmitting Stations

Model 1295 Modulation Monitor enables you to tune your transmitter to maximum efficiency thereby saving the power loss of under-modulation. Result — clearer signal to distant stations.

Shows actual modulation percentage from 40 to 120 percent.

Eliminates the uncertainty of depending on the ear, variation of antenna ammeter or the loop and light in determining carrier shift and percentage of modulation. Actual modulation percentage is shown on direct reading Triplett Twin Precision Instrument. Factory calibrated and no further calibration needed. Case is metal with Black Wrinkle finish. Etched panels are silver and black.

SEE YOUR JOBBER ■ WRITE FOR CATALOG

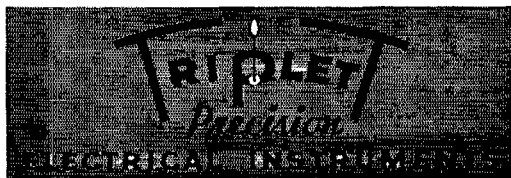

The Triplett Electrical Instrument Company
259 Harmon Avenue, Bluffton, Ohio

Without obligation please send me more information on.....
Model 1295 Modulation Monitor..... I am also interested
in.....

Name.....
Address.....
City..... State.....

of these averages. Practically none of the standard-make receivers brought out within the last two years use the lower frequency, so that it is safe to say that by far the larger number of late-model sets have i.f.'s of 460-470 kc. Two of the largest manufacturers use 460 practically exclusively, so that 460 becomes a good basis for calculation. On the other hand, it is true that a great many of the older sets having i.f.'s around 175 are still extant, and this frequency should not be neglected. Unless a particular receiver having an off-breed i.f. is causing trouble, it is probably safe to base all the calculations on these two frequencies.

PICKING A TRANSMITTING FREQUENCY

Now that we have the system, let's take a hypothetical case and follow it through. Let us suppose that the transmitter is going to operate in the 1800- to 2000-kc. 'phone band, and that there are three local b.c. stations, on 1460 kc., 720 kc. and 950 kc. We want to avoid interfering with these stations, and are assuming that the receiver i.f.'s will be either 460 or 175 kc. We first set up the equations for frequencies which will cause image interference, transposing for convenience:

$$\begin{aligned}x &= 2a + b \\a &= 175 \text{ or } 460 \\b &= 720, 950 \text{ or } 1460\end{aligned}$$

Referring now to Table I, only b.c. stations between 880 and 1080 kc. will be subject to image interference on 460 kc. receivers; in Table II, only stations between 1450 and 1500 kc. Our 950-kc. station falls in the first category, and the 1460 in the second. No images are to be expected on 720, so we can neglect this one for the moment. Substituting in the equation

$$\begin{aligned}x &= (2 \times 460) + 950 = 1870 \text{ kc.} \\x &= (2 \times 175) + 1460 = 1810 \text{ kc.}\end{aligned}$$

These frequencies should be avoided.

Coming now to harmonic beats and again looking at the tables, we find that the 720-kc. station falls both in the second column of Table I and the third column of Table II. The 950- and 1460-kc. stations are entirely in the clear from the harmonic standpoint in both tables in the 1800- to 2000-kc. region, so we don't worry any more about them. Solving the equation

$$x = n(a + b) \pm a$$

for 720 kc. (remembering that in the tables a left-hand column under any harmonic represents "minus" and a right-hand column "plus") we find

$$\begin{aligned}x &= 2(460 + 720) - 460 = 1900 \text{ kc.} \\ \text{and } x &= 2(175 + 720) + 175 = 1965 \text{ kc.}\end{aligned}$$

There is thus a total of four frequencies, two from images and two from harmonics, which will zero-beat with the local stations. On images, the transmitter should be set at least 10 kc. on either side of the spot frequency found above in order that the image will not heterodyne with the b.c. station. On harmonics, the "buffer" region to

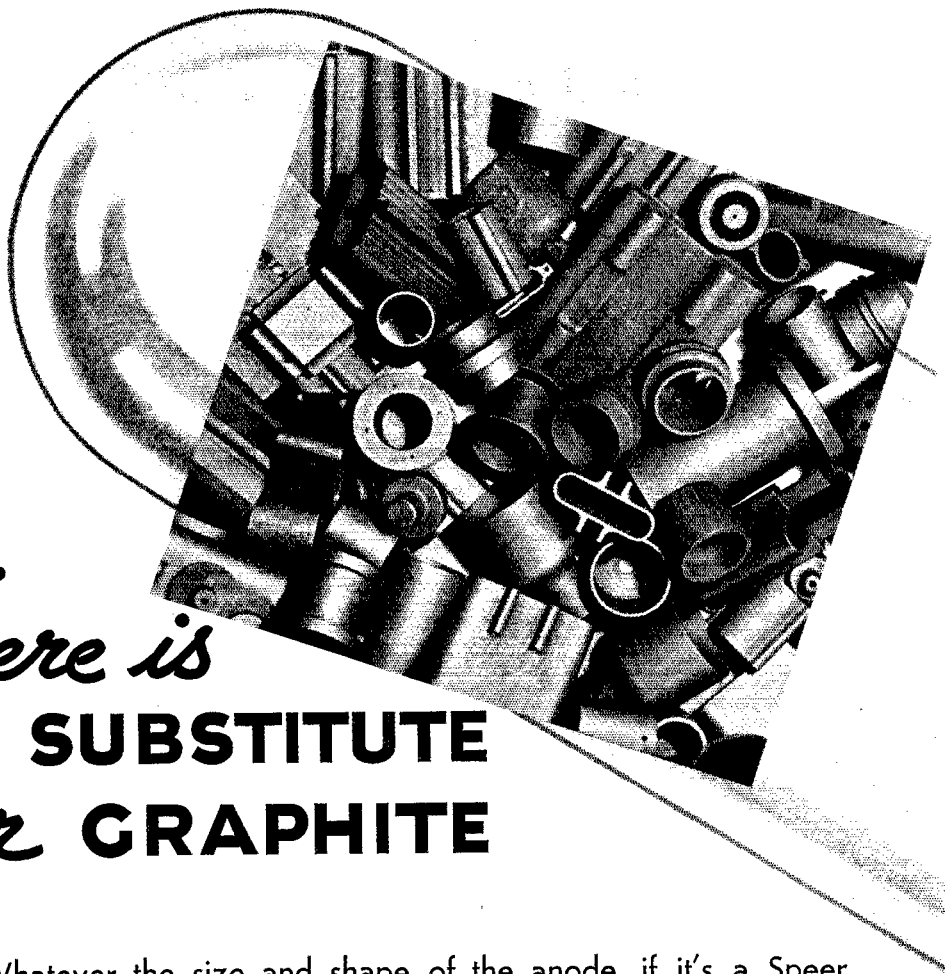

There is
NO SUBSTITUTE
for GRAPHITE

Whatever the size and shape of the anode, if it's a Speer Processed Graphite Anode it cannot fuse or warp, improves the degassing qualities of transmitting tubes, decreases gas trouble, minimizes insulator leakage.

In buying tubes, be sure the Anodes are Speer Graphite. They are used in the better tubes. List of makers and booklet on request.



SPEER CARBON COMPANY

ST. MARYS, PA.

Say You Saw It in *QST* — It Identifies You and Helps *QST*

Ⓢ 7670

81

7 WINNERS *by* Western Electric

For Ultra High Frequency

304B TRIODE

Upper frequency limit—300 megacycles. Maximum voltage—1250 volts. Nominal power output, Class C—unmodulated—85 watts.

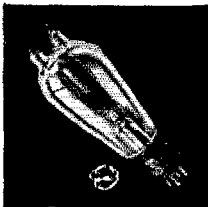

305A SCREEN GRID

Full ratings up to 50 megacycles. Maximum voltage—1000 volts. Nominal power output, Class C—unmodulated—85 watts.

306A PENTODE

Full ratings up to 50 megacycles—reduced ratings up to 70 megacycles. Maximum voltage—300 volts. Maximum power output 8.8 watts.

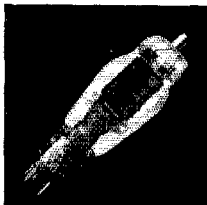

307A PENTODE

Full ratings up to 40 megacycles—reduced ratings up to 70 megacycles. Maximum voltage—500 volts. Carrier power output—20 watts.



316A TRIODE

Upper frequency limit—750 megacycles. Maximum voltage—450 volts. Nominal power output at 500 megacycles—7.5 watts.

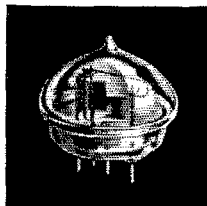

Audio Frequency

300A TRIODE High quality audio. Maximum voltage—450 volts. Maximum output—17.8 watts.

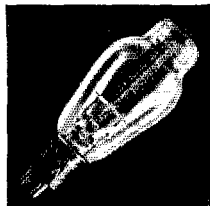

Power Amplifier 242C TRIODE

Maximum voltage—1250 volts. Approximate carrier output, Class B, 100% modulated—50 watts. 100% modulated—Class C nominal power output—130 watts.

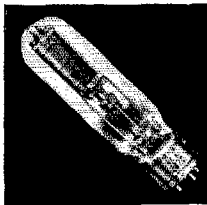

Sold by leading amateur dealers throughout the country—or Graybar Electric Co., Graybar Bldg., New York.

avoid heterodynes should be 10 kc. divided by the number of the harmonic (in this case, 2). Summing up, then, in our hypothetical case the following frequency groups should be avoided: 1800–1820 kc., 1860–1880 kc., 1895–1905 kc., and 1960–1970 kc.

On the 3500-kc. band, the same procedure would be followed except that images may be ignored, since all the possible interference is by beats with oscillator harmonics. As the transmitter frequency is increased the number of possible combinations becomes greater so that a few more calculations become necessary, but the procedure is always the same.

The portion of the band which is "blocked out" on this basis will depend upon the number of local b.c. stations and the frequencies they happen to occupy. In most cases, the area to be avoided will not be unduly great, nor is it necessarily taboo during more than the evening hours when most b.c.l.'s use their receivers. In any event, a transmitter cannot occupy more than one frequency or channel at a time (always excluding overmodulated 'phones!) and if local unpleasantness can be avoided by picking one which won't cause interference, the benefits would seem to more than outweigh the disadvantages of this small concession to a strict interpretation of the rules.

A 50-Watt C.W.-Phone Transmitter for 220-Volt D.C.

(Continued from page 16)

pentode amplifier from the crystal microphone, and resistance coupled to a 6C5, which in turn was transformer coupled to push-pull 6C5's driving the modulators.

The first four tubes have their filaments in series, and dropping resistors are used from the 220-volt line. The two 6L6's have their filaments in series and here again separate resistors were used. Circuit constants other than input and output transformers for the final are strictly conventional. One suggestion might be made, this being that a 6C5 with bias from a Mallory bias cell and cathode grounded would have provided ample gain in the input stage in place of the 6J7. The elimination of the high-gain stage would give less tendency for r.f. pick-up or feedback. The 6L6 tubes used here were the "G" type, this being a matter of our own personal preference. The speech and modulators were assembled in one complete rack unit, a filament volt-meter being connected across one tube filament. This volt-meter is a low current-drain instrument and had no appreciable effect and at the same time served as an over-all line voltage indicator. A plate meter was also provided for the modulators.

In the exciter unit only one milliammeter was included. Jacks and patch-cords were provided, making it possible to check oscillator plate current, buffer-doubler grid current, and buffer-doubler plate current. In the final both grid and plate meters were incorporated. Separate fila-

Amateurs IT'S HERE NEW COMPLETE TRANSFORMER CATALOG



THORDARSON

MEMO

Your copy is waiting for you. Send for it! 24 pages of transformer listings, charts, curves, p.a. units, and oscillographs. Get your copy today from your parts dealer or write us. It's free.
Thordarson

COMPLETE
TRANSFORMER
CATALOG
400-A
FALL—WINTER
1937

THORDARSON ELECTRIC MFG. CO.

500 W. HURON ST., CHICAGO, ILL.

Demand "Power by Thordarson"

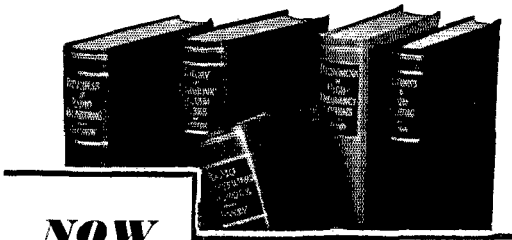

NOW
this high-powered radio engineering library

sent to you for 10 days' trial —
 at a special price and terms

These books cover circuit phenomena, tube theory, networks, measurements, and other subjects — give specialized treatment of all fields of practical design and application. They are books of recognized position in the literature — books you will refer to and be referred to often. If you are a researcher or experimenter — if your interest in radio is deep-set and based on a real desire to go further in this field — you want these books for the help they give in hundreds of problems throughout the whole field of radio engineering.

RADIO ENGINEERING LIBRARY

— especially selected by radio specialists of McGraw-Hill publications

— to give most complete, dependable coverage of facts needed by all whose fields are grounded on radio fundamentals

For home-study and reference. Contains a revised selection of books culled from latest McGraw-Hill publications in the radio field.

5 volumes, 3064 pp., 2000 illustrations

1. Glasgow's PRINCIPLES OF RADIO ENGINEERING
2. Terman's MEASUREMENTS IN RADIO ENGINEERING
3. Chaffee's THEORY OF THERMIONIC VACUUM TUBES
4. Hund's PHENOMENA IN HIGH-FREQUENCY SYSTEMS
5. Henney's RADIO ENGINEERING HANDBOOK

Special Low Price and Easy Terms

Bought singly, the five volumes comprising this library would cost you \$25.00. Under this offer you save \$1.50 and, in addition, have the privilege of paying in easy installments beginning with \$2.50, 10 days after receipt of the books, and \$3.00 monthly thereafter. Take advantage of these convenient terms to add them to your library now.

SEND THIS ON-APPROVAL COUPON
McGraw-Hill Book Co., Inc.
330 W. 42nd St., New York, N. Y.

Send me Radio Engineering Library, 5 vols., for 10 days' examination on approval. In 10 days I will send \$2.50, plus few cents postage, and \$3.00 monthly till \$23.50 is paid, or return books postpaid. (We pay postage on orders accompanied by remittance of first installment.)

Name.....
 Address.....
 City and State.....
 Position.....
 Company..... *QST-9-37*
 (Books sent on approval in U. S. and Canada only)

ment and plate switches were included for audio and r.f. in order that the job could be used on e.w. also. It may be keyed in the plate circuit of any one of the three stages. Keying the oscillator was not found to be best, however. In checks on the air, the transmitter was keyed in the buffer-doubler plate circuit. This gave smooth keying and good stability.

As no d.c. supply was available here, it was necessary to make all tests on the transmitter using a 250-volt generator with field control so that the output could be maintained at 220. Operation was tried with voltage varying from 195 to 230 with very slight over-all effect.

Our checks proved satisfactory. In fact, they were very pleasing and the transmitter was shipped to Antigua. In the first 10 days VP2DA was on the air he contacted approximately 200 stations, these being all over North and South America. With this transmitter he uses an all-wave 220-volt broadcast receiver. He states he has received only one report less than S7; and it was just my luck that I gave him an S5 on our first contact. So go the eccentricities of ham radio.

Modes of Fracture in Piezo-Electric Crystals

(Continued from page 18)

insertion of a 1000-ohm resistor in series with the positive plate lead to the oscillator tube or a smaller resistor in the cathode circuit. The latter will serve to limit the peak values of the transients because of high grid bias; a resistor for this purpose of about 400 ohms will do. A combination of both would probably be workable. If the circuit is broken in and out of oscillation, as when tuning, the resistor acts as a current limiter, tending to make the r.f. plate voltage constant over a considerable capacity range.

Before closing I should like to remark on the self-heating of a crystal and its attendant frequency change. Any circuit which produces strong harmonics and feeds these harmonics back into the crystal circuit will cause increased heating of the crystal. All crystals will pass a certain amount of current at their harmonics, especially the low-coefficient cuts. That this is so can be readily seen by oscillographic examination of the crystal. Any increased reading of the crystal current meter means greater heating of the crystal and increased frequency drift. In order to reduce this drift a holder having a massive bottom plate of high thermal conductivity should be used. A monel metal plate used in a Type 53 oscillator-doubler circuit delivering output in the 7000-ke. band reduced the frequency drift of the X-cut crystal from 780 to 120 cycles as compared to the old holder with small plates. The plate I used was approximately one inch thick and two inches square. Monel was used because it was immediately available; it is by no means the best type of material to use. Copper could be used if it is kept clean. Crystals that are to deliver considerable power should never be mounted between small plates. If you must use a light top plate make sure that the bottom plate is very heavy.

Eastern Air Lines

GO CENTRALAB ALL THE WAY



Thanks! EASTERN AIR LINES, for your gratifying answer to our questionnaire. We are proud to play our part so successfully in maintaining uninterrupted communication between these giant ships of the air and their ground stations. Eastern Air Lines' remarkable record of performance is in no small measure the result of infinite attention to detail . . . and Centralab fits into that scheme with jeweled perfection. For broadcast receivers — for aviation — for replacements . . . wherever smooth reception is wanted. . . . "Go Centralab all the Way."

Centralab variable resistors have been giving very satisfactory service in our ground station and aircraft applications. We find them dependable and economical for many varied applications in our communications equipment.

DON C. McRAE,
Superintendent of Communications

Centralab controls have given excellent service under the exacting requirements of our communications service.

Dependable, noise-free operation has been obtained under extreme ranges of temperature and humidity.

C. H. BATES,
Supervisor, Radio Engineering

We have found Centralab volume controls to be entirely satisfactory in aircraft and ground radio equipment. You cannot surpass them for economy and satisfactory operation.

G. E. SMITH,
Asst. Supt. of Communications

Centralab

Division of Globe Union Inc., Milwaukee

Canterbury Rd., Kilburn N.W. England

118 Ave. Ledru-Rollin, Paris

Say You Saw It in *QST* — It Identifies You and Helps *QST*

Taylor Tubes

We carry the complete line of Taylor Custom Built Tubes — from the first to the last — including the NEW T-125 low C—Low impedance 400 watt. . . **\$13.50**
Get the Taylor Manual — yours for the asking.

Raytheon Tubes

Our stock is complete — we carry all types of Raytheon Transmitting Tubes. Did you read the article on the New Beam Power Tubes in Aug. issue. We can supply you with the RK — 47 Beam Power Amplifier **\$17.50**

RACK PANELS

by LEEDS



are furnished with black shrivel finish in the standard 19" length, 3/4" thick. Western Electric mounting slots or amateur slotting. Masonite Panels, crystalline black and silver gray in W. E. slotting, 3/4" thick.

Steel	Price	Width	Aluminum	Price	Masonite
PS-1.....	\$.52	1 1/4"	PA-1.....	\$.74\$3.36
PS-2.....	.57	3 1/4"	PA-2.....	1.0348
PS-3.....	.68	5 1/4"	PA-3.....	1.3054
PS-4.....	.71	8 1/4"	PA-4.....	1.5567
PS-5.....	.95	10 3/4"	PA-5.....	1.9087
PS-6.....	1.15	10 3/4"	PA-6.....	2.251.05
PS-7.....	1.30	12 1/4"	PA-7.....	2.901.23
PS-8.....	1.50	14"	PA-8.....	3.35	
PS-9.....	1.70	15 3/4"	PA-9.....	3.70	Other sizes —
PS-10.....	1.90	17 3/4"	PA-10.....	3.95	Price on request.
PS-11.....	2.05	19 1/2"	PA-11.....	4.45	State slotting de-
PS-12.....	2.30	21"	PA-12.....	5.20	sired in order.

PAWOOD metal punch for drilling holes; we have the following sizes:

3/4" — 1/2" — 1" — 1 1/4" — 1 3/16" — 1 1/2" each.....\$1.67
No. 5 heavy duty circle cutter, 1 to 5" dia.....\$1.85
No. 4 heavy duty circle cutter, 1 to 4" dia.....\$1.29
Extra blades.....24c

THORDARSON

We have the complete line in stock, including the new C H T line.

VICTRON G

The magic insulator of Radio. See our advertisement in August issue.

LEEDS TRANSFORMERS

— high voltage, completely shielded. See July QST for details and prices.

LEEDS CHOKES

Described in July QST or write us for information.

NAVY TYPE TELEGRAPH KEY



List \$3.60. Navy knob — 1/2" Tungsten contacts. While they last.....\$1.15
With regular knob.....95c

HEINEMANN Circuit Breaker

In attractive bakelite case, easily mounted on panel. Size 4 1/4 x 2 1/4 x 3 1/4; single pole, connected in series with primary. 7 models 5 to 35 amp, 115 volt. Special.....\$3.90

LEEDS Copper Wire Specials Enameled

No. 14...40c. No. 12...60c. No. 10...90c. Copperweld, steel core enameled. No. 14...65c. No. 12...95c. Phosphor Bronze — hard drawn — stretchless and kinkless; high tensile strength. No. 12...\$1.25. Seven strands No. 20 phosphor bronze...\$1.50. Prices quoted above are in 100-foot lengths. Larger quantities in one piece are available.



LEADS THE FIELD

World Wide Service to Amateurs

45 Vesey Street
New York City

Tel. COntlandt 7-2612

Cable Address: "RADLEEDS"

A New Quartz Filter

(Continued from page 85)

With the holder problem solved, the action of the phasing condenser became more normal; but further investigation showed that interfering signals within 1 kc. of a desired signal still could not be phased out. This condition compared unfavorably with the phasing range of the 456-kc. filter, which is normally capable of eliminating signals down to within 300 cycles of the fundamental frequency. As a matter of fact, the limited phasing range had not been entirely unexpected since the anti-resonant frequency of a crystal ordinarily differs from the fundamental by about one-half of one per cent and the separation between the two will, therefore, increase as the i.f. is increased. To overcome this difficulty, the phasing condenser illustrated in the photographs was devised. This condenser is of the differential type wherein the capacity of one section increases as that of the other decreases, thus greatly increasing its effective range, and making possible the rejection of interfering signals down to within about 200 cycles of the fundamental. This, again, represents a considerable improvement over the low-frequency design.

Unfortunately, the introduction of the first condenser tried brought back the interlocking effect, for the two sections were connected in series directly across the selectivity control, and any change in the series capacity which occurred during the phasing operation altered the band width, as before. It was found, however, that by designing specially shaped rotor plates, a true "condenser potentiometer" could be made; that is, the series capacity from stator to stator could be made to remain practically constant, while still maintaining the full capacity range of the individual sections. (The problem was unique — to design a variable condenser having zero capacity change!) In any case, the new phasing circuit is a distinct improvement over the conventional arrangement, and it has still another point in its favor: the useful range of phasing action is spread out over most of the available 180° rotation, instead of being somewhat crowded near either end, as in the case of a phasing condenser using semi-circular plates.

One of the most important elements in the crystal filter is the output system serving to couple the crystal network to the grid of the following tube. The actual function of this portion of the circuit is to terminate correctly the crystal filter proper. Whether or not there is a considerable voltage step-up to the tube grid is relatively unimportant, although this point is usually stressed in discussion of the subject. For instance, with the output section of the filter adjusted to give the greatest voltage step-up, the tuning of the input system (selectivity control) may have no effect whatsoever upon band width. Under these conditions the impedance of the output section may be improper with respect to that of the crystal at resonance. In order to retain control of selectivity it is therefore necessary that the



Leeds LD-5. Mounted crystals. Unconditionally guaranteed; cut to your specified frequency in the 40-80 and 160 meter bands at no extra cost. Only.....\$3.50

Money back guarantee if you are not completely satisfied. LEEDS type A.L. metal crystal holder, as illustrated above, fits standard 5-prong socket.....89c

Pyrex strain insulators 3 3/4".....17c
Pyrex strain insulators 4".....69c
Lead in bushings and 15" brass rod.....\$1.47
Complete line of Johnson & Birnback products in stock.

General Radio

Varifacts and parts in stock

677-U coil forms, 21 turns, 2 1/4" dia. resonant on 3.5 mc. 100 mfd. cap. 50c
677-V — 30 turns 4" dia. resonant 1.7 mc. 100 mfd. cap. 75c

NEW G.R. 8-prong socket; heavy contacts separated by a bakelite wall. The ideal socket today. Each 40c, or 10 for \$2.75

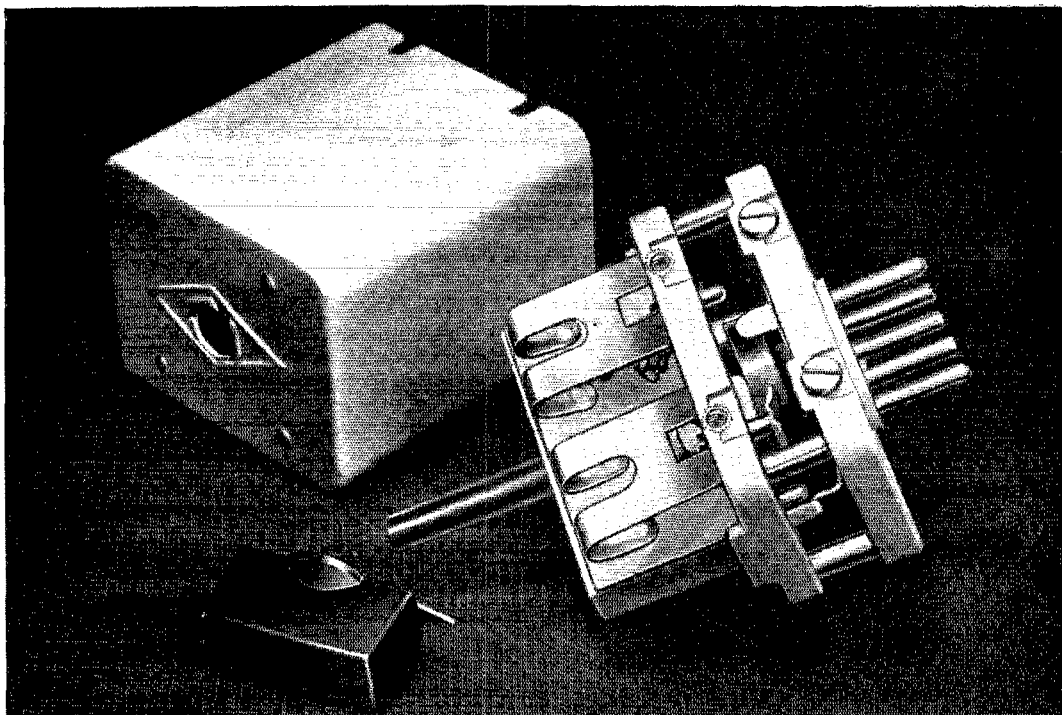

MULTIPLE CRYSTAL HOLDER

A choice of crystal-controlled frequencies are available in the transmitter that uses this new crystal holder. Four separate crystals are accommodated, any one of which may be selected by the built-in switch. One plate, common to all four crystals, is of solid metal $2\frac{3}{16}$ " by $1\frac{1}{4}$ " by $\frac{3}{8}$ " thick. This large mass of metal retards temperature changes and provides cooling for the crystal. The switch has extremely low distributed capacity, insuring that only the desired crystal will be active. The unit has a standard five prong plug-in base and in most cases can be substituted for existing holders without change. Provision has also been made for mounting behind the panel, with front-of-panel control.

Multiple Crystal Holder, Type 4 in 1, Net Price..... **\$4.50**

NATIONAL COMPANY

DEPENDABLE!

GROSS CP-55 and CB-55 TRANSMITTERS

"BUILT LIKE A BATTLESHIP"

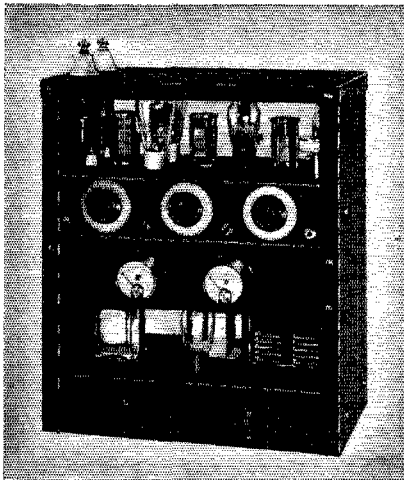

• Full 95 Watts input • New Taylor T20 tubes • Ten Meter operation • Built-in power supply • For operation on 10-20-40-80-160 meters • 3 stages, 42 Osc, 6L6 buffer, 2-T20's in final

KIT \$42.70

LESS TUBES, METERS, CRYSTAL — One set coils included in price

The "CP-55" uses the marvelous new T-20's in the output stage. These real transmitting tubes will give outputs and performance not possible with ordinary receiving tubes — their price is very low.

The ideal unit for the beginner or the "Old Timer" desiring an additional transmitter for operation on 10 meters, or any other band. In the CP-55 you have available an Xmitter having real power at a marvelously low price.

Compare the construction of the "CP-55" with units selling at many times its price. Only finest components are used such as Cardwell Condensers, Steatite Sockets, IRC Resistors, Cornell-Dubilier and Aerovox Condensers, etc.

The CP-55 is converted into a fine RADIOPHONE TRANSMITTER by merely adding an available modulator unit.

Descriptive Bulletin on Request

"CW-55" RF Unit only as used in the CP-55 including one set coils, less tubes, xtal, meters. Kit **\$18.95**

Two full size surface type meters.....\$7.00
Coils, any amateur band listed in features, per set..... 2.85
Kit of Matched tubes for RF Unit..... 6.60
One 83 Tube for power supply..... .65

"CB-55"

The Radiophone version of the "CP-55" — Also sensationally low priced

ALL BANDS INCLUDING 10 METERS
Bulletin gives Details

GROSS RADIO, INC.

51 VESEY STREET NEW YORK
Cable Address: GROSSINC

output section be carefully adjusted with correct regard to the rest of the circuit.

This "matching" process is rather tedious. There are three variables; the capacity variation of the selectivity control condenser, C_1 ; the output coupling capacity, C_5 ; and the position of the tap on the output coil. The first can be readily controlled by fixed shunt condensers, C_2 and C_3 , which, at the same time, serve to provide the center tap for the input coil and to constitute two arms of the crystal bridge. The necessity for a split-stator variable condenser or a center-tapped input coil is eliminated and construction is correspondingly simplified. The output coupling capacity, C_5 , must be adjusted to provide the proper terminating load in conjunction with the output coil. It must not be too large, however, or the rejection characteristic will be adversely affected.

With all circuit constants set for optimum performance, the characteristics of the filter as a whole are as shown in the curves of Figs. 2 and 3. It may be seen that selectivity is variable over an even greater range than was anticipated. In this connection, it should be remembered that the curves show overall i.f. characteristics which include the fixed selectivity of the three i.f. transformers. Although not indicated by the curves, the gain of the filter stage *increases* with narrowing band width—a very desirable characteristic, since it compensates to some extent for side band cutting in 'phone reception and, furthermore, gives added gain just where it is wanted, the signal-to-noise ratio being greatest at maximum selectivity.

Class B Audio Driver

(Continued from page 27)

developed across the primary of the driver transformer is $2\mu E_p$ or 520 volts. The actual value of the voltage at the rated Class-B output is 492.5 volts.

The regulation, then, is $\frac{520 - 492.5}{492.5}$ or 5.6 per

cent, which is a usable value. It is of interest to note that if the plate voltage on the Type 2A3 tubes is 250 volts and if the bias is 45 volts, the driver transformer turns ratio is 2.25:1; and the driver regulation is 11.8 per cent or only half as good as when the Type 2A3 tubes operate at 300 volts. No allowance has been made for driver transformer efficiency. To allow for this, the step-down turns ratio should be decreased by about 5 per cent.

No allowance has been made for the cancellation of plate circuit distortion by the introduction of an equivalent series impedance in the class "B" grid circuit. The assumption is made that the given class "B" plate-to-plate load is optimum so far as plate circuit distortion is concerned.

A great deal has already been written of the actual physical construction of the driver transformer. Therefore, suffice to say that the transformer should have interleaved windings, so arranged that the coupling from either half of the primary to either half of the secondary is identi-

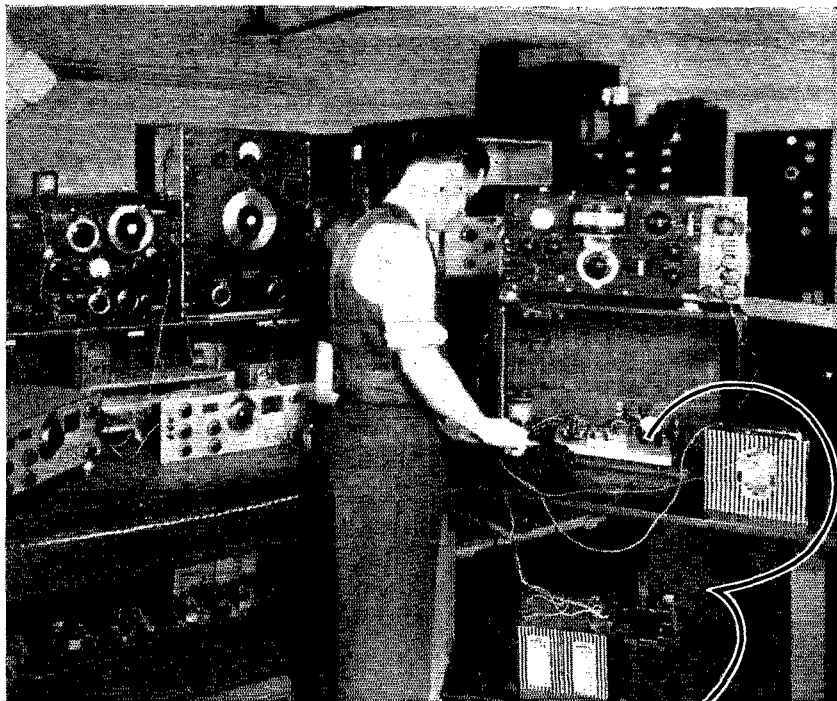

Sign of a Well Equipped Lab —BURGESS Portable Power

Burgess Batteries! They're taken for granted here in the testing laboratory of the Radio Marine Corporation of America in New York City.

In the same way, they're taken for granted by scientists and explorers and amateurs wherever dependable—

unfailing — economical portable power is needed.

Why not enjoy the same sure satisfaction — the same unvarying quality — in your own laboratory for all your experimental work? Always use Burgess Batteries.

Burgess Battery Company
Freeport — — — — Illinois.

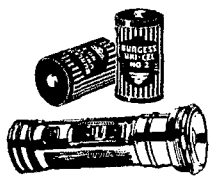

BURGESS



NEW SQUARE METERS ESPECIALLY ADAPTED TO AMATEUR USE

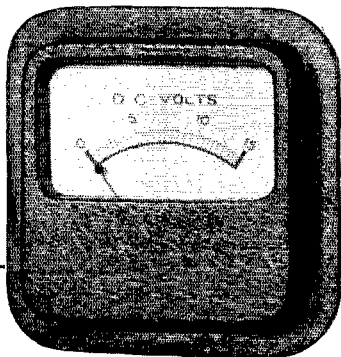

Model
95

Case Size: 2 9/16" x 2 5/8" 3/8" in Front of Panel, 7/16" Back of Panel

Voltmeters, ammeters, milliammeters, in all popular ranges — A.C. and D.C.

Inexpensive instruments, thoroughly reliable for many applications in amateur radio

Ruggedly Constructed Dependable Low Cost

For more information and prices See Your Jobber or Write

READRITE METER WORKS 925 College Dr. Bluffton, Ohio

MIMS SIGNAL SQUIRTER

ROTARY BEAM ANTENNAS

20 and 10 Meters Only

ORDER NOW . . .

BE READY FOR WINTER

By Horizontal Rotation

Better Transmission

Vertical Concentration

Improved Reception with a Revolution to Desired Direction

Signal Squirters are fun. The test is to ask the fellow using one. Better still — see for yourself. Ask for QRA of one nearest you.

"Put Your Signal Where You Want It When You Want It There"

Write for Bulletin SS2

MIMS RADIO COMPANY

M. P. MIMS — W5BDB, P. O. Box 504, Texarkana, Ark.

cal. The primary inductance should be designed on the basis of an unloaded transformer, since with biased Class-B tubes the driver tubes operate into an infinite load during part of the cycle.

In conclusion, by proper design of the driver transformer and with driver tubes of adequate power capabilities, the distortion introduced by the driver stage may be held to a very low value.

Circuit Equalizing to Improve Receiver Performance

(Continued from page 32)

a long and laborious process; that the first part is unnecessary; that the observations are self-evident. Upon closer observation and further study, it will be found that besides pruning the inductances so that $L_1 = L_2 = L_3$, we have also been making variations such that $CT_1 = CT_2 = CT_3$. Neither L_1 nor CT_1 can be measured directly by the home constructor. Instead, the effect on frequency that changes in L_1 and CT_1 and C give, enable us to determine which one must be changed; and what is more important, in what direction the change must be made.

The accuracy of the method is such that any home constructor can equalize inductances and feel positive that values finally obtained are just as close as can be found in the best receivers available.

With the Affiliated Clubs

(Continued from page 34)

banquet, where prizes were distributed to winners of the various events. . . . The Peninsula Amateur Radio Club, Newport News, Va., observed the A.R.R.L. Field Day on June 20th by staging a hidden transmitter hunt. W3AKN/3 was set up on 3635-ke. about ten miles north of Newport News. Five groups in cars equipped with direction finding apparatus took bearings between 1:00 and 5:30 P.M. and plotted on maps for the location of the transmitter. The Newport News and Hampton groups were adjudged first and second winners respectively. Refreshments were served at the conclusion of the hunt. . . . The annual hamfest and banquet of the Electric City Radio Club, Scranton, Pa., was held in that city on May 23d. A trip through an anthracite coal mine started the program at 12:30 P.M.; festivities did not conclude until 10:30 P.M. Good speakers, good food, good prizes made the affair interesting. . . . In conjunction with the annual University Engineer's Day, May 11th, the Colorado University Radio Club held its fifth annual hamfest. An exhibit of radio apparatus built by amateurs was displayed, and the day was climaxed by a picnic in the mountains. 56-Mc. transceivers were in operation from the display room and automobiles in the vicinity. . . . The Annual Spring Meeting of the Tri-County Radio Association, Inc. (Plainfield, N. J.) took place on the evening of April 12th with more than 100 in attendance. Speakers of the evening were W2ICU and W1QP. . . . The South Hills Brass Pounders & Modu-

WHITE HOT!

...without a shadow of doubt the
EIMAC 100TH TUBE
WILL "TAKE IT"

There is no long list of "don'ts" attached to Eimac Tubes. Accidental overloads during adjustment . . . intentional overloads during actual use . . . they'll stand far more than their rating may indicate. "Brute force" methods have been applied in tests over long periods with never a breakdown . . . exceptional results, always.

A new type thoriated filament and tantalum electrodes, as used exclusively in Eimac Tubes, assures extra long life and complete freedom from failure caused by gas.

Do you want a transmitter that will give a powerful, clean cut signal? . . . that is easy to neutralize? . . . that will stay put year after year? . . . then choose EIMAC 100TH TUBES.

Ask your dealer or write for information

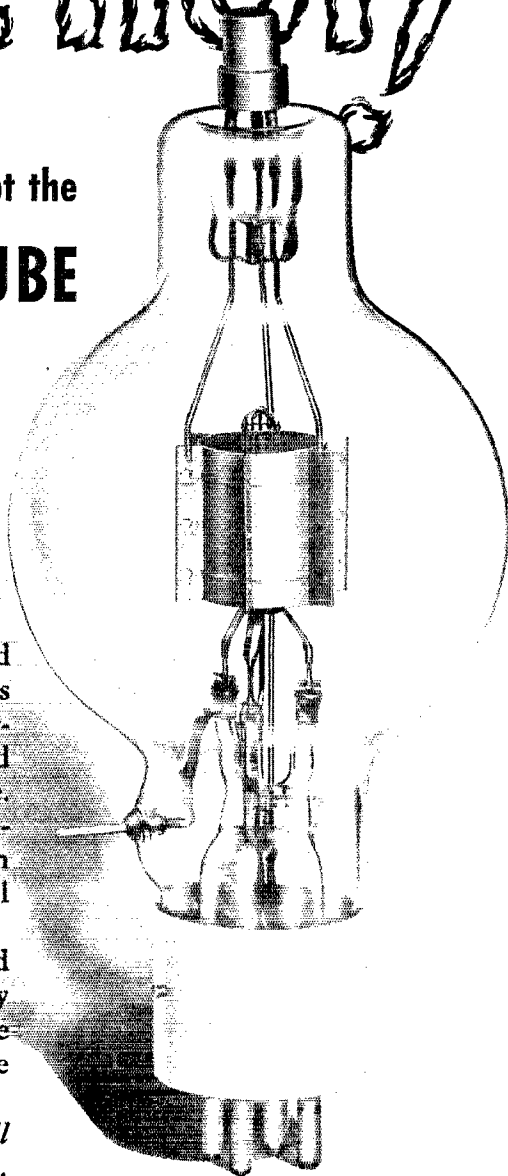

PLAY SAFE . . . INSIST ON

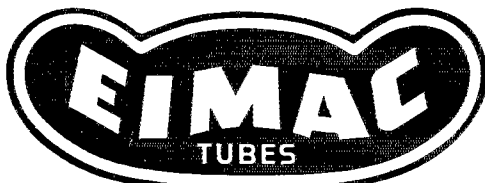

EITEL & McCULLOUGH, INC. • San Bruno, California

STANCOR

TRANSFORMERS

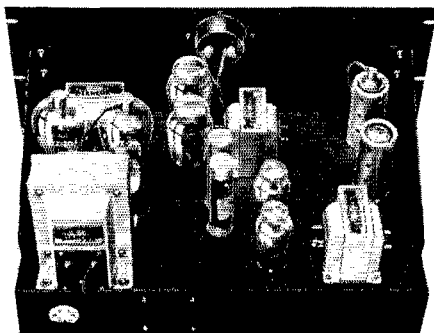

FOR THIS
100 WATT **\$ 12²¹**
MODULATOR

THIS inexpensive but efficient modulator delivers 100 clean watts of audio with 800 volts on the plates of the modulator tubes. Built on standard Relay Rack and Panel.

TUBES: 6C6 Pre-amplifier; 76 voltage amplifier; Push-Pull 76's; 6A3 Drivers; TZ-20 Class B Modulators.

STANCOR TRANSFORMERS: Push-Pull Input, XA4206; Push-Pull Interstage, XA4208; Push-Pull Driver, XA4212; Output, XA2908.

FREE BLUEPRINT AND LAYOUT TEMPLATE

STANDARD TRANSFORMER CORPORATION

850 BLACKHAWK ST., CHICAGO

DID YOU KNOW?

THE VALPEY CRYSTALS have announced the new location of their plant which is devoted entirely to the manufacture and development of piezo electric quartz crystals and mountings. It is more than twice its original size, with new equipment enabling the production of a complete line of frequency control units which will insure you of dependable operation.

- Values — Amateur or Commercial!
- Ask for our NEW ENLARGED CATALOGUE!
- Look for the new units!
- Purchase from your dealer or direct!
- Every item guaranteed!
- Your assurance of satisfaction!

THE VALPEY CRYSTALS

New Address: Highland St., P. O. Box 321, Holliston, Mass.

lators (Pittsburgh, Pa.) had an "overflow crowd" at their clubroom hamfest, March 31st. An effort to keep attendance down to 100, due to clubroom facilities, resulted in an attendance of 156. While some clubs have a hard time getting the crowds out, S.H.B.P. & M. can't keep 'em away. . . .

Get Acquainted!

Clubs are excellent places to get acquainted with radio amateurs and to participate in interesting discussion on our hobby. At A.R.R.L. headquarters there are recorded the addresses of several hundred amateur radio clubs affiliated with the League, their places and times of meetings. Why not drop in at your local club and "meet the gang"? Address the Communications Manager (enclosing 3¢ stamp, please) for data on affiliated clubs in your vicinity.

Miscellany

The Glendale (Calif.) Amateur Radio Club now has a club house of its own. An old boat factory was rented and the members have been spending their Sundays cleaning up the place and giving it a coat of paint. Club colors are red and white, so the building has been painted white, trimmed in red. . . . The Peninsula Amateur Radio Club, W3ESR, holds meetings at American Red Cross Headquarters, Newport News, Va. This affords desirable liaison between the local amateurs and the Red Cross. . . . W8OVE is the present call of the Cleveland Heights High School Amateur Radio Club. P.P. '10's are used in the final transmitter stage, operating frequency 7232 kc. . . . The Olney Amateur Radio Club of Philadelphia has a new B.C.L. "Interference and Pootleg Committee," duties being to discourage bootleg operation and help amateurs clear up B.C.L. QRM difficulties. . . . Probably the smallest club publication in existence is "The Transmitter," issued monthly by the Miller (S. Dak.) Amateur Radio Club—it measures 2¾ by 4¼ inches and is printed in book style. It's mailed to every amateur in the Dakotas. . . . The Cambridge (Ohio) Radio Club is over ten years old. Retaining its original name it now has branched out to include surrounding towns, becoming inter-city in character. . . . The Connecticut Brasspounders Association is fortunate to have the call WICBA. The Association has its own club house and one of the most beautiful masts you'd wish to see. . . . "Les Amateurs Canadiens-Francais de la TSF" of Montreal have a club station operating under the call VE2DN. . . . The Birmingham (Ala.) Amateur Radio Club is the proud owner of a club house atop Red Mountain, providing a dandy take-off point for signals from the club station, W4CUE. . . . The Bridgeport (Conn.) Amateur Radio Association owns and operates W1JHT. . . . On condition that members of the Victoria Short Wave Club would dismantle an old house for him, VE5IE offered them enough lumber and bricks to build a club house. They took him up on it and VE5EZ and other club properties will soon have a new home. . . .

—F. L. B.

HEAVY-DUTY GENERATORS

FOR POLICE CARS

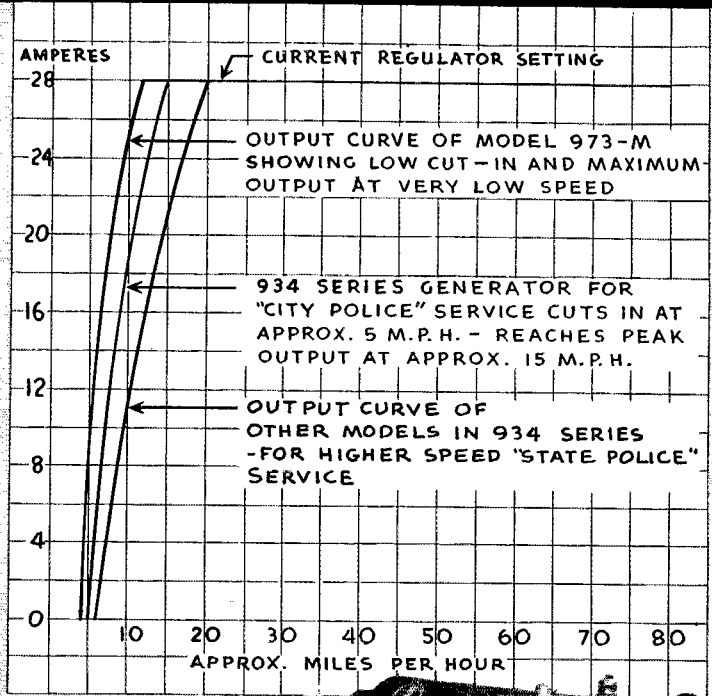

Since the development of radio equipment for police cars, Delco-Remy heavy-duty generators have been greatly in demand by many city and state police departments. These units are designed to develop ample current for the especially heavy demands of police service—at all times. Each unit is built to Delco-Remy's long-established standards of workmanship and materials, assuring dependability under the most

exacting conditions. To suit various types of radio installations, Delco-Remy provides a wide range of generators in sizes and output for every type—at prices that keep well within operating budgets.

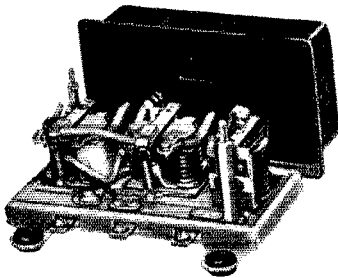

CURRENT AND VOLTAGE REGULATOR. *Furnished with these generators, limits the output to battery and load requirements—does not cause radio interference.*

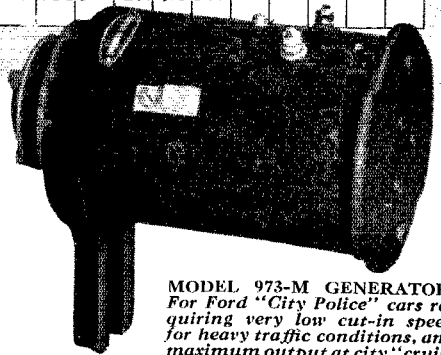

MODEL 973-M GENERATOR. *For Ford "City Police" cars requiring very low cut-in speed for heavy traffic conditions, and maximum output at city "cruising" speeds.*



934 SERIES GENERATORS. *Heavy-duty shunt-wound units. Deliver up to 28-amperes constant output. Available with pulleys for "State" or "City" Police work. Mountings to fit most popular cars.*

Delco-Remy

ANDERSON, INDIANA



Delco-Remy products are sold and serviced by United Motors Service Stations everywhere . . . wherever you see this sign.

World's Largest Manufacturer of Automotive Electrical Equipment

Say You Saw It in QST — It Identifies You and Helps QST

OHMITE

VITREOUS ENAMELED RHEOSTATS

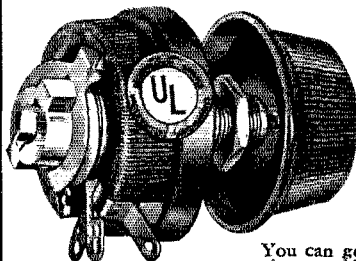

for
**CLOSER
FILAMENT
VOLTAGE
CONTROL**

You can get higher efficiency and longer life out of your transmitter tubes, when you control the filament power supply in the transformer primary circuit with an Ohmite Rheostat. They're all-metal and porcelain construction, built just like Ohmite's big industrial units with many turns that provide the close graduation needed for perfect control. A real unit for the amateur that wants his "rig" in top operating condition at all times.

Ask Your Jobber or Write for FREE Catalog

OHMITE MANUFACTURING CO.
4831 Flournoy Street, Chicago, Ill.
RESISTORS — RHEOSTATS — TAP SWITCHES

Double Your Power!

At the Useful Voice Frequencies

Cut through QRM with a voice that can be understood. You don't need tricky high gain amplifier with this tremendously efficient voice microphone. Eliminates all RF feedback troubles with its "airtight" shielding. Cuts out your hum problems too. You'll get more satisfaction out of the dollars spent on a Vt-73.



Model VT-73

THE TURNER COMPANY
CEDAR RAPIDS, IOWA

Licensed under patents of the Brush Development Company

LIST—

- MIKE
- STAND
- PLUG

\$27.50

Write now for
bulletin 10-C

A Multi-Use Meter for the Amateur Station

(Continued from page 41)

but no external ground connection should be used. One side of the 110-volt line already is grounded, and should the "hot" side of the line inadvertently be connected to the case and the case grounded directly, the line would be short-circuited. Avoid placing the case on grounded metal objects such as radiators or water piping.

A.R.R.L. QSL Bureau

FOR the convenience of its members, the League maintains a QSL-card forwarding system which operates through volunteer "District QSL Managers" in each of the nine United States and five Canadian districts. In order to secure such foreign cards as may be received for you, send your district manager a standard No. 8 stamped envelope. If you have reason to expect a considerable number of cards, put on an extra stamp so that it has a total of six-cents postage. Your own name and address go in the customary place on the face, and your station call should be printed prominently in the upper left-hand corner.

- W1—J. T. Steiger, W1BGY, 35 Call Street, Willimansett, Mass.
W2—H. W. Yahnel, W2SN, Lake Ave., Helmetta, N. J.
W3—R. E. Macomber, W3CZE, 418 10th St., N. W., Washington, D. C.
W4—B. W. Benning, W4CBY, 520 Whiteford Ave., Atlanta, Ga.
W5—E. H. Treadaway, W5DKR, 2749 Myrtle St., New Orleans, La.
W6—D. Cason Mast, W6KHV, 423 East E St., Ontario, Calif.
W7—Frank E. Pratt, W7DXZ, 5023 So. Ferry St., Tacoma, Wash.
W8—F. W. Allen, W8GER, 324 Richmond Ave., Dayton, Ohio.
W9—Roy W. McCarty, W9KA, 11 South Michigan Ave., Villa Park, Ill.
VE1—J. E. Roue, VE1FB, 84 Spring Garden Rd., Halifax, N. S.
VE2—C. W. Skarstedt, VE2DR, 236 Elm Ave., Westmount, P. Q.
VE3—Bert Knowles, VE3QB, Lanark, Ont.
VE4—George Behrends, VE4RO, 186 Oakdean Blvd., St. James, Winnipeg, Manitoba.
VE5—E. H. Cooper, VE5EC, 2024 Carnarvon St., Victoria, B. C.
K4—F. McCown, K4RJ, Family Court 7, San-turce, Puerto Rico.
K5—John J. Carr, K5AV, 78th Pursuit Squadron, Albrook Field, Canal Zone.
K6—James F. Pa, K6LBH, 1416D Lunalilo St., Honolulu, T. H.
K7—Leo E. Osterman, K7ENA, Customhouse, Wrangell, Alaska.
KA—George L. Rickard, KA1GR, P. O. Box 849, Manila, P. I.

More GRID-MODULATED POWER OUTPUT from the HK-154



\$12.50

AT YOUR
DEALER'S

Compare
GAMMATRON
before
YOU BUILD YOUR RIG
—AND GET THE
MOST FOR YOUR MONEY!

LOW COST UHF TUBES

Type	Rated Plate Dissipation Watts	Grid Modulated Carrier Watts	PRICE	Carrier Watts Per Dollar
154 Gammatron	50	70*	\$12.50	5.6
Tube A	100	54	\$13.50	4.0
Tube B	55	31	\$8.00	3.9
Tube C	35	21	\$8.00	2.6
Tube D	50	22	\$10.00	2.2
Tube E	35	19	\$8.00	2.4

* The Type 154 GAMMATRON is ideally suited to grid modulation. Because of its high overload capacity, conservative plate rating and its low amplification factor, the HK 154 far outstrips its competitors in the same price class for this purpose.

Because of its characteristics and because a release of plate supply power takes place during peaks, linear grid modulation is possible at efficiencies in the order of 50% with the HK 154; with other tubes of higher mu, efficiencies greater than 30 to 40% are unattainable.
Complete information on just how this can be done is yours for the asking.

HEINTZ AND KAUFMAN
LTD
SOUTH SAN FRANCISCO CALIFORNIA U.S.A.

**ultra-
high**

"5-10" RECEIVER

- Tuned R.F. and Controlled Super-Regeneration 5 & 10 meters
- 4 Metal Tubes
- 5 inch Dynamic Speaker
- Only 9 3/4" x 6 3/4" x 5" IDEAL FOR MOBILE INSTALLATION

\$28.00

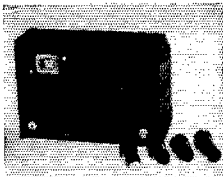

**5 METER DUPLEX
TRANSMITTER-RECEIVER**

- T.R.F. and Super-Regeneration
- 7 Tubes — 5" Dyn. Speaker
- 6E6 Unity Coupled
- 10 watt Carrier
- 100% Modulation
- Duplex Operation — PHONE ● MCW

TRANSMITTER—
RECEIVER

\$47.70

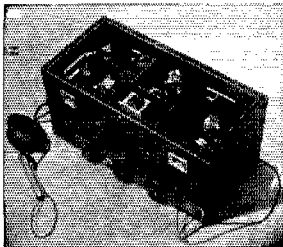

RADIO TRANSCIEVER LABORATORIES
8627 — 115 Street, Richmond Hill, New York

**An Exceptional Dynamic
Transmitting Microphone**

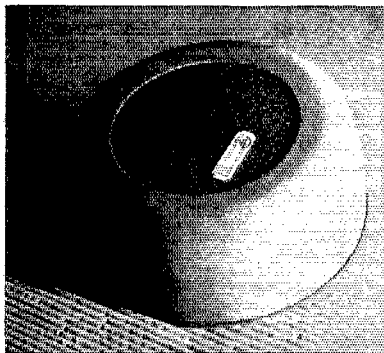

At
A
New
Low
Cost

- Quiet operation for years
- Sturdy Construction
- High Level Output
- Requires little preamplification

THE Model T.B.C. 1000 is an excellent dynamic Microphone for use in the up-to-date amateur radio station. The operating unit is housed in a steel cabinet having a soft taupe suede finish which will be a pleasing addition to any surroundings. It may be placed on the table or hung on the wall. Size diameter 6 3/4", height 3" — Impd. 500 ohms. Write for literature and new low cost. Wright-Decoster Distributors are always anxious to cooperate.

WRIGHT-DECOSTER, INC.

2259 University Ave. St. Paul, Minn.
Export Dept.: M. Simons & Son Co., New York
Cable Address, "Simontrice"
Canadian Representatives
Wm. F. Kelly Co., 1207 Bay St., Toronto, Ont.
Taylor & Pearson, Ltd., Edmonton, Alt.

An A.V.C.-Controlled Pre-Amplifier

(Continued from page 43)

rent drops slightly as the a.v.c. comes into action.

The output circuit shown in Fig. 1, consisting of meter *O* and resistor R_{10} , was used for testing purposes and is not a part of the amplifier itself. R_{10} is an adjustable unit, used in conjunction with *O*, a Weston Model 571 output meter, to bring the load resistance to a value matching the tube through T_4 , for the purpose of calculating the power output.

Standard Frequency Transmissions

Date	Schedule	Station	Date	Schedule	Station
Sept. 1	BB	W9XAN		A	W9XAN
Sept. 3	BB	W6XK	Oct. 2	BX	W6XK
	A	W9XAN	Oct. 3	C	W6XK
Sept. 4	BX	W6XK	Oct. 8	A	W6XK
Sept. 5	C	W6XK	Oct. 15	B	W9XAN
Sept. 10	A	W6XK		B	W6XK
Sept. 17	B	W9XAN	Oct. 20	C	W9XAN
	B	W6XK	Oct. 22	B	W9XAN
Sept. 22	C	W9XAN		A	W6XK
Sept. 24	B	W9XAN	Oct. 27	BB	W9XAN
	A	W6XK	Oct. 29	BB	W6XK
Sept. 29	BB	W9XAN		A	W9XAN
			Oct. 30	RX	W6XK
Oct. 1	BB	W6XK	Oct. 31	C	W6XK

STANDARD FREQUENCY SCHEDULES

Time (p.m.)	Sched. and Freq. (kc.)		Time (p.m.)	Sched. and Freq. (kc.)	
	A	B		BB	C
8:00	3500	7000	4:00	7000	14,100
8:08	3800	7100	4:08	7100	14,100
8:16	3700	7200	4:16	7200	14,200
8:24	3800	7300	4:24	7300	14,300
8:32	3900		4:32		14,400
8:40	4000				

Time (a.m.)	Sched. and Freq. (kc.)	
	BX	
6:00	7000	
6:08	7100	
6:16	7200	
6:24	7300	

The time specified in the schedules is local standard time at the transmitting station. W9XAN uses Central Standard Time, and W6XK, Pacific Standard Time.

TRANSMITTING PROCEDURE

The time allotted to each transmission is 8 minutes divided as follows:

- 2 minutes—QST QST QST de (station call letters).
 - 3 minutes—Characteristic letter of station followed by call letters and statement of frequency. The characteristic letter of W9XAN is "O"; and that of W6XK is "M."
 - 1 minute—Statement of frequency in kilocycles and announcement of next frequency.
 - 2 minutes—Time allowed to change to next frequency.
- W9XAN: Elgin Observatory, Elgin National Watch Company, Elgin, Ill., Frank D. Urie in charge.
W6XK: Don Lee Broadcasting System, Los Angeles, Calif., Harold Perry in charge.

Schedules for WWV

FOR transmissions and schedules of standard time intervals and ionosphere bulletins see "WWV Services Again Expanded," June, 1937, QST.

Each Tuesday, Wednesday and Friday (except legal holidays), the National Bureau of Standards station WWV will transmit on three frequencies as follows: 10:00 to 11:30 A.M., E.S.T., 5000 kc., noon to 1:30 P.M., E.S.T., 10,000 kc., 2:00 to 3:30 P.M., E.S.T., 20,000 kc.

14

Ultra-High-Frequency Transmitters

For interest in the amateur radio community, the UHF band is the most important. It is the only band in which the amateur is permitted to transmit. The UHF band is also the only band in which the amateur is permitted to receive. The UHF band is also the only band in which the amateur is permitted to use a power output of 100 watts. The UHF band is also the only band in which the amateur is permitted to use a frequency range of 30 to 300 MHz.

The Radio Amateur's Handbook



Accessories for the Ultra-High Frequency



Ultra-High-Frequency Transmitters



The Radio Amateur's Handbook



The Radio Amateur's Handbook



The Radio Amateur's Handbook



The Radio Amateur's Handbook



The Radio Amateur's Handbook



UHF

The complete constructional dope on UHF is in two large chapters in the RADIO AMATEURS HANDBOOK

POSTPAID IN CONTINENTAL U.S.A. \$1.25 Postpaid Elsewhere

AMERICAN RADIO RELAY LEAGUE, Inc. West Hartford, Conn.

13

Receivers for the Ultra-High Frequencies

For interest in the amateur radio community, the UHF band is the most important. It is the only band in which the amateur is permitted to transmit. The UHF band is also the only band in which the amateur is permitted to receive. The UHF band is also the only band in which the amateur is permitted to use a power output of 100 watts. The UHF band is also the only band in which the amateur is permitted to use a frequency range of 30 to 300 MHz.



Save Time and Costly Experimentation

Build the PROGRESSIVE III

450 WATT INPUT, C.W.,
AND PHONE ON 10—
20—40—80—160 METER
BANDS.

THE radio amateurs — our country's reserve communications system — right now should be given every cooperation towards obtaining high power at low cost.

"PROGRESSIVE III" — Build it yourself — and you'll be ready when D X weather comes. Ingenious design has kept circuit capacities extremely low, permitting full power input either CW or phone — even on the 10 meter band. The circuit remains neutralized, permitting fast, easy band changing with plug-in coils.

It's easy to build, "step-by-step" if you wish, from standard parts on panels and chassis completely drilled with sockets installed. Circuit diagrams, directions, etc. in AMATEUR TRANSMITTER MANUAL, 25c from your jobber or Amateur Press, 533 S. Throop St., Chicago.

GENERAL TRANSFORMER CORP.
1288 W. Van Buren Street
CHICAGO

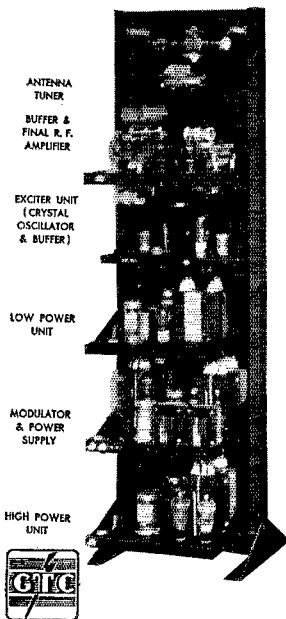

ASK YOUR JOBBER OR WRITE FOR FREE BULLETIN 44

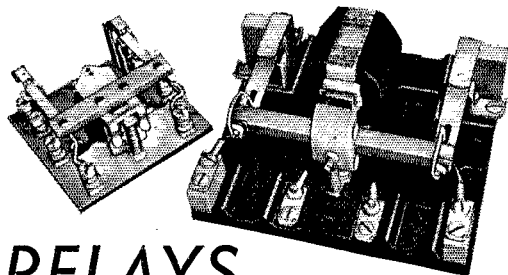

RELAYS for Antenna Changeover

You need one of these relays to change automatically from sending to receiving. You will find these Relays described on pages 5 and 6 of bulletin 507B. Send for a copy. See our booth at Port of Authority Building, New York.

WARD LEONARD RADIO SPECIALTIES

WARD LEONARD ELECTRIC COMPANY
41 South Street, Mount Vernon, New York
Please send me pages 5 and 6 of Bulletin 507B.

Name

Street

City and State

Call Signal

98

Say You Saw It in QST — It Identifies You and Helps QST

Adding Super-Regeneration to an SW3 for Use with the High Stability 56-Mc. Converter

(Continued from page 53)

receiver capable of receiving the most stable c.w. and 'phone signals with good selectivity and, at the throw of a switch, the receiver, with its superregenerative second detector, was capable of accommodating the broader and less stable signals. The performance with the superregenerative second detector is somewhat similar to the super-infra-generator² except that it lacks the sharp selectivity contributed by the 1600-kc. i.f. channel used in the S.I.G. It is interesting to observe, however, that a stable signal (little or no frequency modulation) is louder with the second detector regenerative than with it superregenerative. This condition probably results from the better selectivity and consequent higher signal/noise ratio obtained with the straight regenerative detector. However, on "wobulated" signals the "supering" second detector shows up to much greater advantage. Of course serious 56-Mc. experimenters are turning to the more stable type of transmitters and to more selective receivers as they realize that it will extend their normal operating range. And it surely extends their operating enjoyment!

² R. A. Hull, "A New Receiving System for the Ultra-High Frequencies," QST, November, 1935.

New Receiving Tubes—6J5, 6Y6G, 6Z7G, 6ZY5G

PERHAPS it's stretching things a bit to call the 6J5 a "new" tube, since the 6J5G, which has the same electrical characteristics, has been on the market for about a year. However, this improved general-purpose triode is now available from RCA in metal, for those who prefer steel to glass. For those who don't remember, the 6J5 and 6J5G have an amplification factor of 20, mutual conductance 2600. A good oscillator, especially at the ultra-high frequencies.

Raytheon announces the three types with the tongue-twisting numbers in the title. The 6Y6G is a tetrode power amplifier designed to give more output with 135 volts on plate and screen than the 42 with 250 volts. It was developed for small a.c. receivers where a difference of 100 volts in the power transformer makes an appreciable difference in the manufacturing cost. With a 135-volt supply, an output of 3.6 watts (2.5 per cent second harmonic, 9 per cent third harmonic) can be obtained. Heater takes 1.25 amp. at 6.3 volts; plate current 60 ma., screen current 3 ma.

The 6Z7G is a twin triode for Class-B service, built for applications where low heater current is important, as in auto sets. Heater current is 0.3 amp. at 6.3 volts. The audio power output varies between 2.8 watts at 135 volts to 4.2 watts at 180 volts, the maximum rating. Peak current per plate is 60 milliamperes.

(Continued on page 118)



T. R. McELROY
 World's Official Champion
 Speed 69 w.p.m.

McELROY SAYS: "The CANDLER SYSTEM is the only training I had for my championship contests. It taught me the Coordination and Concentration so necessary to the handling of code at high speed. The CANDLER sound system is exclusive and scientific. I recommend it to those wanting to learn code right, as they'll be using it over the air, and to those who want speed."

CANDLER SYSTEM CO.
 DEPT. Q9
 ASHEVILLE, N. CAROLINA, U. S. A.

CANDLER ADVANCED TRAINING WILL SPEED UP YOUR CODE

If you would like to "punch a mill" at high speed, and copy a full sentence behind — if you want to acquire professional technique so that you can qualify as a commercial operator — YOU ARE THE MAN I AM LOOKING FOR! In just a few weeks I'll have you receiving fast stuff, by touch! Don't struggle on by yourself. Practice alone won't do it. Candler training will so develop your *sound consciousness*, that in an amazingly short time you'll be taking it as fast as they can send it. Just mail the coupon below. Let me show you how easily and inexpensively YOU can be a SKILLED RADIO OPERATOR!

MAIL COUPON TODAY FOR FREE BOOK

CANDLER SYSTEM CO., Dept. Q9, Asheville, N. Carolina
 My present receiving speed is..... w.p.m. Send me Free Book of Facts.
 Name..... Address.....
 City..... State.....

Radio Operator's
 Course
 Telegraphy—
 Telephony
 Aviation

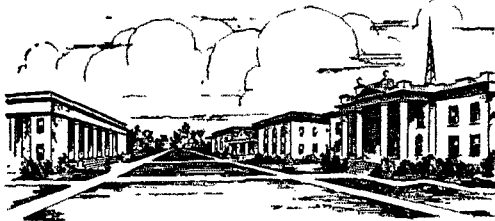

Practical
 Experience
 Studio—
 Transmitter—
 Announcing

PORT ARTHUR COLLEGE has been teaching Radio for twenty-eight years, and during this time it has never been our policy to guarantee positions to prospective students, directly or indirectly. We believe it wisdom at this time, however, to go on record in our *QST* advertising to say that it is impossible for us to even come near to supplying the demand for Radio Operators received by our Employment Department. We do not mean by this that all students who enroll will automatically secure positions. The demand is for graduates — good men who deserve and are qualified to hold positions. The graduates of our Radio School, so far as we know or can learn, are employed 100%.

It is possible for every student who enters the P. A. C. Radio School and completes the course in keeping with our standards to receive employment as a Radio Operator for our station

K P A C at the transmitter, in the control room, as trans-radio press operator, or announcer, and not only earn more money than he pays for the training but to also continue his training as a post-graduate student in advanced work and prepare himself to secure and hold operating positions in the upper bracket of broadcasting, marine work, announcing, or airways.

Port Arthur College advertises primarily to Radio Amateurs, and the training is too technical for the average student who has not selected Radio as his life's work. We know the opportunities for positions and advancement are unlimited for men who are interested in Radio and who plan to make this their career and are willing to make the sacrifice and effort necessary to master our training. P. A. C. maintains strict collegiate rank — only high school or college graduates are eligible for enrollment.

If interested in details about Radio Course, write for bulletin R

PORT ARTHUR COLLEGE - PORT ARTHUR (World-known port) TEXAS

QUARTZ CRYSTALS

ALL TYPES. Low Temperature Coefficients. X and Y cuts Holders. Ground to any practical specifications.

Write for complete particulars

Bellefonte Radio Eng. & Mfg. Co.
 BELLEFONTE, PA.

110 VOLTS AC Anytime! Anywhere! With KATOLIGHT PLANTS

850 Watts AC and 6 Volts DC - \$ 85.00
 850 Watts AC and 6 Volts DC - 225.00
 1000 Watts AC and 18-32 Volts DC 294.00
 Portable—Self-Charging
 Ask for Special Discount to Amateurs
 300 wats 110 v. A.C. Generator only \$19.95
 6, 12, 25 and 110 volt. Battery Converters.
 AC/DC and DC Generators. Etc., etc.

Write for Details
KATO ENGINEERING COMPANY
 Mankato, Minnesota, U.S.A.

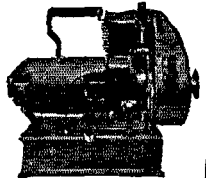

(Continued from page 68)

the summer and has 1.75-Mc. 'phone rig with him. RR (Grimsby) is rebuilding for 14 and 3.9-Mc. 'phone with 250 watts of power. AND is trying to locate a YL op on 3.5-Mc. c.w. ABM reports working a K6 on 7 Mc. with 10 watts to a 6L6. ALH reports for first time from Woodstock; he has just completed an 11-tube super with band switching, noise silencer and heterotone osc. AKX has 8-tube super with band switching—he uses an RK-20 in the final of his rig. NC had visits from YS and NP. AU is having his O.R.S. ticket reinstated after four months' leave. The S.C.M.'s trophy, for Field Day operation, is on hand awaiting the announcement of this year's winner. It is a lovely cup, eleven inches high. AGM has new rig running O.K. and is anxious to have a Northern Ontario Net this winter. If interested, get in touch with him. LI is at Ottawa "Y" Boys' Camp at Golden Lake. QB will have a.c. power before this appears in print. GG has been surveying his city back yard and it looks as though it will have to be a vertical.

Traffic: VE3SG 7 AU 2 QB 1.

QUEBEC DIVISION

QUEBEC—SCM, Stan Comach, VE2EE—AR had the cast removed from his ankle. GE returned to our District. GP deserves congrats; a young op now graces his home. AP is back with us. CX has been vacationing with the G's. JK is spending his summer holidays up North with NI. KM is rebuilding. KX is at Lac St. Jean for the summer. MW will be on with a pair of 100TH's. LV erected a new pair of masts; the distance between his back mast and LC's front one is approx. 50 feet. HT keeps the traffic moving. LE spent his vacation around Montreal. GA promised his son that when he passed his license exam he could have the rig; GA is soon due to build himself a transmitter; LJ is active with new modulator. FG is operating from new address in N.D.G. BV is operating at Valois for the summer and has worked all continents on c.w. Now that the desk has arrived, EW will have to knock new holes in the wall. hi. G5WH was a visitor to Montreal early in June. In an effort to let the gang meet the gang I will list every month calls I would like to hear from . . . will the following fellows please drop me a line before Sept. 16th: AF, BJ, CT, DP, EL, FX, GM, HZ, IX, JR.

Traffic: VE2HT 21 Dr 1 KF 4 EE 5.

VANALTA DIVISION

ALBERTA—SCM, Alfred D. Ketterbach, VE4LX—The N.A.R.C. 1937 Hamfest is over and all in attendance agree it was the best yet. The committee, LQ, HJ, EA, HM and BW, worked hard. Seen at the hamfest: AH enjoying himself at the banquet. BP, VJ, XF,AEA and AEN cheering the efforts of the c.w. men in the boat race. All the gang admiring FR's FB antenna layout, and station. HJ, the club Secy.-Treas., raking in the shekels. JP winning the boat race for 'phone. The Vegreville gang talking hamfest. BA, HH and DH meeting old friends. HF explaining what is meant by "flea power DX." TF ably handling the M.C.'s job at the banquet. VZ walking off with the "Prevaricators Club" Diploma. GA at the banquet telling the boys to "Dump it in." GE and YD enjoying every minute of the hamfest and posing for photos. XE being towed home from Lakeview. XA on duty at CJCA. NS' dad meeting the boys. GA receiving Prof. Buzzoff's "Beer-bottle Oscilloscope," on behalf of the Saskatchewan boys. HT explaining where the factor \$25 comes from. ABH, ADD, ADW, AEN and AGZ raising the roof. QX and EH battling for the "bun-eating championship" at the picnic. BV taking "candid camera" shots of the gang with his Home-Movie Camera. BW working hard on Prof. Buzzoff's equipment. EA displaying brand-new rig to the gang. EW showing the gang the works at CJCA. HM making photographic record of hamfest events. LQ busy making identification tags for the boys. UY helping with equipment at the technical session. AIS and FQ are new Alberta calls at Barrhead and Viking respectively. FQ is MO's brother. PZ argues with his brother over the advisability of foot-feed voltage control for his contemplated bigger and better "watt eater" this fall. ZI is still calculating the wind velocity that dismantled his zepp ant. while he was away.

Traffic: VE4LQ 7 GE 6 LX 4 SW 4 QK 1.

PRAIRIE DIVISION

MANITOBA—SCM, A.J.R. Simpson, VE4BG—GQ's pair of T55's, Class B modulated on 14-Mc. sound FB. QO, who recently acquired NT's rig, is putting out a

first-class 'phone signal on 14 Mc. AG is faithfully on 3.5 Mc. with his 'phone. QRN has not discouraged AAW from keeping a few schedules. FS spends most of his time operating from AFM. GC is heard on 14-Mc. c. w., taking time out from his 56-Mc. activities. Among the lucky vacationers we have IP, who at present is in California, and GL, who will shortly be leaving for southern points. ZV is back after holidays spent amongst the W9's. OK is still heard on 56 Mc. QC finds it necessary to change his buffer stage due to the RK-23 deciding to quit. SR is trying to increase his 56-Mc. DX. UX is now installed at Rankin Inlet on Hudson Bay and operates on 14 Mc. under the call VE5AAY. AFK is building a new rig with 6L6's for 14 mc. The most important event of the last month was the Annual Hamfest held by the Winnipeg hams on June 27th at Tuxedo Park. The attendance was close to two hundred and fifty, representing the S.J.R.C., S.W.E.C., N.W.E.A. and W.R.C. Perfect weather, a fine sports program together with ham events ensured a successful outing, and all those present were enthusiastically in favor of a bigger and better outing next year.

Traffic: VE4AAW 3.

SASKATCHEWAN—SCM, Wilfred Skaife, VE4EL—RH, formerly of Winnipeg, is welcome addition to Saskatoon gang. QZ has to QRP for a while. ABN is new Saskatoon call. AEF, transferred to Halifax, will soon be on with VE1 call. AAA was put through its paces on Field Day and doubled contacts over last year's results. JB has new 14-Mc. 'phone with 53 crystal, T20 buffer, T55 final. BF spent nice time at Manitow Lake with his portable. MB has compact rack and panel with T55 incorporating rapid band changing. XB replaced P.P. '10's with T20's. UD is installing 6L6 P.P. doubler for more excitation on 28-Mc. 'phone. UH constructed 6A6-6L6 bi-push outfit. WF is active on 7 Mc. with '47, '53, T35. EF is new Weyburn ham with '47, '46. ES has new transmitter with 6L6-6L6-T20 and Q antenna. YC worked a Fiji Islander with 20 watts input. UL visited AT and admired his new 'phone rig. AT, UL and YC hold a weekly round-table schedule. BD, UQ, EL, UK and others of Regina gang do some experimenting on 56-Mc. 'phone. UK visited KV and other N. Battleford fellows. BR is now at Sioux Look-out, Ont. GA and ACR attended the hamfest at Edmonton. MD, new ham at Weyburn, is building self-excited rig. KM started out nicely with crystal P.P. 53-53 Bi-push, '10 driver, T55 final; modulator 57- 56- P.P. '45's and T20 Class B and then ran into modulation trouble. FW has gone to Vancouver to take special course.

Traffic: VE4CM 167 EL-WF 3 PQ 2.

NEW ENGLAND DIVISION

CONNECTICUT—SCM, Frederick Ellis, Jr., W1CTI—Traffic at AW was handled between June 16th and July 1st. BDI spent his vacation in Maine. KFN will have HF100 for net station. ITX at Essex is building a 28-Mc. 'phone rig. KJF dropped his pet crystal and like HYF's it cracked. KNT whistled CQ on Walnut Beach and raised MT from Sanford, Maine. DX! KKS can't get on the air until about 11 p.m. due to key clicks. JLL put in band switching. JBJ is rebuilding with a pair of '10's in final. JYJ went up for Class A. ES has a fine twice-weekly schedule with VE1IN, the Bowdoin-Kent's Island Expedition.

Traffic: W1JMY 105 AW 63 BDI-KFN 49 JXP 39 DMP 24 (WLGQ 33) BHM 22 ES 19 KJP 11 KNT 6 DWP 5 KKS-HPI 3 CTI 2 JLL-UE 1.

MAINE—SCM, Winfield A. Ramsdell, W1FBJ—CDX is back on the air from new location. EWN is new O.P.S. BDV is working portable at York Beach on 3.9-Mc. 'phone. KQX is new ham in Portland. KOH is spending the pleasant days working the new portable rig from the front lawn. GVS has new emergency outfit running six watts or less input into a Hartley '01A; power supply is a home-made vibrator, receiver has three 230's with 45 volts B. GE has taken his outfit to camp for the summer and is getting FB results on 7 Mc. PP has recently installed a 56-Mc. rig in his car. KJU is taking VE1IN traffic for Brunswick. HZJ is new O.R.S. KJJ is putting out a fine signal on the high end of the 1.75-Mc. 'phone band. KFI is new ham in Eastport. FCE is rebuilding the modulator in his rig, using 242A's in Class B and another pair in the Class C amplifier, which has an input of about 500 watts on 3.9-Mc. 'phone. QY plans to get back on the air soon. EZR worked his first K4 on 7 Mc. DHH is operating on 7142 kcs. GYZ has a pair of RK-20's modulated by a pair of tens, Class B, on 3.9-Mc. operating portable from a boys' camp near Fryeburg. ANR is operat-

ing portable from Oakland on 3.9-Mc. 'phone. We would like to get more news from the eastern and northern parts of the state. Just send in a little dope before the 20th of each month.

Traffic: W1GOJ 30 CDX 6 DHH 2 (May-June, W1HSD 17).

EASTERN MASSACHUSETTS—SCM, Albert N. Ciddis, W1ABG—KH visited VO3X in Labrador, JCK applied for O.R.S. HKK is touring the country with KBA. IIN is building 75-watt 'phone-c.w. rig for all bands. HKY is trying to snare Y12BA for W.A.C. IWV is rebuilding all transmitting apparatus into metal racks and panels. FZH is busy giving the gang frequency checks on 56 Mc. KQA expects to add an '03A to his 6L6G soon. We welcome 5CJB, O.B.S.—O.P.S.—T.L. and P.A.M. for Mississippi, into our Section. Don't forget to get your nominations in for a NEW S.C.M.! Yours truly is retiring to private life in order to pursue some pet experiments, build himself a station and bring his stamp collection up to date!

Traffic: W1AKS 168 (W1GO 99) KH 118 JNF 94 AMT 75 JCK 47 HKK 46 JTM 34 IIN 18 HKY 4 BEF 1 W5CJB 14.

WESTERN MASSACHUSETTS—SCM, William J. Barrett, W1JAH—IOR is covering the West. Mass. channel, 3732.5 kc. nightly from 5:30 to 6:30. AJ still schedules NY1AA; Ralph is rebuilding a unit at a time to keep rig on the air. GZL attended Worcester hamfest. KJK has two more rigs on the fire. BVR is working 14-Mc. c.w. and 1.8-Mc. 'phone with new Harvey UHX10. COI is working on bias supply for new rig. HJR is adding grid modulation to his "suitcase portable"; he operated portable from Cape Cod, with receiver, transmitter and power supply in suitcase. IPK sold 56-Mc. stuff and came back to 3.5-Mc. c.w. JOT is going to Mass. N.G. Camp at Falmouth. JOP will also be there, operating at Hdq. Co., 52nd Brigade. KOJ reports from portable QTH in Westminster. Fellows, we are faced with the necessity for planning and organizing for emergency work. Future disasters will call for something more than haphazard communication set-ups. In this connection, it is essential that we have complete and accurate information as to the equipment and personnel available in each community. Consequently I am asking YOU, INDIVIDUALLY, to drop me a card listing the emergency equipment you have available, and also where you can be reached quickly in case of need. Please take this appeal seriously. Floods, if they come, are right in our own backyard, so fellows, it's up to you. Have we the spirit to get right behind this thing? The next move is up to YOU, personally.

Traffic: W1IOT 17 IOR 21 AJ 13 DUZ 11 GZL 9 ISN 4 JAH 24 KJK 3 BVR 2 (W1G 46).

NEW HAMPSHIRE—SCM, Carl E. Evans, W1BFT—56-Mc. activity has been on the increase in this Section this summer. JSL reports working a W9 in Wisconsin on 56 Mc. and is proudly showing a QSL card in proof of it. JBA has installed a new beam antenna on 56 Mc. and is now contacting Massachusetts stations regularly. JDP has to move and will lose about 100 feet in altitude which may reduce his excellent 56-Mc. signal to some extent. CMB is building some 56-Mc. equipment which he hopes to take mountain climbing with him. ADR, Derry's pioneer 56-Mc. station, reports a new Junior Op. Congrats, OM. JCA, JNC, CPM, BHJ, COO and JQX are all very active on 56 Mc. OE wants to put his rod oscillator down to 120 Mc. if some of the gang will go down there with him. BFT is building up a new portable transmitter for 56 Mc. with an RK34 and 6L6 modulator. KPL and HXJ have a nice 56-Mc. set-up on Pack Monadnock; two matched impedance antennas mounted on 50-ft. poles with feeders right down to the road; just drive up and connect the feeders and operate in comfort from the car! KIN reports 2KHA vacationing in Hudson. IDY reports that the Farmers' Net had a most enjoyable get-together at Rye Beach on June 20th. EAL is operating portable on 14 Mc. from York Beach. FCI is anxious to line up fall schedules with Boston, New York, Philadelphia, Worcester and Springfield for handling ski and weather conditions from the north country; he wants schedules on 1.75-Mc. 'phone if possible. Anyone interested please get in touch with FCI. BAB has pulled up stakes and is now working for the A.T. & T. at Lawrenceville, N. J. DUK is now connected with the Mayflower Airlines, Inc., at the East Boston Airport. JHG is using a V beam on 14 Mc. trying to raise that elusive Asian. HOU is rebuilding and increasing power.

Traffic: W1FFL 53 (W1G 72) KIN 31 IDY 28 BFT 5. RHODE ISLAND—SCM, Clayton C. Gordon, W1HRC

—ETD, new O.R.S., rewound Ford generator for 110-v. a.c. portable supply. IZO has also rewound Ford generator. GTN went to Worcester Hamfest. IAV is spending summer at Nantucket. BVI is still on 56 Mc. JFF is experimenting with 56-Mc. receivers. HJ is back on the air at new QTH working good DX on 14 Mc. JNO is reduced to a '10 while rebuilding all-band crystal control rig à la BC. HRC is working with KQY in New Haven organizing an air club composed of A. T. & T. employees.

Traffic: W1IZO 5.

VERMONT—SCM, Alvin H. Battison, W1GNF—C.R.M.: IFSV, R.M.: 1EZ, P.A.M.: IAVP, AAJ attended the Boy Scout Jamboree in Washington. FSV is helping JKE build a new 14-Mc. transmitter. IRO's new QTH is 10 High St., Rutland. GAN is having trouble with his "C" bias pack. EZ received 589x from VP7FG on 3.5 Mc.!! GNF visited at 1HE and Cape Cod. JRJ is building a 60-Mc. transceiver. IQG is taking candid photos of the "gang." ELR has a new rack and panel transmitter using RK20, 35T, pair 35T's. BJP visited ATF. EMQ is on 3.9 Mc. IDM reports tube troubles in his 'phone transmitter. ATZ is observing quiet hours on 1.75-Mc. 'phone. AEN climbed Mt. Mansfield. IIV, The Twin State Radio Club, has purchased a new club house and is reorganizing. FSV has a new T55 transmitter nearly completed. GAE is busy with A.A.R.S. work. ATF is wiring his home.

Traffic: W1FSV-KJG 5 GNF 4.

ROANOKE DIVISION

NORTH CAROLINA—SCM H. S. Carter, W4OG—BHR has a new NC101X. EAM is rebuilding. ELY has received his W.A.S. certificate. AEL is studying for Class A and Broadcast licenses. DZS is now O.R.S., and is working on 7 Mc. CEL is about ready to go on 3.9-Mc. 'phone. ESB is doing fine on 1.75 Mc. ESO is on 7-Mc. band. DRU has an RME69 and a pair of HP100's. ESI uses an 807 crystal with about 40 watts input on 7 Mc. BRT is settled in his new location. CPT says his mother is improving, and he's able to put more time to radio. Here's hoping for her immediate recovery, OM. FT sticks to 28 Mc. EC sticks to 14- and 28-Mc. 'phone. W4BQZ has a pair of T-200's running 500 watts input. W4BPL has joined the Wilmington police force and will operate the new Police Radio Station. QI is looking for Asia, Africa and Utah. HI, DKF and DOR are on 1.75-Mc. 'phone. BYA received a card from DKI, who is having a big time in Washington State; from there he moves on to British Columbia, and will be back home about October. IY is in a new location with a pair of T55's. DGV schedules VP5AF each morning. CFR, ABT and BOH took a small portable rig to Farmers Fishing Camp near Sparta, and report working everything they heard on less than 20 watts input. DCQ has a new NC101X, and has his rig working on 14 and 28 Mc. with 500 watts input. BOH plans to be on soon with a brand-new rig. CYB, the new P.A.M. is experimenting with antennas. DKG is using low power but will have a pair of T55's soon. BDU was a visitor to CYB's shack; he is on 7 Mc. CPV has a c.w. on 14-Mc. 'phone doing swell. CDQ is on 7- and 14-Mc. O.S. AAU has an RME69.

Traffic: W4CVQ 16 NC 12 DZS 5 ESO 2 BYA 2 QI 1.

VIRGINIA—SCM, Charles M. Waff, Jr., W3UVA—GBC claims to be youngest Class A ham in the Division; he's 15 years old. 4DWB will be in Marion during summer. AIJ changed time for Va. 'Phone Net to morning and it works swell. EVN and BZE worked 9UVA; HI! GQP in Portsmouth is on 7 Mc. with 6L6G and 03A final. UVA is rebuilding to suit new QTH in Richmond. FMY is using PP 808's on 'phone and c.w. FBL has his new rig almost finished. BSY went to Europe for the summer. The Roanoke Division Convention will be held in Richmond, at the Hotel John Marshall, Sept. 4th and 5th. Tickets are \$3.00 and may be secured by writing 3FMY or 30GR. A grand get-together is assured. Be there! FUS is a new 'phone at Fort Story, Cape Henry. FHO gets out FB.

Traffic: W3FMY 10 4DWB/3 6.

WEST VIRGINIA—SCM, Dr. Wm. H. Riheldaffer, W8KKG—KLP is copying code for radiotelegraph second ticket. NCD and Charleston Radio Club ran up 1580 points in F.D. contest. KYJ received listeners card from U.R.S. KSJ is working traffic on 7290 Kc. 3FCM, ex W8-, is back from service at Panama and is on with QRP. NTV operated portable on Cheat River on July 4th with fine reports. OLV has station photo in O.R.S. Bulletin. MNX has a new Sky-rider. ELO is on 3506 kc. daily. AKQ attended Scout Jamboree at Washington. PAJ operated 3USA during Scout

(Continued on page 104)

Remember

ONLY UNTIL

AUGUST 31st

To take advantage of the special offer of membership-subscription and a copy of the 1937 edition of the "Handbook" for

\$3

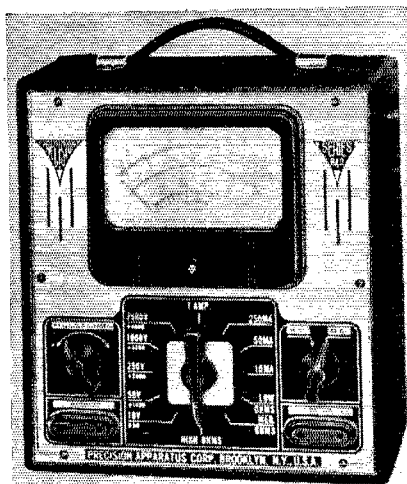

WRITE FOR DETAILS

on this new "PRECISION" test instrument . . . the Series No. 340 MULTIMETER . . . 2500 volts, AC-DC . . . a real asset to any ham shack . . .

PRECISION
APPARATUS CORPORATION

821 EAST NEW YORK AVE., BROOKLYN, N. Y.

102

The Fourth C.C.I.R.

(Continued from page 11)

centralizing administration, the designations for each range were in terms of wavelengths and there were no corresponding frequency term designations for the metric wavelength terms. In line with the long-established policy that "we ought to talk frequency," this went against the grain of the U. S. delegation, the Japanese and ourselves. So the fight was made to have frequency terms included in the table. In this the U. S. delegation led the way, with Colonel Crawford as spokesman, supported by Japan and the I.A.R.U. As the result, a fourth column was introduced in the classification table, designating radio waves according to frequency, as shown in the complete table reproduced herewith. Frankly, we are not entirely satisfied with this classification as it now exists and we are somewhat dubious as to whether it should be adopted for official use in *QST*. But it represents the best that could be obtained at the conference.

In addition to the strictly technical work of the conference, we also made every effort to further the amateur cause by taking advantage of every opportunity to cooperate in the general activities of the conference and by cultivating friendship and promoting sympathetic understanding of amateur radio. The ability of your Canadian representative (J. C. S.) in his use of the French language was of great value. It not only permitted a far wider cultivation of friendship and informal discussion with European delegates and conference officials, who all use French and rarely understand English thoroughly, but it also made his services valuable in an official capacity. Nominated as reporter of the important main committee on emissions by the U. S. delegation's chief, Dr. Dellinger, he served in this capacity keeping the minutes of all the meetings of this important committee. Further good will for the amateur cause was cultivated by his voluntary service as interpreter for two meetings of the International Broadcasting Union which were held outside the conference. In addition to cooperating at the daily meetings of the U. S. delegation, your American representative (J.J.L.) also aided in the general work of the conference by serving as reporter for the sub-committee on classification of radio waves. For this work both received expressions of personal appreciation, which were accepted as tributes to amateur usefulness.

In conclusion, it is our belief that I.A.R.U. participation in the Bucharest meeting of the C.C.I.R. served the intended purposes fully and contributed substantially to improving amateur conditions with reference to the forthcoming Cairo Conference.

I. A. R. U. News

(Continued from page 58)

Ceylon: Radio Club of Ceylon and South India,
P. O. Box 282, Colombo.

Building a New Transmitter? . . .

USE G-E PYRANOL CAPACITORS

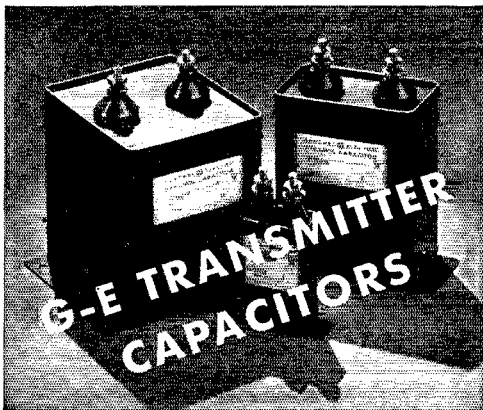

Be sure that your new rig contains G-E capacitors —because they will stand the gaff of hard service through long periods of use. G-E capacitors have these outstanding advantages.

1. They are all treated with Pyranol—a new General Electric synthetic material that assures permanence of their high dielectric strength and operating characteristics.
2. Every unit must pass a high-voltage test of double rated voltage. You can operate them continuously at 10 per cent above rated voltage.
3. They are hermetically sealed and leak-tested under vacuum.
4. They are very small in size, and fireproof.

You can get these Pyranol capacitors from your nearest dealer. For more information, write for Bulletin GEA-2021, Radio Dept., General Electric, Schenectady, N. Y.

360-120

GENERAL ELECTRIC

LOW PRICED! EASY TO ERECT! STEEL ANTENNA TOWER

HAMS!—Here's the ideal antenna tower—can also be used as a vertical radiator. Strong! Light weight! Extremely rigid! Comes in 20 ft. sections, with 5 ft. tip, knocked down, for building towers 25, 45, 65, 85, or 105 ft. high, as you wish. Easy to erect. Easy to climb.

Tower Legs— $\frac{1}{2}$ " x $1\frac{1}{4}$ " x $1\frac{1}{4}$ " x 20 ft. Low carbon rail steel angle. Galvanized after fabrication.
Cross Bars— $\frac{1}{2}$ " x $\frac{3}{4}$ " x $12\frac{1}{4}$ " mild steel, spot welded to form X brace. Baked black enamel.
Bolts— $\frac{1}{4}$ " USS x $\frac{3}{4}$ "—1035 steel, cadmium plated. **Guy Wire**—300 ft. No. 9 galvanized with each 20 ft. section. Tower weighs $4\frac{1}{2}$ lbs. per foot when assembled.

60^c
FT.
i.e.s. Sioux City,
Iowa

Order Direct From
WINSCHARGER CORPORATION
Dept. QST-9 Sioux City, Iowa

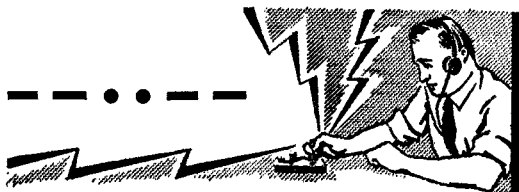

We Don't Mean to QUIT YOUR JOB!

. . . or to "sit-down" on the job either! We mean you had better get busy and prepare yourself for the bigger jobs in store for *technically-trained* men. Our one-year Residence School offers a concise, thorough training in Practical Radio Engineering, equipping you to enter the engineering field. Course begins Sept. 20 — write for details at once.

If you prefer to study by our home-study method, perhaps you can be one added to the remarkable percentage of 69% of our graduates who received better jobs after taking this training. A post card asking for our "Tested Plan" brings you 48 pages of interesting facts about radio and yourself.

Write Today for our 48-page Free Booklet "A Tested Plan for a Future in Practical Radio Engineering."



E. H. Rietzke, Pres.

CAPITOL RADIO ENGINEERING INSTITUTE

WASHINGTON, D. C. Dept. NEW YORK CITY
14th and Park Road Q-9 29 Broadway



NEW HOLDER DESIGN

15 SECONDS TO
INSTALL CRYSTAL

For All Bands
GREATER STABILITY
Plugs in 5 prong tube socket

Beautiful Appearance

MODEL AH HOLDER \$1.00 At your dealer or direct

HIPOWER LOW DRIFT CRYSTALS:

within 10 kc. or Choice of stock

AH-10, 1700-3500 Kc. bands \$2.35

AH-10, 7000-7300 " band 3.90

WRITE FOR NEW LITERATURE

Hipower "Low Drift" Broadcast and Commercial Crystals Are Approved by F.C.C.

Hipower Crystal Co., 2035 Charleston St., Chicago

(Continued from page 101)

Jamboree and sailed for Europe for international meeting. KWI worked three new countries in one day to bring his total to 82. KKG has new rotatable antenna with four elements. JRL is testing out mountains for new QTH.

Traffic: W8HD 2 PHY 5 OLV-NTV 1 KSJ 17 KYJ 3 PQQ 6 KKG 52.

HUDSON DIVISION

EASTERN NEW YORK—SCM Robert E. Haight, W2LU—CC erected antenna at new QTH. ALP is building 500-watt 28-Mc. 'phone rig. IWZ reports for Peekskill hams. New hams there: KMQ, KNR and KNT, who are all on 3.5 Mc. C.W. HYW is working for A.T. & T. in Netcong, N. J. HZF expects to join HYW there soon. JNK and FID are active on 56 Mc. KFB visited gang at A.R.R.L. Hq. JAX got 56 Mc. heard card from 9YGG. HEV applied for O.P.S. LU goes to Maine for vacation. ACB attended Glider meet in Elmira. Let's start the active season with a record number of reports. Send yours on the 16th. KBT gets \$7 from VK. JQS is camp counsellor.

Traffic: W2CC 7.

NEW YORK CITY AND LONG ISLAND—SCM, Ed. L. Baunach, W2AZV—KDS is out for O.R.S. FJH sends his first report. GQC is proud of his new Class A ticket. 3DQO is now located at Jerico. BVE and HBO did some active duty with the U.S.N. air reserve. HHW and HVD can be heard R.C.C. on 56 Mc. APJ is experimenting with radio conditions in the Hudson Valley on 56-Mc. portable. PF is taking 56-Mc. equipment with him to Camp Dix, N. J. KJP is also at Camp Dix C.M.T.C. BN bought a new shack in Brooklyn. IOF is moving to Schenectady. JDV has a new Super Pro. CBS is a fireman. JOZ was heard in the Philippines. GRB has a first class 'phone ticket. JTX got a Class A. LXJ is on 1.75-Mc. 'phone. HWS is working for R.C.A. at Riverhead. HGO is using variable crystal 7100 to 7112-ke. range. FF worked W10XDA, Schooner *Morrissey*, off Cape Race, Newfoundland, on 14,240-ke. 'phone. JHB took plenty of traffic from 3USA. JBL is operating portable at Lake Mahopac, N. Y. IHT is on bike trip thru New England. HMJ reports plenty of DX on 14 Mc. KAM received his R.C.C. cert. KIX is building a new rig with T20's final. EVA has thousands of foreign QSL's to be distributed. JEQ is spending the summer experimenting with rig. EYS spends most of his time rag-chewing. OQ schedules W1M on 3497.5 kcs. ELK rebuilt his rig. AZV has 56-Mc. rig installed in his car. INF is adding 242A final to his Gross 46 job. DBQ is making some PB meter scales.

Traffic: W2JHB 227 PF 125 INF 61 BGO 46 HGO 28 OQ 28 AZV 19 FF 18 HXT 15 HWS 4 CIT 4 KDS 15 AA 5 JBL 11 HMJ 8 HYL 5 DQW 4 DLR 3 HBO 2 ELK 1 (May-June, W2BGO 54).

NORTHERN NEW JERSEY—SCM, Fred C. Read, W2GMN—JUC is on 1.75-Mc. 'phone. IOZ is trying 28-Mc. 'phone. GZG has new 65-foot "A Frame" mast to support his 14-Mc. skywire. GYY lost pair of 66's when filament transformer arced through insulation. JOU is sticking 1.75-Mc. 'phone. JAB reports fine DX on 14 Mc. with his pair of 10's. GLH is getting places with 35T's. IAI has new 42-42 56-Mc. transmitter in his car. EKU is on all 'phone bands with pair of '46's in temporary rig. Plainfield Radiophone Ass'n will meet first Friday in September for election of officers and beginning of Fall meetings. The Public Service Radio Club, a group of hams, all of whom are employees of the Public Service Electric and Gas or Coordinated Transport Companies of N. J. will also meet about that time for their Fall dinner meeting in Newark. KIL, who reports for the first time, has 6L6 oscillator on 3.5 Mc. CHH is new member of the R.C.C. ICJ had 2½-hour QSO with ILE and is now also a member of the R.C.C. ILF worked his first YK. HXL is attending summer school at Rutgers University. JLY is on 28-Mc. 'phone. FTP is on 56 Mc. EKU has half a hole dug for a mast. KNY is new station on Maplewood. KKP is new station at Short Hills. Both are on 1.75-Mc. 'phone. CEE, on 1.75 Mc., is ex-W3CMI. HFB and his brother, KKO, have been taking time off the air to visit hams. GVZ worked Y12BA; he was also worked by BHW, CMY, IQG, and IVC who are located in the same town. ISZ is on 14-Mc. c.w. AOG is rebuilding for 28 Mc. GSI is working portable in 3rd district. HZY has been trying to work DX on 14 Mc. IYG has 300-watt grid-mod. 'phone rig on 1.75 Mc. KAL, a 1.75-Mc. 'phone boy, is building a new rig. KBF and KHR got in for lengthy rag-chews on 28-Mc. 'phone; a recent QSO lasted over 7 hours!

Traffic: W2GVZ 354 CGG 96 HNP 28 HZY 36 CMC 25 IZV 10 EKU 4 CJX 4 BCX 1 (W2HOZ 68, May-June).

ATLANTIC DIVISION

EASTERN PENNSYLVANIA—SCM, James M. Bruning, W3EZ—R.M.'s: 3AKB, 3AQN, 3EOP, 3ASW, P.A.M.: 3EOZ. As the term draws to a close your S.C.M. wishes to thank each one of you for the help you have given him during the past two years. It has been a pleasure to work with you. Let us continue our support so that our Section will maintain its enviable position. 3CGM took a trip to Colorado. 3CHH will soon be ready for O.R.S. ticket. 3GMK has been working on his 56-Mc. rig. 3EU has at last moved to the "perfect QTH for radio"; finding a nice farm equipped with "a.c." is something to crow about. 3GKF got a Class A ticket. 3GXX has been very active on 14-Mc. c.w. 3AQN has a new Silver Marshall receiver. 3DGC bought a Harvey 60X. 3GJY predicted in advance that Nevada would be his hardest state to QSO and he is still looking for it. 3EWJ attended C.M.T.C. at Fort Meade and met 8LEY and 8PCL there. 3BGD got an HF100 tube on the air after two months of low power caused by burn-out. 3BRZ received his bronze medal from the A.R.R.L. for the second highest Official Phone Station in 1936-1937 competition. He is quite proud of the medal, and I'm sure our Section is proud to have him in our area! 3ETM has moved to 7 Mc. until next season. 3ETA is still rebuilding. 3QP says 6CUU and KA1HR had to QRT their end of his circuit for about a month due to absence of signals out there on 7 Mc. 3EML has been taking the kinks out of his new super. 3AGK enjoyed a nice trip to Boston. 3CZS took time out during the hot months for a trip thru the New England States, including New York and New Jersey and, of course, ol' Penna. 3DXC has acquired quite a bit of experience building 6L6G oscillators. 3AKB enjoyed her vacation in the Adirondack Mountains of N. Y. 3EON wasn't satisfied with his home-made bug so he bought a Vibroplex; then to complete his station he laid up his 71A flea-power rig and bought a new 90-watt Utah. 8BQ sends in another full log of Official Observations. 3NF-3AMR again sends his report by Western Union. The Beacon Radio Club made over 1000 points on Field Day and only used 10 watts input on 3.5 and 7 Mc. That performance is what we call "Operating"! The Main Line Radio Club completed three of their seven scheduled transmitter hunts. The scores are neck and neck, but the four highest teams are, respectively, 3EZ, 3CGM, 3FRY, 3EOZ. The York Road Radio Club accepted the Main Line Challenge and will participate in the last four hunts. "The Clubs have started a-feudin' again."

Traffic: W3QP 137 ETM 61 (WLQF 10) DGC 49 NF/AMR 20 (WLML 406H) CHH 16 EDC 12 EML 7 BGD-EZ 6 GMK-GDI 4 AQN-GLQ 1 EWJ (WLQH 22).

MARYLAND-DELAWARE-DISTRICT OF COLUMBIA—SCM, Edgar L. Hudson, W3BAK—R.M.'s: 3CQS, 3EOU, 3CXL, Chief R.M.: 3BWT. FPQ operated portable at Boy Scout Camp Roosevelt with ASE. SN burned up 500-watt rig. EHW took part in the Field Day. EHP is entering the Naval Academy. Best of luck, "Broke." GEB has W.A.S. and W.A.C., both in less than a year after receiving amateur license. GAU has W.A.S.; since last November he has worked 65 countries and W.A.C. 7 times. EZN, DK and FSP are rebuilding. ER sold 60-foot lattice mast to EZN, who had good luck in erecting it in a difficult spot on a dock sticking out into the muddy old Potomac. But he had to take it down because he forgot to put the antenna halyard in the pulley! It's up again now. The following from EZN of the Washington Radio Club: The Washington Radio Club has formally asked that A.R.R.L. Convention in 1938 be held in Washington. CDQ is visiting in Europe. ZD is rebuilding using a pair of 250TH's in final. GXG was appointed Chairman by Washington Radio Club, furnishing operators for National Scout Jamboree. The main transmitters were furnished by U. S. Coast Guard with FKQ in charge of operations. Call letters were W3USA, power, 1 kw. Operators were: Chief op.: W2SN; W3FYG, W9ZAW, W8PBV, W5GAB, W8PAJ.

Traffic: W3CXL 141 (WLM 949) DQN 604 (WLMC 604) FPQ 279 SN 236 CIZ 38 EHW 6 BHE 1 USA 520.

SOUTHERN NEW JERSEY—SCM, W. W. Filson, W3BEI—DNU spent a little time at Camp at Indian Town Gap, N. Y. ZX's schedules are whittled down to weekly with Veronezh U.S.S.R., K4ENY and VE2LO on 14-Mc. 'phone. BEI has been busy with 56-Mc. portable transmitter for S.J.R.A. Field Day and Hidden Transmitter

hunt. The Atlantic Club is reorganizing in its new club rooms in the N.J.N.G. Armory in Atlantic City; with CYI Chairman of the meeting the following were elected: UT, Treas.; FML, Sec'y.

Traffic: W3BO 28 DNU 24 BEI 9.
WESTERN NEW YORK—SCM, Charles F. Smith, W8DSS—R.M.'s: 8JTT, 8BJO, 8AQE, 8CSE. P.A.M.: 8CGU. NWZ, who spent some time in a hospital having his appendix removed, was able to handle enough traffic to lead the gang. Nice work, Sam. QHX is after his W.A.C. KXA reports EBO has been reassigned his former call. PCW goes in for rag chewing. ABN and QDP are new O.R.S. with the latter running up a very fine score in the O.R.S. Party. Oneida was well represented in the "Name-It" Contest with BWY and CGU copping fourth and fifth prizes respectively. A new junior op. arrived at QGW. Friends may get their cigar by dropping around to his drug store. MMV passed the test for O.P.S. POL of Buffalo was back in his old home town (Oneida) visiting CPJ and DSS. The hamfest at the Marathon Country Club drew a large number of Central New Yorkers who enjoyed soft ball, golfing, bridge and a very nice dinner. There is some talk of having a W.N.Y. Traffic Net on 7 Mc. this season. Any amateur interested in this plan, whether O.R.S. or not, is requested to write Route Manager 8CSE of Tully at once so that steps may be taken to get the net functioning in time for fall traffic activities. Let's go. 73.

Traffic: W8NWZ 40 CSE 13 QHX 8 DSS 7 DHU 4 KXA 1.

1. WESTERN PENNSYLVANIA—SCM, Kendall Speer, Jr., W8OFO—R.M.'s: 8KUN, 8KWA, 8MOT. New O.P.S.: 8QNQ. Prospective O.R.S.—GSH, JSU. GUF goes B.P.L. this month on deliveries; he is working on summer trunk line consisting of KA1HR, K6NXD, W6IOX and SGUF. OFO is busy getting together plans for the coming season which consist of the W. PA. QSO contest, two O.R.S. nets and a 1.75-Mc. O.P.S. net. CMP is vacationing in the "wilds" of Michigan; he will return to State College in September. DGL visited 3USA, the Boy Scout Jamboree in Washington. IWD and MTJ have new junior ops. (Congrats.) KWA worked VE1IN, the Bowdoin-Kents Island station and handled some traffic with them. RG is operating 3.9-Mc. 'phone. QAN has been working some nice DX on 14- and 28-Mc. 'phone with half kw. input ONW got his Class A ticket. JSU is in the R.O.T.C. Coast Artillery training at Fort Monroe, Va. JAQ spends most of his time on 14 and 28 Mc. chasing XU's. QNQ is on 1.75-Mc. 'phone with a pair of T-20's in final, Class AB modulated. PTI is on 3.5-Mc. c.w. MWV was with the N.C.R. Aviation Squadron at Philadelphia for two weeks. The Valley Key and Mike Club held an outing with a nice turnout on June 20th. DRW has moved from Youngstown to Sharon. AG, DRW, LDM, QHS and MWV attended the Youngstown Hamfest. CJB is an airplane mechanic in spare time. QYJ has joined the N.C.R. AWW and LDM are going strong on 112 Mc. JSY, now a W4, returned to Miami, Fla., after spending two weeks with the gang around McKeesport. New hams: At Monessen, QWI; Farrell, QYU; Sharon, QLS.

Traffic: W8GUF 328 OFO 63 (WLQU 29) CMP 33 NDE 20 KUN 9 KOB 7 DGL 4.

Army Amateur Radio System Activities

(Continued from page 39)

was broadcast on November 11, 1936. In accordance with established practice the reception of this message was made competitive for all Corps Areas and departments and was won by Fourth Corps Area with 357 members copying.

6. *Test Emergency Messages.* These messages were mailed to A.A.R.S. members on October 21, 1936, to be transmitted to Washington. Object: training members for speed and accuracy.

7. *Flood Operation.* Ohio River Valley, January 23 to February 6, 1937. Oregon Emergency, January, 1937. Twenty-four hour operation by WLM.

MEMBERSHIP

(a) Active (c.w.)	995	
(b) Active (Fone)	156	
Total Active		1151
(c) Inactive (c.w.)	217	
(d) Inactive (Fone)	26	
Total Inactive		243
(e) Total A.A.R.S. membership	1394	

ZCB CONTEST, MAY 30-31, 1937

On May 30 and 31, 1937, a ZCB Contest was held by the A.A.R.S., results of which are shown

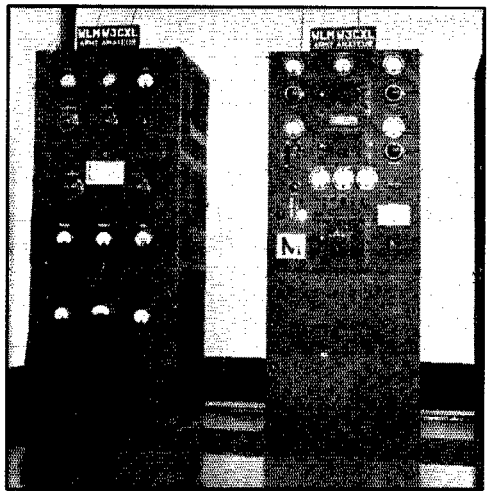

THE TRANSMITTERS AT WLM/W3CXL ARE LOCATED IN THE SPECIAL BUILDING THAT HOUSES OTHER WAR DEPARTMENT TRANSMITTERS, INCLUDING STATION WAR

in the following list. *Winning Corps Area:* Ninth, with 1710 points. *High Individual:* W8JKO of Sixth Corps Area with 131 points.

Corps Area	No. Participating	Total No. points	Worked All C.A.'s	High C.A. Individual	High Individual points
I.....	8	152	1	W1PI	38
II.....	14	486	1	W2DBQ	74
III.....	45	1634	6	W8MOT	115
IV.....	47	1162	2	W4NC (W4ABT-OP)	121
V.....					
VI.....	8	283	2	W8JKO	131
VII.....	41	1184	7	W9VBQ	104
VIII.....	25	663	2	W6KFC	108
IX.....	60	1710	0	W6CVL	96
OCSigO					
WLM/W6GXM	1	58	0		
WML/W3NF..	1	44	0		
WLM/W3GOQ.	1	46	0		
WLM/W3CXL					
(OP V).....	1	49	1		
(OP CB).....	1	39	0		
Totals.....	252	7510	22		

Canada—U. S. A. Contest

(Continued from page 49)

	Points	QSO's	Sections
2BZB	2997	37	3
2DZA	1296	18	4
2CW	378	7	3
2GVZ	72	2	2
IOWA			
W9CFB	11813	63	7
9TIJ	4536	29	6
KANSAS			
W9YAH	324	8	3
MISSOURI			
W9ULM	7087	38	7
9GBJ	6930	52	7
9RJP	5062	37	5
9AUB	4050	25	6
9VLP	3969	32	7
9FFR	864	12	4
9KEI	864	12	4
9ARH	810	9	5
NEBRASKA			
W9DMY	3412	27	7
CONNECTICUT			
WITS	7623	63	7
IGME	792	11	4
1JFN/1	729	14	2
1EH	450	5	5
1JUD	144	4	2
1AW	144	4	2
1JTD	72	2	2
EASTERN MASSACHUSETTS			
WIRY	7119	59	7
1ABG	2025	25	3
IIVX	27	1	1
NEW HAMPSHIRE			
W1BFT	7875	65	7
IIVU	4752	44	6
RHODE ISLAND			
W1BBN	5040	40	7
1DIL	2565	29	5
1JUE	432	8	2
MONTANA			
W7EWR	1701	38	3
OREGON			
W7AOL	9828	52	7
WASHINGTON			
W7ECX	2430	34	3
7DLN	1620	15	4
7FLK	1575	18	5
HAWAII			
K6CGK	648	12	3
SANTA CLARA VALLEY			
W6HJT	9072	72	7
EAST BAY			
W6ITH	12726	101	7
SAN FRANCISCO			
W6NEN	2565	19	5
6JMR	2052	19	6
6MCU	1296	12	4
6CIS	900	10	5
SANCRAMENTO VALLEY			
W6OFD/6	4941	30	6
6GVM	3150	27	7
6IZE	2818	26	6

Sealed in glazed porcelain containers the Type 86 MICA TRANSMITTING CAPACITORS are ideal where high frequency, high voltage conditions are encountered. A few of the salient features are:

- Accurate and constant capacity • Field absorption prevented by glazed, dehydrated ceramic case • Constructed under exclusive Dubilier patent feature eliminating all corona effects.

Available in a complete capacity range from 2,000 to 12,500 volts. Catalog No. 137A free on request.

CORNELL-DUBILIER
ELECTRIC CORPORATION
South Plainfield, New Jersey

Remember

Only until August 31st

To take advantage of the special offer of membership-subscription and a copy of the 1937 edition of the "Handbook" for

\$3

SPEED-X

The Complete Line of Telegraph Keys

A hi-grade practice set using a Speed-X Hi-Frequency Buzzer and a special designed full size manual key fully adjustable. All metal parts Nickel Plated and Mounted on a genuine Walnut Bakelite base, includes International code plate.



No. 450 Practice Set
List \$3.25

Operates on 3 to 6 volts for practice work or two way communication.

Available at leading jobbers everywhere—write for new literature and amateur discounts

LES LOGAN CO.

646 Jessie Street

San Francisco



31 CHECKS and INSPECTIONS

ASSURE CERTIFIED CRYSTAL CONTROL

The activity, power output and general all-round reliability of Bliley Crystal Units don't just happen. From the very first piece of raw Brazilian quartz until the finished mounted crystal is packed in its box, over 31 different checks are given each unit. Precision optical, mechanical and electrical equipment test, check and re-check the work of skilled Bliley craftsmen in each succeeding step of the manufacturing process.

That's why Bliley Crystal Units are universally accepted without question for Certified Crystal Control. That's why more and more amateurs are turning to Bliley LD2 Units for all-round crystal requirements in the 40-80-160 meter bands. Your distributor has them in stock for \$4.80.

BLILEY ELECTRIC CO. ERIE, PA.

BLILEY CRYSTAL UNITS

\$100 for a RADIO KEY!!?

WORTH IT, but I only charge \$9.50

No "hokey" about it. This semi-automatic key really steps up your speed. Dot-stabilizer equipped — most remarkable feature ever offered! Main spring Swedish steel, tensioned and balanced. Case-hardened pins and screws. Bakelite used throughout — no fibre. Big solid base stays put. Rich Marblette finish. Metal parts chrome plated. Proper height for tireless rhythmic sending. Order your new 1938 De Luxe Model MAC key today! Only \$9.50.

MAC Oscillator, \$4.50. Also New MAC Straight Key, the best there is — only \$2.50. Write for complete dope on other MAC items of tremendous help to radio ops. Immediate delivery on every thing!

**T. R. MCELROY—175 Congress St., Boston, Mass.
WORLD'S CHAMPION TELEGRAPHER**

LEARN CODE RIGHT

Tapes for Every Need — Even Airways —
Send You Typical Messages by
INSTRUCTOGRAPH

It's easy and practical to learn or improve your Radio or Morse Code, any speed. Senior model with 10 tapes and Book of Instructions — \$20.25. (Rented at low cost) Junior model with 5 tapes and Book of Instructions — \$12.00. (Not rented). Complete oscillator equipment, less battery, \$6.50. Write for details today.

INSTRUCTOGRAPH CO., Dept. Q-9
912 Lakeside Place Chicago, Ill.
Radio College of Canada
863 Bay St., Toronto



WE ALSO HANDLE: HALLIGRAFTER AND R.M.E. SHORT WAVE RECEIVERS — MICROPHONES — VI-BROPLEXES — TAYLOR TUBES . . . CASH OR TERMS



Look Fellows!

Doll up your rig with this attractive metal plate with your call letters. Raised letters bright finished on black oxidized background. 16 guage metal. Overall size 6x1½". Postpaid in U.S. on receipt of \$1.00. Foreign countries \$1.20.

CALL LETTER PLATE CO.

W4AEE — W4EVE

134 4th Avenue N. • Nashville, Tenn.

BRAZILIAN QUARTZ CRYSTAL

Largest and most varied stock of Brazilian quartz crystals in the United States. Finest quality suitable for manufacturing piezoelectric crystals, lenses, and prisms. Shipments received regularly from our Brazilian Branch. Also in stock tourmalines for making crystals to control the higher frequencies and quartz for fusing purposes.

BRAZILIAN TRADING CO., INC.

377 Fourth Ave., New York City Murray Hill 4-2891

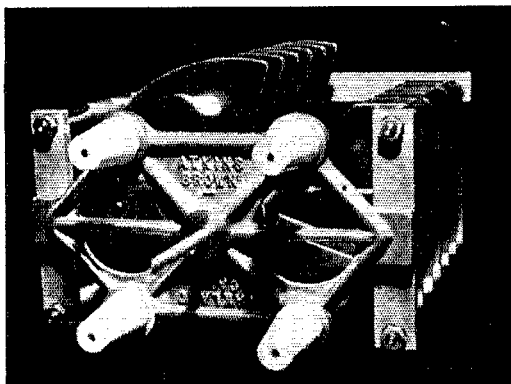

Split Stator — 50-50 mmfd.
Peak v. 16,000 — Airgap half inch
DEPTH BEHIND PANEL ONLY 9 $\frac{3}{4}$ INCHES

Outstanding as a quality product — this 90° type of condenser will be brought to you by a new firm whose founders are old in amateur and commercial radio.

Prices and delivery date to be announced

ATKINS & BROWN
W 6 V X W 6 H B
215 14th STREET, OAKLAND, CALIFORNIA

No. 1 ON THE HIT PARADE

The Meissner All-Wave Tuning Assembly is the entire "front end" of the radio receiver. Each unit is completely wired and accurately balanced and aligned. **READY FOR USE.** Only six wires to be connected to any 456 kc I.F. channel.

Meissner

TUNING ASSEMBLY

1. All-Wave (no skip) 5 to 555 meters (540 kc-60mc).
2. Meissner Multi-Wave 5-Band Coil assembly; Individual coils for each band; Meissner Align-Aire trimmers thru out, six-gang shorting switch; fully shielded.
3. Meissner three-gang tuning condenser; low minimum capacity.
4. Modern 8-in. oval dial; two-speed control; calibrated 5-Band scale; scale for Band Spread.
5. Compactly mounted on rigid cadmium-plated steel chassis.
6. All components including all resistors, by-pass condensers, coupling condensers and AVC network.
7. Every unit laboratory tested and completely aligned and padded.

NOTE: See your dealer for our New 32-page descriptive catalog

MEISSNER MFG. CO.
Mt. Carmel Illinois

	Points	QSO's	Sections
SAN JOAQUIN VALLEY W6MVK	12285	65	7
NORTH CAROLINA W4CFR	1350	10	5
VIRGINIA W3FQP	2430	27	5
3FZG	2322	22	6
3GTS	2160	24	5
3EXW	72	2	2
COLORADO W9YAD	7843	42	7
9FFU	4104	38	6
9TSQ	288	4	4
9ZDZ	108	2	2
UTAH-WYOMING W6FRN	2394	19	7
EASTERN FLORIDA W4DIQ	1188	11	4
LOS ANGELES W6BXL	4851	40	7
SAN DIEGO W6KBD	4032	32	7
6ITY	2928	28	7
6GTM	698	6	4
NORTHERN TEXAS W5DQD	6048	48	7
5CPT	2873	18	6
OKLAHOMA W5FLU	2646	25	6
SOUTHERN TEXAS W5FZD	5607	31	7
5DAW	648	8	3

RESUME

The Marconi Cup donated by the Canadian Marconi Co., Ltd., of Montreal for the highest scoring Canadian Station goes to VE3GT, S. B. Trainer, Jr., Toronto, for score of 34,807. He also gets a 203A donated by the Canadian General Electric Co., Ltd., Toronto.

Second prize is taken by VE3IR, R. S. Rennie, Agincourt, Ont., with a score of 28,665, a 203A donated by Canadian Westinghouse Co., Ltd., Hamilton, Ont.

Third prize, a pair of 801's, donated by R.C.A.-Victor Co., Ltd., Montreal, is won by VE3JT, Frank Hartley, Toronto, Ont., with a score of 22,172. Fourth prize, a set of Rogers receiving tubes, donated by Rogers-Majestic Corporation, Ltd., Toronto, is won by VE5QP, M. C. Brooke, Eburne, B. C., with a score of 20,800.

Fifth prize, a \$5.00 credit note, donated by the Canadian Tire Corporation, Toronto, is won by VE4QZ, C. F. Sawyer, Saskatoon, Sask., with a score of 19,800.

In fairness to the contestants who mailed their logs prior to midnight, April 30th, which was the deadline, the following logs are acknowledged but not entered in competition—VE3AET, VE5NK, W1KLR, W1NA and W6MZH. The Philippines and New Mexico sections are the only ones that do not appear to have had many participants. The remainder of the sections not showing logs submitted were each worked a number of times. For next year's contest please let the committee have logs from all sections as it makes checking so much easier. No matter what your score may be, it is just possible that you may be eligible for the Section Certificate.

A.R.R.L. has April of each year in mind for this contest. We hope to see you again next April.



Can you qualify for the DX Century Club? See page 59. Get your cards together and shoot them along.

CELEBRATING OUR FIRST ANNIVERSARY



Won't you join us?

NATIONAL 80X In Stock

The NC-80X Receiver, ten tubes, crystal filter, controllable selectivity from 200 to 10,000 cycles, automatic coil shifting, complete frequency coverage from 9 1/2 to 600 meters. Self-contained power pack, PM speaker, calibrated mechanical bandspread. Complete with tubes, crystal and speaker chassis. Net. \$88.00

NC-81X, same as above, but a strictly amateur-band model, providing extreme calibrated bandspread. Complete with tubes, crystal and speaker chassis. Net, \$88.00

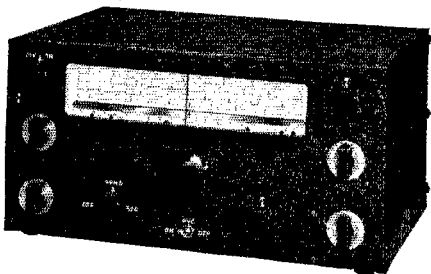

THORDARSON SPECIALS! PLATE TRANSFORMERS

Shielded cases — tapped primaries air-cooled construction — Porcelain Terminals — 115 volts 60 cycle primaries

T-16PO0	D.C. volts 650 or 500 @ 200 ma. Net Price \$3.96
T-16PO1	D.C. volts 1250 or 1000 @ 300 ma. Net Price \$7.80
T-16PO2	D.C. volts 1250 or 1000 @ 500 ma. Net Price \$12.60
T-16PO3	D.C. volts 1800 or 1450 @ 300 ma. Net Price \$11.40
T-16PO4	D.C. volts 2500 or 2000 @ 300 ma. Net Price \$13.95

CHOKES INPUT

T-16C20	5-20h — 200 ma — 2000 v ins. Net Price \$2.25
T-16C21	5-20h — 300 ma — 3000 v ins. Net Price \$3.00

SMOOTHING

T-16C25	12h — 200 ma — 2000 v ins. Net Price \$2.25
T-16C26	12h — 300 ma — 3000 v ins. Net Price \$3.00
T-16C27	12h — 500 ma. — 3000 v ins. Net Price \$5.40

FILAMENT TRANSFORMERS

All have high current ratings — center taps — 2000 v insulation. At rock bottom prices!

We've grown to such sturdy proportions for a one-year old, that we can't help boasting about it. And while we admit that this condition is partly due to our policy of "Service and a Square Deal," we realize that it could not be possible, were it not for the large number of "Hams" who are keen enough to recognize that Terminal is a good place to shop for radio supplies. To those who have already "discovered" Terminal, and to those who during our next year will join our growing family of satisfied customers, "THANK YOU!"

Bill and Adolph

HARVEY 80-T X'mitter

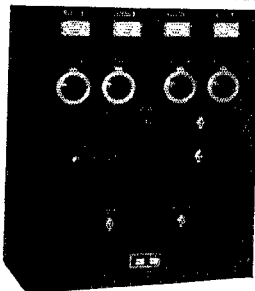

- All Band coverage on phone and CW.
- Complete — Compact — Well built
- Reasonably Priced

Write for information — we are EXCLUSIVE
N. Y. HARVEY DISTRIBUTORS

MASONITE PANELS

Black or Grey Crackle Finish
Light — Strong — Easy to drill

PANELS LISTED BELOW FIT STANDARD 19" RACKS. MOUNTING HOLES DRILLED.

1 3/4" \$.36	12 1/4" \$1.23
3 3/4"48	14 " 1.41
5 1/4"54	15 3/4" 1.71
7 "69	17 1/2" 1.89
8 3/4"87	19 1/2" 2.07
10 1/2" 1.05	21 " 2.25

ALSO IN STOCK — METAL RACKS AND PANELS



FLASH! Two new beam power tubes by RAYTHEON. Less than two watts drives these tubes!

Type	Output	Net Price
RK-47	100W.	\$17.50
RK-48	230W.	27.50



Complete stock of Thordarson wired amplifiers — from 6 to 60 watts — on demonstration. Come in and hear them — we have speech equipment for every transmitter requirement.

TERMINAL RADIO CORP.

80 CORTLANDT ST.
BILL FILLER

NEW YORK, N. Y.
ADOLPH GROSS

Hints and Kinks

(Continued from page 52)

mitter.) Tap and input capacity are adjusted for minimum harmonic. Bucking may be obtained at some degree with the tap misplaced, but the point is to find the tap for which most complete cancellation is obtained. This will be such that the tuning for the pi-filter will be normal except that the adjustment of the input condenser will be critical and while this is the position of minimum plate current the plate current meter does not reveal the exact point.

In making tests over the air I found that with the network properly adjusted according to plate-current minimum the harmonic (second) could be heard. This was in test with W4KT in Thomasville, Ga. Immediately after the test was made at a distance of $\frac{3}{4}$ mile on a sensitive broadcast receiver connected to a spider-web antenna. Before bucking was applied, but using electrostatic shield and inductive coupling between plate tank and pi-filter, the harmonic was S7 to 8 and clearly modulated. When bucking was employed this harmonic could not be heard at all with full gain. At the same time, numbers of amateur harmonics from out of town could be heard plainly. This test was repeated and verified. When bucking is employed the strength of the second is about 50 microvolts as measured by the receiver when connected to its normal antenna. At this sensitivity setting some distant stations come through. It appeared that the harmonic could be bucked below the value of the driver harmonic alone (actually about 40 microvolts), but I am not certain about this although it was twice noted. When the second harmonic is thus cancelled out, the third measures into thousands of microvolts with the receiver in this position (within 4 feet of the transmitter) but as a matter of fact, the third is very low at any considerable distance. This gives an idea of how low the second is really pulled down.

—J. D. Blitch, W4IS

Variable-Frequency Crystal Holder

THE experience of being told that some other station is transmitting on the same frequency you are, or near enough to heterodyne badly, is of course one of the commonest among amateurs. While the operator of a transmitter which is not crystal controlled may have a certain advantage in being able to shift his frequency at will, few of us wish to sacrifice the advantages of crystal control, especially on the higher frequencies. Having several crystals is of course a help, but quite often a number of them may be tried without finding a satisfactory spot. There is also the likelihood of some other station being unable to find the carrier again after a shift.

The variable-frequency crystal is obviously the answer to this problem, giving the stability of crystal control yet allowing a sufficient shift of frequency to clear other carriers. The frequency



YOU GET THRU with a 70SW

For clear, crisp, powerful signals that get you through, use the new Shure 70SW — the "Communications-Type" Microphone that is rapidly being adopted as the new standard by many Airlines, Police Radio, Commercial and Amateur stations. The 70SW gives you all the advantages of the famous Shure 70S — plus 5 db higher output! Requires only 56% of the amplification previously needed.

Model 70SW, complete with desk mount and cable, only..... **\$25**

See your Jobber or write for Bulletin 144QW today!

Ask your Jobber to show you the new Shure "Military-Type" Hand Microphone — entirely new design — no bothersome handles — fits naturally in palm of hand.

Shure patents pending. Licensed under patents of the Brush Development Company.



SHURE BROTHERS
225 W. MURKIN ST., CHICAGO, U.S.A.
CABLE ADDRESS: "SHUREMICRO"
MICROPHONES & ACOUSTIC DEVICES

INTRODUCING



Glassmike

"A FIXED CONDENSER THAT STAYS FIXED"

KEEP that rig of yours on the air! Don't let condenser breakdown interrupt an important Q S O! Here's a "glass walled" by-pass condenser that's absolutely impervious to moisture, guaranteed for a year, that will free your rig of condenser trouble from now on. It's absolutely new and different in construction, and costs no more than an ordinary condenser. Ask for Glassmike!

ASK YOUR JOBBER TO SHOW YOU "GLASSMIKE"

CONDENSER PRODUCTS CO.
1369 NORTH BRANCH STREET
CHICAGO • ILLINOIS

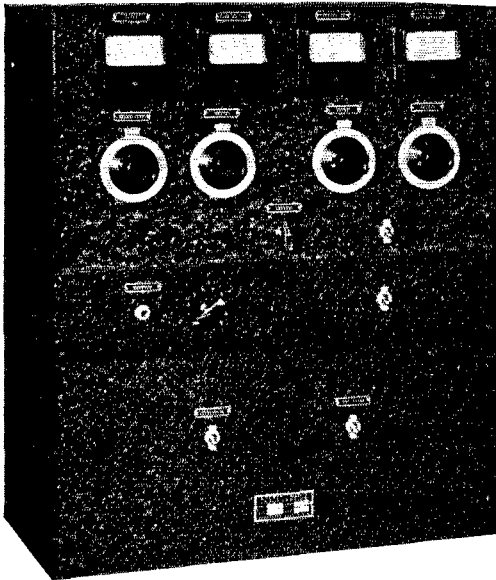

80-T TRANSMITTER

- Covers all bands from 10-160 meters on phone and cw.
- Has all necessary controls and meters, yet is simple to operate.
- Compact in size and well proportioned for restricted space.
- Reasonably priced and may be purchased on easy payments.

YOU PROTECT YOUR INVESTMENT

when you buy an 80-T transmitter because it becomes the foundation unit for our 700-R transmitter when higher power is later desired. We allow you the full purchase price of your 80-T when the larger transmitter is purchased, thereby eliminating any depreciation on your initial investment. This feature alone is well worthy of your consideration.

Write For Information And Prices

HARVEY RADIO LABORATORIES, INC.

12 Boylston St., Brookline, Mass.

Export: 25 Warren Street, New York City.

Cable: "Simontrice"

R. R. Jobs for CW MEN

65 TO 80c PER HOUR. YEAR AROUND

R. R. Pension Making Hundreds of Vacancies. Learn Train Traffic System and Morse Through our Course and Qualify for Job in 4 Months. Time Payments if Desired. Ages 18 to 35.

CODE-CRAFT CLEVELAND, OHIO
6703-Q Dunham Ave.

SPECIAL TO AMATEURS

Piezo-Electric Crystals — \$2.50 EACH POSTPAID

Until supply is exhausted . . . we offer small 80 meter band crystals unmounted; accurate calibration, excellent oscillators. Limited quantity.

SCIENTIFIC RADIO SERVICE

"The Crystal Specialists Since 1925." University Park, Hyattsville, Md.

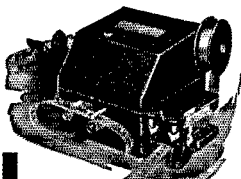

At Last!
A Perfected
**AUTOMATIC
SENDER**

Save your list. Let the Automatic Sender raise your stations for you. Repeats calls or messages indefinitely. Length of messages unlimited. Sends from 2 to 70 words a minute. Motor driven. Entirely automatic. Built-in tape perforator. Absolute uniformity in spacing of characters. Used with buzzer or oscillator, makes excellent code teacher for novice and speed-builder for the advanced amateur. Complete with 4 rolls of tape and full instructions. No extra equipment needed. If your dealer can't supply you, write us.

only
\$12.50

Postpaid
in U. S. A.

Patent
Pending

Gardiner-Levering Co. Haddon Heights
New Jersey, U. S. A.

MONEY-BACK GUARANTEE

READ AND SEND

CODE

Learn Easily at Home this Quicker Way:

No experience needed. Beginners read code quickly, copy accurately. If already an op, speed up your wpm this approved way. "Almost human!" experts call the amazing New All

Electric Master Teleplex. Only instrument ever produced which records your sending in visible dots and dashes on specially prepared paper tape — then sends back your own key work at any speed you wish.

Fascinating, fool-proof, gets results because you learn by HEARING as well as seeing. That is why thousands agree this method is surest and quickest. We furnish Complete Course, lend you the New Master Teleplex, and give you personal instruction with a MONEY-BACK GUARANTEE. Low cost, easy terms. Write today for folder Q9; no obligation.

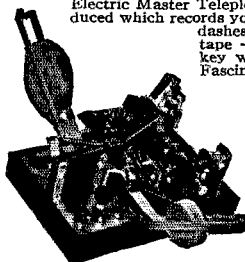

The "Ham" Standard Teleplex — a highly efficient codeteacher using heavily specially prepared waxed paper tape, having two rows of perforations. Write for Free folder QT-9.

We are the Originators of this type Instrument

TELEPLEX CO. 72-76 CORTLAND ST.
NEW YORK, N. Y.

RADIO ENGINEERING



RCA Institutes offer an intensive course of high standard embracing all phases of Radio. Practical training with modern equipment at New York and Chicago schools. Also specialized courses and Home Study Courses under "No obligation" plan.

Illustrated Catalog on request

RCA INSTITUTES, INC. Dept. ST-37

A Radio Corporation of America Service

75 Varick St., New York

1154 Merchandise Mart, Chicago

Say You Saw It in QST — It Identifies You and Helps QST

15 Years Ago . . .

WHEN the Radio Industry was still a lusty, howling infant, Sun Radio was founded upon the principle that "He profits most who serves best." In the succeeding years we have never deviated from our original promise to SERVE; to give just a little Extra in value or personal attention. It is not to be wondered at, therefore, that many of our first customers are still our best friends.

TODAY

A new generation of Hams and Experimenters is growing up and Sun radio is proud of the fact that because of a reputation for reliability and service built through the years, these men come to us to fill their every requirement.

This Month SUN SHINES on THE NEW NATIONAL NC80-X

Ten tubes, Crystal Filter, Controllable Selectivity, Automatic Coil Shifting, Complete Frequency Range from $9\frac{1}{2}$ to 6000 meters. AC or DC operation, PM Speaker. Our price complete with tubes, speaker and crystal. Net. . . . \$88.00

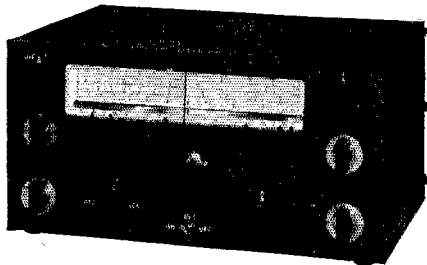

The NEW TAYLOR T-125

Taylor's latest development. Net. . . . \$13.50
All other Taylor Tubes in stock. Write for Free 40-page handbook.

SUN'S BEST BUYS OF THE MONTH

- Stancor's newest modulator unit using Taylor T20 Tubes. Free blueprint and layout template. Complete transformer kit \$12.21
 - SPECIAL BARGAINS IN METERS!
Metal Case Panel Mounting 150 v. Ac; $3\frac{1}{4}$ " diam. . . . \$3.75
Bakelite Case Panel Mounting, 3v. Ac., $3\frac{1}{4}$ " diam. . . . \$2.95
Bakelite Case Panel Mounting, 5v. Ac., $3\frac{1}{4}$ " diam. . . . \$2.95
Bakelite Case Panel Mounting, 2 MA DC $3\frac{1}{4}$ " diam. . . . \$3.45
All Meters New — Limited Quantities
 - Jewell Semi-Portable Meters, 1000 ohms per volt triple range, $7\frac{1}{2}$ —300—750 volts DC. \$4.95
 - Keying Relays, 2½—6 volts AC and 6 volts d.c. Ea. . . \$1.62
 - New 1938 Super Skyriider in Stock. Write for Free catalog and time payment plan. Liberal Allowance on old receiver.
 - Sylvania 211 C. Can replace 211, 203A, 242A. Brand new and guaranteed. \$6.75
 - Electronic Converter, 6 volts d.c. input; 300 v.—100 ma. output. Ideal for portable equipment. Net. \$13.23
 - Stancor Plate Transformer, 750, 1000 volts at 300 MA. Net. \$5.75
- Our monthly bulletins list "unadvertised Bargains" and latest dope from manufacturers on their new ideas. A postcard addressed to Dept. Q9 will bring it each month.

RADIO CO.

227 Fulton Street, New York, N. Y.

Cable Address: SUNRADIO NEW YORK

change may be made while operating the transmitter, thus allowing the other operator to follow along on the receiver. Any adjustment of the tuned circuits is usually unnecessary.

However, variable frequency crystal assemblies are relatively expensive, and it is the purpose of this discussion to describe how an ordinary holder may be converted into such a unit, or at least how one may be acquired at little more than half the price. The first requisite is an 80-meter crystal of the low-drift type. An X- or Y-cut will not do, and the crystal must be a "hot" one so that it will oscillate satisfactorily with an air gap, the varia-

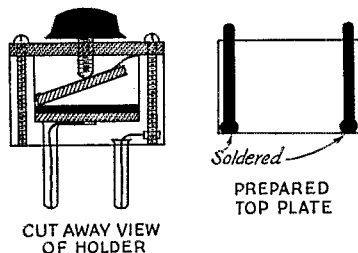

FIG. 5—VARIABLE AIR-GAP HOLDER MADE FROM A STANDARD PRESSURE-TYPE HOLDER

tion in the gap determining the frequency—the more gap the higher the frequency. A normal variation of 6 kilocycles on the fundamental may be had with good stability, which will give 12 kilocycles on 40 meters, 24 on 20 meters, and 48 on 10.

A number of designs may be used in making over the holder. The top plate may be fastened to an adjusting screw which raises and lowers it above the crystal. One of the best and simplest however is the "hinge" type in which one edge of the top plate is always against the crystal, the opposite edge being raised and lowered to vary the gap. This holds the crystal firmly and allows operation in any position. As a typical case the conversion of a Bliley LD2 unit will be described in detail.

First disassemble the holder, removing the top plate, the two contact plates and crystal, and the coil tension spring. Solder a wire to the center of the bottom plate and insert the end of the wire through the terminal pin, soldering at the tip. This gives a solid bottom contact plate for the crystal. The top contact plate should be prepared by cutting two strips of thin spring brass about $\frac{1}{8}$ -inch wide and $\frac{1}{8}$ -inch longer than the width of the plate. These are soldered on to the plate parallel to each other at two corners, the free ends extending the $\frac{1}{8}$ -inch beyond the opposite edge of the plate, as shown in Fig. 5. Two small bits are cut away in the inside corners of the bakelite frame so that when the plate is slipped in, the two overlapping strips will hold the one edge up and yet will be sufficiently recessed so as not to be clamped when the top disc is screwed down. There remains but to drill a hole through the circular top plate, thread it to take the adjusting screw and reassemble the unit. If a $\frac{1}{4}$ -inch screw

NEW SIZE METERS

These new Hoyt meters are designed for all standard panels and measure $3\frac{1}{2}$ inches across the flange and fit a $2\frac{3}{4}$ inch panel hole. The 582 D. C. is a jewel-bearing, moving-coil instrument and has the same rugged construction for which all Hoyt meters are noted. Accuracy is 2%. The 584 A. C. has a standard repulsion movement pneumatically damped. The case is the same size as the 582 and both models are supplied with insulated zero adjusters.

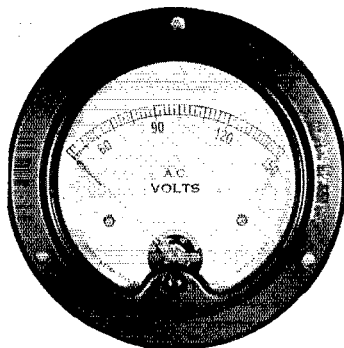

NO. 584

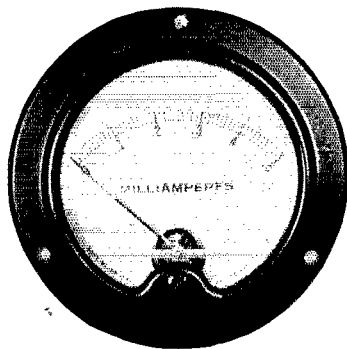

NO. 582

These are only two of the meters described in the new Hoyt catalog which is just off the press. Send the convenient coupon below for your copy and learn how inexpensively you can fit your panel with time-tested Hoyt meters.

THE BURTON-ROGERS CO.
 755 BOYLSTON ST. BOSTON, MASS.
 SALES DIVISION OF THE HOYT ELECTRICAL INSTRUMENT WORKS

Gentlemen: Kindly send me the New Hoyt Radio Meter Catalog.

Name

Street

City State

RECEIVER SENSATION OF THE YEAR! THE 1938 SUPERSKYRIDER!

If possible drop in our store and hear this remarkable receiver. Send for descriptive booklet.

Time Payments on All Hallicrafters Receivers

NEW THORDARSON SPECIAL POWER TRANSFORMERS

- T16PO-0. 640-810 V. each side at 200 MA, WT. 9 lbs. \$3.96
- T16PO-1. 1220-1510 V. each side at 300 MA, WT. 23 lbs. 7.80
- T16PO-2. 1250-1540 V. each side at 500 MA, WT. 36 lbs. 12.60
- T16PO-3. 1740-2140 V. each side at 300 MA, WT. 31 lbs. 11.40
- T16PO-4. 2370-2950 V. each side at 300 MA, WT. 39 lbs. 13.95

Send for New Thordarson Catalog

A JOHNSON "Q" IS A BETTER ANTENNA

- 5Q. Five meter antenna system \$3.83
- 10Q. Ten meter antenna system 3.67
- 20Q. Twenty meter antenna system 5.82

JEFFERSON SPECIAL FILAMENT TRANSFORMERS

- 6.3 V. @ 4 Amps. 1600 V. Insulation \$1.32
- 7 1/2 V. @ 6 1/2 Amps. 2000 V. Insulation 1.76
- 10V. @ 7 Amps. 5000 V. Insulation 2.35

We usually have some receivers on hand that have been taken in trade on new sets. If you are looking for a used job it might pay you to see us.

KENYON SPECIALS

POWER TRANSFORMERS

- D200. 750-1000 V. each side at 300 mils. Net \$5.25
- D201. 1000-1250-1500 V. each side at 300 mils. " 6.80
- D202. 1500-2000-2500 V. each side at 300 mils. " 11.00
- D203. 1000-1250-1500 V. each side at 500 mils. " 11.00

SMOOTHING CHOKES

- D100. 20 Henries — 200 mils. 2500 V. insulation. Net \$1.50
- D102. 20 Henries — 300 mils. 2500 V. insulation. " 2.90
- D104. 20 Henries — 400 mils. 5000 V. insulation. " 3.50
- D106. 20 Henries — 500 mils. 6000 V. insulation. " 5.00

SWINGING CHOKES

- D101. 5-25 Henries — 200 mils. 2500 V. insulation. Net \$1.50
- D103. 5-25 Henries — 300 mils. 2500 V. insulation. " 2.90
- D105. 5-25 Henries — 400 mils. 5000 V. insulation. " 3.50
- D107. 5-25 Henries — 500 mils. 6000 V. insulation. " 5.00

IF You are in the market for a speech amplifier or public address equipment of any kind you can buy nothing finer than CLARION. See the various models at our store or send for illustrated circular.

- TAYLOR T20 \$ 2.45
- TAYLOR T220 2.45
- TAYLOR T125 (See Taylor Ad this Issue) 13.50
- TAYLOR 203Z 8.50

- EIMAC 100TH \$13.50
- EIMAC 250TH 24.50

- AMPEREX HF100 \$12.50
- RAYTHEON RK39 3.50
- RAYTHEON RK34 3.50

W3AHR

MAIL ORDERS PROMPTLY FILLED

W3BMS

CONSOLIDATED RADIO CORP., 612 Arch St., Philadelphia, Pa.

HYVOL

HIGH-VOLTAGE CAPACITORS

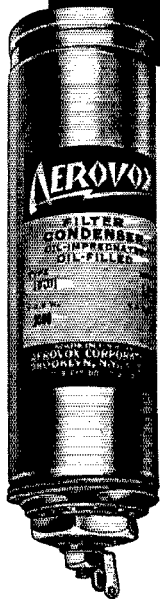

- ★ Handy. Inexpensive. Genuine oil-filled units for high-voltage filter circuits.
- ★ Compactness due to HYVOL — the super-dielectric oil.
- ★ Inverted screw mounting. 1½" dia. Either 2½" or 4½" tall.
- ★ .5 to 4 mfd. 600, 1000 and 1500 v. D.C. working. A lot of high-voltage capacity for little money.

New CATALOG . . .

15th Anniversary Edition. 32 pages. Many new items. Ask your supplier — or write us for copy.



SMALL SIZE WITH TOP PERFORMANCE

NEW V-1 VELOCITY MICROPHONE

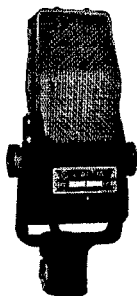

- The Smallest High-Fidelity Velocity Microphone
- Zero Cavity Resonance
- Integral Shock Absorber
- Cable and Connector
- Dependable — Suitable for Tropical Service
- Thoroughly Hum-Free
- The new V-1 has all the features of microphones in the higher priced brackets.

SEE YOUR JOBBER
Write for Catalog

LIST PRICE **\$25**

ELECTRO-VOICE
MANUFACTURING COMPANY
326 E. Colfax Ave., South Bend, Indiana
Export Office: 100 Varick St., New York, N. Y.

is used, a knob may be put on it. The original calibration of the crystal will of course be changed somewhat and if it is desired to know the exact frequency at various settings it will be necessary to recalibrate. The same frequency will always be found at the same setting of the adjustment.

The introduction of the air gap will cause a noticeable decrease in crystal current, making for safer operation of the crystal as well.

—L. W. Sorensen, W6JWQ

Dakota Division Convention

GOOD fellowship was the keynote of the A.R.R.L. Dakota Division Mid-American Convention held at the Lowry Hotel, St. Paul, Minn., on May 21st, 22nd and 23rd, under the auspices of the St. Paul Radio Club. The live-wire committee, consisting of members of both the St. Paul and Minneapolis clubs and headed by Neil B. Coil, W9BCT, spared no efforts to assure a good time for all.

Friday morning, the 21st, was devoted to registration and a general get-acquainted period. The equipment and prize display room was the object of longing eyes throughout the entire convention (especially the complete \$250 transmitter!). The afternoon session included sound movies by Bell Laboratories on "making water-cooled tubes" and "trans-Atlantic" radiophone; a talk by R. M. Planck, vice president and chief engineer of R.M.E.; a discussion of radio experiences during the Ohio Valley flood by Al Kahn, W9KYM; and a demonstration of cathode ray tubes by W9DKL and Ralph Bolland of Lew Bonn Co. The A.R.R.L. open meeting in the evening was conducted by the Division Director, Carl Jabs, W9BVH, and included talks by Sumner Young, W9HCC; Fred Young, W9MZN; and E. L. Battley, A.R.R.L. A.C.M. A "talkie" furnished by the National Carbon Co. disclosed the secrets in the manufacture of air cell batteries. The "Old Timers Get-Together" (so-called!) proved of interest to the young squirts as well as the old boys. Ask the fellows who were there!

Saturday morning was more or less "the morning after the night before," although a number of hardy souls awoke early enough to take advantage of the license exams held at the hotel. George Collier, W9CWI/WCCO, spoke on the "J" antenna and W9KYM, president of the Electro-Voice Mfg. Co., told all about ribbon microphones and preamplifiers. Following group meetings and luncheons of the Dakota Division Radiophone Assn., A.A.R.S. and N.C.R., the gang assembled to hear talks by L. W. Olander, chief engineer, E. F. Johnson Co., on antenna systems; Boyd Phelps, W9BP/W2BP, Lew Bonn Co., who demonstrated ultra-high frequencies and micro-waves; James McLaughlin, chief engineer of The Hallicrafters, Inc., on modern receiver design; and Dr. Henry Hartig, professor of Communication Engineering, University of Minn., who gave an intensely interesting demonstration of antennas and feeder systems, using a vibrating string and stroboscope lighting.

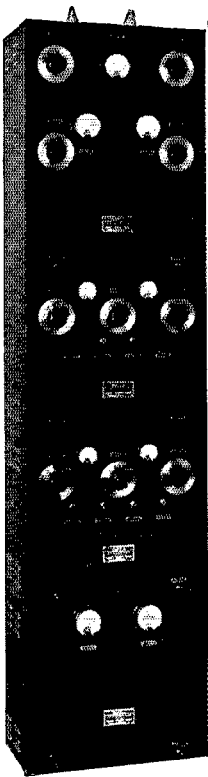

AMATEUR TRANSMITTER KITS

Give you

MORE WATTS PER DOLLAR

FOUNDATION KIT \$49.75 80 WATTS INPUT
LESS TUBES — METERS and CRYSTALS

KIT NO. 1

● Oscillator stage, with a 6L6 tube in a regenerative circuit affords high output, is rich in harmonics, and permits a much lower current in the grid circuit. Operates on fundamental or harmonic frequency. Ample excitation provided, even for 100% modulated phone transmission. Link coupling. Tuned grid circuit. 90 watts output has been attained. Cost is far less than similar jobs with but half this power. Entirely practical for beginners, and amateurs who already have a rig.

KIT NO. 2

● A high fidelity amplifier and modulation stage for inputs up to 100 watts R. F. Self-contained power supply and mixing facilities for crystal "mike," 200 ohm line, phonograph or radio. Am-

plifier for PA installations. A 75 watt phone transmitter when used with Kit No. 1.

KIT NO. 3

● A Universal Antenna Coupler which can be used to couple any combination of Kits to any size or style antenna.

KIT NO. 4

● A high power 400 watt R. F. stage. When used with Kit No. 1, it forms a 400 watt C. W. transmitter.

KIT NO. 5

● A high fidelity class B output stage, which completely modulates Kit No. 4 when used in conjunction with Kit No. 1.

See your Jobber or address Department Q9 for details

UTAH RADIO PRODUCTS COMPANY

Toronto
Ontario, Canada

Chicago, Illinois

Buenos Aires
(Ucoa Radio Products Co.)

"16 YEARS OF LEADERSHIP"

NEW PHONES FOR THE RIG

Amateurs! Check your requirements and don't forget the importance of your phones. Get new ones—get better ones—get FEATHERWEIGHTS.

For information, write Dept. R-4

TRIMM RADIO MFG. CO.
1770 Berteau Ave. Chicago, Illinois

LEARN RADIO

— TELEVISION —

New Beginners' Class Sept. 13th. Send for 48-page catalogue, explains fully; 500 licensed graduates placed in last six years in broadcasting, shipping, police radio, aviation, etc. Oldest, largest and best equipped school in N. E. We teach all branches of radio. Tel. HAN. 8184.

Ten operators placed with Pan-American Airways in one week.

Radio Service Instructions Given

Open All Summer

MASS. RADIO SCHOOL
18 Boylston Street, Boston

Improves Your 'Fist'

Cuts Effort in Half

Insist on The Genuine Martin

VIBROPLEX

SEMI-AUTOMATIC KEY

Simply press lever—machine does the rest

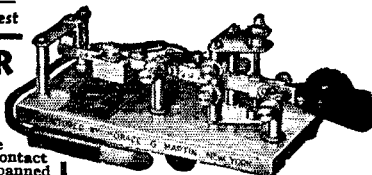

JUNIOR ONLY \$12.50

Small and more compact. Large contact points. Black japanned base. A low priced key with world famous Vibroplex Quality. Other models, \$17 and \$19.

Vibroplex's machine speed, superior signal and effortless operation assures the user the fastest, best and easiest way to send. Experienced operators know this—that's why over 100,000 of them use only the Vibroplex key.

Faster than the fastest hand sender—less than half the effort. Easy to learn. Easy to use. Easy to own. Order to-day! Insist on the Genuine Martin Vibroplex key. Accept no substitute. Liberal allowance on old Vibroplex. Money order or registered mail. Write for FREE illustrated catalog just off the press.

FREE CATALOG



THE VIBROPLEX CO. Inc.

832 Broadway

New York, N. Y.

Unconditionally Guaranteed

PR CRYSTALS

Powerful Reliable

X cut 7000 KG = 5 KG. . . \$1.85 3500 or 1750 . . . \$1.65
Low Drift = 5KG 40-80-160. 2.20

PETERSEN RADIO CO.

COUNCIL BLUFFS, IOWA

Formerly Omaha Crystal Labs.

Representing Eastern Radio Manufacturers

Don C. Wallace

(W6AM)

MANUFACTURERS' REPRESENTATIVE

PACIFIC COAST REPRESENTATIVE

Phone 434-59 4214 Country Club Drive, Long Beach, Calif.

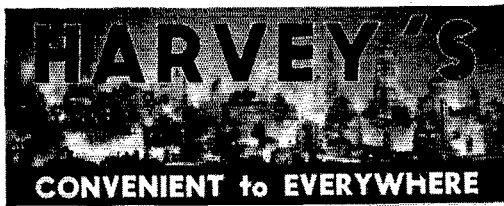

Whether the commodity to be bought is merchandise or a service . . . a transmitter or a travel tour . . . the wise and experienced buyer looks closely at the reputation of the company who sells it. HARVEY has earned the confidence and goodwill of amateurs everywhere . . . through an earnest endeavor to give them a BIGGER value for their "ham" dollar.

TAYLOR T-20, T-55 TRANSMITTER KITS

This very fine transmitter is the first medium power rig that will work as efficiently on 160 meters as on 10. This is made possible through a unique arrangement used by Earl Anderson, whereby the split stator condenser is used in a parallel arrangement on 160 meters and in series on the high frequency bands. All this is accomplished in the base arrangement of the plugs. Since insulation plays an important part in high frequency operation, only the best quality parts are used in this transmitter.

We furnish CARDWELL condensers, NATIONAL coil forms and sockets, UTC transformers, IRC insulated resistors, SANGAMO and CORNELL-DUBILIER condensers, a drilled and punched black crackle chassis (so that all the hard work is finished, and all that remains is a few hours of simple wiring.)

We also furnish a complete kit of coil forms and wire, exactly as shown on page 23 of the June, 1937, issue of QST. The power supply for the T-55 stage is made to deliver as high as 1300 volts at 300 ma. This allows for the addition of another T-55 at some future time. The power supply has a tapped arrangement for 850 volts, 1060 volts or 1300 volts. The smaller supply will deliver 500 volts at 200 ma.

Net price for transmitter kit	\$39.95
Net price for power supply kit	18.95
Net price for low voltage kit	9.95
Net price for Taylor T-20	2.45
Net price for Taylor T-55	8.00
Net price for Taylor 866 Jr.	1.00
Net price for RCA 6L6	1.35
Net price for RCA 8396

OUR *Best* VALUE IS OUR RECORD OF LOYAL SERVICE

HARVEY

Radio Company of New York

103 WEST 43rd STREET • NEW YORK, N. Y.

CABLE ADDRESS: "HARADIO"

Four hundred and twenty-seven enthusiastic hams, their YF's and YL's, were seated at the banquet tables Saturday evening. "Beep," W9BP, did an excellent job as toastmaster, keeping the crowd in a jovial mood. A bit of "horse play" regarding various types of haircuts in evidence among the gang was climaxed by the almost-bald Rex Munger's (W9LIP) retort that his hair was "biased beyond cut-off!" The entertainment, with Jim McLaughlin as master of ceremonies, was absolute tops; the entertainers (WCCO artists) were run ragged keeping up with the encores. The festivities came to a close with a gala prize drawing, amid the usual cheers and boos.

Sunday morning wound up the official sessions with a talk on quartz crystals by O. S. Keay, W9SJK; a general discussion covering rhombic antennas and Class B and C amplifier adjustments by Lester Carr, W9AOK/KSTP/KABE; and a transmitter tube discussion by Earl Anderson, W8UD, of Taylor Tube Co. An inspection of broadcast stations WTCN and KSTP was found interesting by many of the lads. Those who did not have to leave for home enjoyed an afternoon outing and picnic at Como Park where a softball game, tug-of-war (phone-c.w.) and various contests took place. The weather was perfect. Mobile and portable equipment was in operation, and a hidden transmitter hunt kept some of the boys well occupied. Felix LaVallee of Hugo, Minn., demonstrated a radio-controlled model boat which he had built; it does everything except fly—but Felix is now working on a radio-controlled plane to take care of that feature.

Congratulations are due the St. Paul and Minneapolis clubs on a swell job. It was an enjoyable affair all the way through, and nothing is left to be said except, "See you next year!"

—E. L. B.

Rocky Mountain Division Convention Colorado Springs, Colorado

ADDITIONAL information regarding the Rocky Mountain Division Convention to be held on September 4th and 5th at Colorado Springs, Colo.: Registration will be at Stratton Park Inn, at the entrance to the North and South Cheyenne Cañons, September 4th from 12:00 to 1:00 p.m. Registration fee \$2.50. Cars will be routed up North Cheyenne Cañon to Bruin Inn, a distance of about three miles of fine scenery. The afternoon session will be held at Bruin Inn. The Banquet will be served at Stratton Park Inn. At midnight an initiation of the Royal Order of the Wouff Hong will take place at the bottom of the Cave of the Winds. Further information may be obtained from Chas. E. Hathaway, 1512 North Corona St., Colorado Springs, Colo.

Built for PERFORMANCE

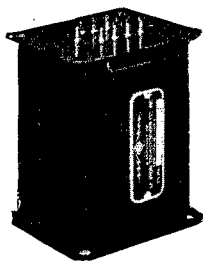

KEN-O-TAP

The Universal Modulation Transformer

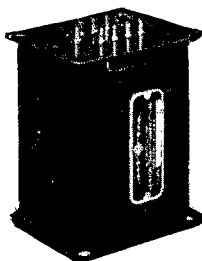

THE RELIABLE SOLUTION TO THE
MODULATION PROBLEM

These low cost modulation transformers may be used with any type of tube or tube combinations for transmitters. The multi-taps provide impedances to match any combination of modulator or class "C" conditions encountered in amateur transmitter applications. Will never become obsolete. Universal mounting facilities permit top or bottom mounting. All units are impregnated in varnish under a high vacuum, and sealed in a non-hygroscopic compound.

Type No.

Type No.	Audio Level	Amateur's Net Price
T-493.....	40 watts—will modulate 80 watts.....	\$ 4.20
T-494.....	75 watts—will modulate 150 watts.....	6.00
T-495.....	125 watts—will modulate 250 watts.....	12.00
T-496.....	300 watts—will modulate 600 watts.....	18.00

For full information on these units ask your dealer for the new "T" Line catalog describing our complete line of Amateur, P. A., and Power Components

Chief Engineer

Amateur Department

KENYON TRANSFORMER CO. INC.

840 Barry Street, New York, N. Y.

Export Department—M. Simons & Son, Inc., 25 Warren Street, New York, N. Y.

FLASH!

Place Your Order at Once for the New **NATIONAL NC-80X**
or **NC-81X** 10 Tube Receiver, Net Cash Price \$88.00
DOWN PAYMENT ONLY \$10.00

WE ARE ALSO MAKING IMMEDIATE DELIVERY ON

NATIONAL — HAMMARLUND — PATTERSON — BREITING
HALLICRAFTERS — RME 69 — RCA-ACR 111
HARVEY UHX-10, ETC.

We represent all leading manufacturers of receivers, transmitters, tubes, parts, etc., and our convenient time payment plan is available on all orders of \$25.00 net or over. Send us the list of material you need and we will send quotations and terms. No time payments outside U.S.A.

Our Special 20 Payment Plan Will Interest You

SEND 3¢ IN STAMPS FOR COMPLETE DETAILS

DELAWARE RADIO SALES COMPANY

WILLARD S. WILSON — W3DQ

405 Delaware Ave.

ESTAB. 1920

Wilmington, Delaware

LYNCH GIANT KILLER CABLE

For any and all types of radio frequency transmitting and receiving systems.

Not only endorsed by, but used by leading radio experts everywhere.

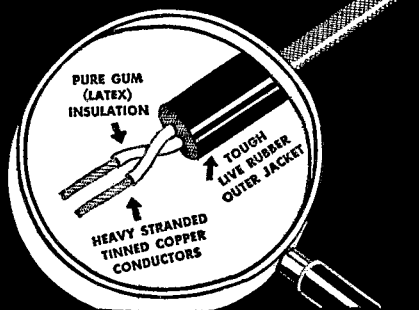

World's Largest Makers of Antenna Systems

L. S. BRACH Mfg. Corp.

Newark, N. J.



Est. 1906

WE OFFER —

SPECIALIZED PERSONAL SERVICE of genuine value that is not available from other jobbers.

TIME SALES of all receivers and transmitters with terms arranged to suit you and 6% finance charge. We finance our own paper. **TRADE IN** your equipment for the down payment.

HARVEY, RCA, RME, All Star, Progressive transmitters on terms. All amateur apparatus at net prices.

TRADE IN YOUR RECEIVER

All receivers shipped on ten day trial. You need send but \$5.00 with order, balance C.O.D. These receivers in stock:

RME-69s Complete.....	\$151.20
1937 Bretling 14s.....	108.00
The new Patterson PR-15.....	109.50
The new RCA ACR-111.....	189.50
RCA ACR-155.....	74.50
RCA ACR-175s.....	119.50
The new 1937 Super Pro.....	238.14
The new Hallicrafters 1938 S-16 Super Skyrider	99.00
Hallicrafters Sky Challenger S-15.....	69.50
Hallicrafters Sky Buddys.....	29.50
Hallicrafters Sky Chiefs.....	44.50
Hallicrafters Ultra Skyriders S-10.....	99.50

Every order and inquiry is personally attended to by Robert Henry, W9ARA, an active amateur for twelve years; graduate E.E. from M. I. T. and owner of Henry Radio Shop selling amateur supplies for eight years. You can reach me by letter, telegram, phone call, or visit 24 hours a day, 365 days a year. Write for any information.

HENRY RADIO SHOP

211-215 North Main Street

BUTLER, MISSOURI

Maritime Division Convention

Halifax, Nova Scotia

THE Halifax Hamfest, a Maritime Division Convention of the A.R.R.L. sponsored by the Halifax Amateur Radio Club, will be held September 4th, 5th and 6th at the Lord Nelson Hotel, Halifax, N. S. An unusually fine program has been arranged and the local boys assure a bang up time. Registration Fee \$2.50 for hams and SWL's; \$1.00 for YL's and YF's. Make your reservations through The Secretary, Halifax Amateur Radio Club, Room 50, Y.M.C.A., Halifax, N. S. Bring your 56-Mc. rig.

Connecticut State Convention

September 25th and 26th, at Bridgeport, Conn.

CONNECTICUT State Conventions are now annual affairs and the Bridgeport Amateur Radio Association is again sponsoring this year's affair to be held at the Hotel Stratfield, Bridgeport, Conn., September 25th and 26th. Several interesting events have been planned amongst which is the talk of Jules T. Steiger, WIBGY, the first district QSL manager, and he will also bring along cards for those DX fellows, enabling them to get the long awaited QSL cards they have been expecting. The Toastmaster for the banquet is none other than A.R.R.L. Vice-President Geo. W. Bailey. A big party and dance is planned for Saturday night with a half hour "amateur hour" broadcast over WICC. The Banquet will take place Sunday at 2:30 p.m. with prize drawing following, thus enabling the guests to leave and get home in the daylight if they come from any distance.

Registration and payment in advance, \$3.00 (banquet, etc., complete).

Registration for meetings and prize drawing only, in advance \$1.50.

Registration at the door, \$3.50 (including banquet) complete.

Registration at the door, meetings and prize drawing only, \$1.75.

Send your registration to or if you want further information address Gilbert F. Williams, Chairman, 170 Dixon St., Bridgeport, Conn.

New Receiving Tubes

6ZY5G

(Continued from page 98)

The 6ZY5G belongs to the low-power rectifier group, and is a full-wave, high-vacuum unit similar to the 84. The ratings are lower, however, because this is also a low heater current tube, taking 0.3 amp. Maximum a.c. voltage per plate, 350 r.m.s.; maximum peak current per plate, 150 ma. The potential difference between heater and cathode should not exceed 400 volts.

STATION OPERATING SUPPLIES

For full enjoyment of your operating activities
you will want these forms designed to meet
your needs



HANDY TO USE

The most interesting feature of the new LOG BOOK is the incorporation of spiral binding. This permits the book to be folded back flat at any page, requiring only half the amount of space on the operating table and making it easy to write on. The log-sheet has been redesigned by the Communications Department so that there is space provided for recording the number of messages handled and QSL's sent and received. General log information (prefixes, etc.) has been brought up-to-date. The LOG BOOK price has been reduced and is now 35c per book, 3 books for \$1.00, postpaid.

FOR PRESTIGE

The radiogram blank is now an entirely new form, designed by the Communications Department to comply with the new order of transmission. All blocks for fill-in are properly spaced for use in typewriter. It has a strikingly new heading that you will like. Radiogram blanks, $8\frac{1}{2} \times 7\frac{1}{4}$, lithographed in green ink, and padded 100 blanks to the pad, are now priced at 25c per pad, postpaid.

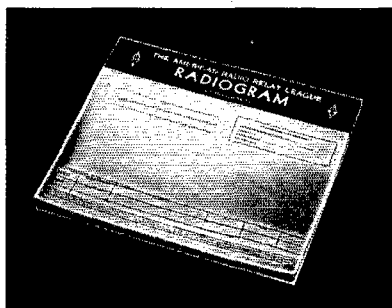

FOR CONVENIENCE

Radiogram delivery cards embody the same design as the radiogram blank and are avail-



able in two forms — on stamped government postcard, 2c each; unstamped, 1c each.

AMERICAN RADIO RELAY LEAGUE, INC.
WEST HARTFORD, CONNECTICUT

Where to buy it

A directory of suppliers who carry in stock the products of these dependable manufacturers.



ALBANY, N. Y. Uncle Dave's Radio Shack 356 Broadway

BALTIMORE, MD. Radio Electric Service Company 3 North Howard St.

BOSTON, MASS. Radio Shack 46 Brattle Street

NEWARK, N. J. Wholesale Radio Service Co., Inc. 219 Central Ave.

NEW YORK, N. Y. Gross Radio, Inc. 51 Vesey St.

NEW YORK, N. Y. Harrison Radio Co. 12 West Broadway

NEW YORK, N. Y. Wholesale Radio Service Co., Inc. 100 Sixth Ave.

NEW YORK, N. Y. Terminal Radio Corp. 80 Cortlandt Street

POTTSVILLE, PENN. Sylvester Radio & Supply Co., Inc. E. Norwegian & George Sts.

READING, PENN. George D. Barbey Company 404 Walnut St.

READING, PENN. Sylvester Radio & Supply Co., Inc. 104 North Ninth Street

SPRINGFIELD, MASS. T. F. Cushing 349 Worthington St.

WASHINGTON, D. C. Sun Radio & Service Supply Co. 938 F Street, N. W.



ALBANY, N. Y. Uncle Dave's Radio Shack 356 Broadway

BALTIMORE, MD. Radio Electric Service Company 3 North Howard St.

BOSTON, MASS. H. Jappe Company 46 Cornhill

BOSTON, MASS. Radio Shack 46 Brattle Street

BURLINGTON, VERMONT Vermont Hardware Co., Inc.

GREENWICH, CONN. Mead Stationery Company 252 Greenwich Ave.

MONTREAL, CANADA Canadian Electrical Supply Co., Ltd. 285 Craig Street, West

NEWARK, N. J. Wholesale Radio Service Co. 219 Central Avenue

NEW YORK, N. Y. Bruno-New York, Inc. 460 W. 34th St.

NEW YORK, N. Y. Sanford Samuel Corp. 136 Liberty St.

NEW YORK, N. Y. Wholesale Radio Service Co. 100 Sixth Avenue

NEW YORK, N. Y. Harrison Radio Company 12 West Broadway

NEW YORK, N. Y. Grand Central Radio, Inc. 124 E. 44th Street

PHILADELPHIA, PENN. Eugene G. Wile 10 S. 10th Street

PHILADELPHIA, PENN. Raymond Rosen & Company 117 North 7th St.

PHILADELPHIA, PENN. M & H Sporting Goods Company 512 Market Street

POTTSVILLE, PENN. Sylvester Radio & Supply Co., Inc. E. Norwegian & George Sts.

READING, PENN. Bright & Company 8th & Elm Streets

READING, PENN. Sylvester Radio & Supply Co., Inc. 104 North Ninth Street

SPRINGFIELD, MASS. T. F. Cushing 349 Worthington Street

SPRINGFIELD, MASS. S. S. Kresge Radio Department 1540 Main Street

Where to buy it

A directory of suppliers who carry in stock the products of these dependable manufacturers.

WASHINGTON, D. C. 938 F Street, N. W.
Sun Radio & Service Supply Co.

BUFFALO, NEW YORK 326 Elm Street
Radio Equipment Corp.

CONCORD, NEW HAMPSHIRE 80 N. State Street
Carl B. Evans

NEWARK, NEW JERSEY 219 Central Street
Wholesale Radio Service Co.

NEW YORK, N. Y. 12 West Broadway
Harrison Radio Company

NEW YORK, N. Y. 100 Sixth Avenue
Wholesale Radio Service Co.

WASHINGTON, D. C. 938 F Street, N. W.
Sun Radio & Service Supply Co.

RME
RECEIVERS -- PRE SELECTORS
AMATEUR RADIO EQUIPMENT
RADIO MFG. ENGINEERS, Inc.
PEORIA ILLINOIS

ALBANY, NEW YORK 356 Broadway
Uncle Dave's Radio Shack

BINGHAMTON, NEW YORK 25-27 Sturges Street
Radio Testing Station

BUFFALO, NEW YORK 216 E. Genessee Street
Dymac Radio

HARTFORD, CONNECTICUT 210 Chapel Street
Stern Wholesale Parts Company

NEW YORK, N. Y. 12 West Broadway
Harrison Radio Company

NEW YORK, N. Y. 80 Cortlandt Street
Terminal Radio Corp.

ROCHESTER, NEW YORK 244 Clinton Ave., N.
Radio Parts & Equipment Co.

WASHINGTON, D. C. 1837 Vernon St., N.W.
Upshur Radio Company

TRIPLET
INSTRUMENTS

ALBANY, N. Y. 356 Broadway
Uncle Dave's Radio Shack

BOSTON, MASS. 46 Brattle Street
Radio Shack

BOSTON, MASS. 28 Brattle St.
Selden Radio Company

MONTREAL, CANADA 285 Craig Street, West
Canadian Electrical Supply Co., Ltd.

NEWARK, N. J. 219 Central Ave.
Wholesale Radio Service Company

NEW YORK, N. Y. 100 Sixth Avenue
Wholesale Radio Service Company

POTTSVILLE, PENN. E. Norwegian & George Str.
Sylvester Radio & Supply Co., Inc.

READING, PENN. 404 Walnut Street
George D. Barbey Company

READING, PENN. 104 North Ninth St.
Sylvester Radio & Supply Co., Inc.

WASHINGTON, D. C. 938 F Street, N. W.
Sun Radio & Service Supply Co.

RAYTHEON
TRADE MARK
AMATEUR TUBES

ALBANY, NEW YORK 356 Broadway
Uncle Dave's Radio Shack

BOSTON, MASS. 46 Brattle Street
The Radio Shack

BOSTON, MASS. 28 Brattle Street
Selden Radio Company



BIRNBACH IMPROVED STANDOFF INSULATORS

Are the Favorites of the Experts

Because they are made of better ceramic. Come in a complete range of heights, for condenser, coils, tube sockets, etc. Can be mounted with a minimum of labor. White glaze.

No. 430.....	5/8" 10c list	No. 432.....	1 1/4" 20c list
No. 431.....	1" 15c list	No. 432J.....	1 1/4" 25c list
No. 431J.....	1" 20c list	No. 433.....	2 1/4" 25c list
	No. 433J.....	2 3/4" 50c list	

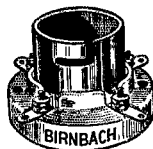

NEW LOW PRICES ON TRANSMITTING SOCKETS

It pays to buy the best so specify "Birnbach"

No. 434. 50 watt, list ea. \$1.25

No. 435. 10 watt, list ea. \$.85

Special Low Prices in Large Quantities Ask your jobber

BIRNBACH RADIO CO. INC.
145 HUDSON ST. BIRCO NEW YORK, N. Y.

"TELEVISION"

A NEW BOOK containing more than 20 illustrated papers by Dr. Zworykin and other leading RCA research engineers, giving latest laboratory and field reports on the new art, will be sent free of charge to paid-up subscribers of the

RCA REVIEW

A Quarterly Journal of Radio Progress

All phases of the radio art are discussed in *exclusive* articles in this outstanding radio journal. Every radio man should read it. The cost is only \$1.50 a year (Foreign \$1.85), including "Television." Order it now!

RCA INSTITUTES TECHNICAL PRESS

75 Varick Street

New York

122

Say You Saw It in QST — It Identifies You and Helps QST

New Tubes for Transmitting Applications 1608, 1609, 1610

THREE new small tubes, classified with the transmitting group and carrying the type numbers 1608, 1609 and 1610, have been announced by RCA. They are all "special purpose" types, and may fit into some amateur applications.

The 1608 is a coated-filament triode which will do about the same job as an 801, but at lower plate voltage and higher plate current. The maximum plate voltage rating is 425, maximum plate current 95 milliamperes. The tube has a 2.5-volt, 2.5-ampere filament. The amplification factor is 20. In different classes of service, typical operation at maximum plate voltage gives the following power outputs: Class-B audio, 50 watts (for a pair of tubes); Class-B r.f. linear, 10 watts; Class-C r.f., 27 watts.

The 1609 is a battery-type pentode of low microphonic design for speech amplifiers. The filament operates at 1.1 volt and 0.25 amp. Maximum plate voltage is 135, maximum screen voltage 67.5. The tube has a five-prong base with the standard pentode connections.

The 1610 apparently is a 47 with a new number and transmitting ratings. Characteristics and basing are exactly the same as those given for the 47. The tube is designated as a crystal-oscillator pentode. Maximum plate voltage is 400, maximum screen voltage is 200. Rated output is 5 watts as a Class-C amplifier with 400 volts on the plate and plate current of 22.5 milliamperes.

12-Volt RK Tubes Available for Mobile Work

THREE types of Raytheon transmitting tubes are now being made with 12.6-volt filaments for mobile and aircraft installations. Carrying the type numbers RK-44, RK-45 and RK-46, all three are pentodes; two practically duplicate existing Raytheon types except for filament ratings.

The RK-44 and RK-45 are low-power pentodes with indirectly-heated cathodes. Except for the filament rating of 12.6 volts and 0.45 amp., the RK-45 is identical in characteristics to the RK-25, the well-known small transmitting pentode. The RK-44 has somewhat higher ratings, the maximum plate voltage being 650 volts and the maximum plate current 80 milliamperes. The heater takes 0.7 amp. at 12.6 volts. It will give about 30 watts output as a Class-C amplifier.

The RK-46 is practically the same as the RK-20 except for the filament and the bulb. The filament takes 2.5 amps at 12.6 volts; in other respects the ratings are about the same. The hard-glass bulb and heavier filament give the tube the ability to stand up better under hard usage.

HAM-ADS

(1) Advertising shall pertain to radio and shall be of nature of interest to radio amateurs or experimenters in their pursuit of the art.

(2) No display of any character will be accepted, nor can any special typographical arrangement, such as all or part capital letters be used which would tend to make one advertisement stand out from the others.

(3) The Ham-Ad rate is 15c per word, except as noted in paragraph (6) below.

(4) Remittance in full must accompany copy. No cash or contract discount or agency commission will be allowed.

(5) Closing date for Ham-Ads is the 25th of the second month preceding publication date.

(6) A special rate of 7c per word will apply to advertising which, in our judgment, is obviously non-commercial in nature and is placed and signed by a member of the American Radio Relay League. Thus, advertising of bona fide surplus equipment owned, used and for sale by an individual or apparatus offered for exchange or advertising inquiring for special equipment, if by a member of the American Radio Relay League takes the 7c rate. An attempt to deal in apparatus in quantity for profit, even if by an individual, is commercial and takes the 15c rate. Provisions of paragraphs (1), (2), (4) and (5) apply to all advertising in this column regardless of which rate may apply.

Having made no investigation of the advertisers in the classified columns, the publishers of *QST* are unable to vouch for their integrity or for the grade or character of the products advertised.

QUARTZ—direct importers from Brazil of best quality pure quartz suitable for making piezo-electric crystals. Diamond Drill Carbon Co., 719 World Bldg., New York City.

RADIO engineering, broadcasting, aviation and police radio, servicing, marine and Morse telegraphy taught thoroughly. All expenses low. Catalog free. Dodge's Institute, Byrd St., Valparaiso, Ind.

NATIONAL—Hammarlund, RCA-RME used sets, 60% off list. W3DQ, 405 Delaware Ave., Wilmington, Del.

QSL'S, W2SN, Helmetta, N. J.

CALLBOOKS—new DX calls, new prefixes, thousands of new W and VE calls, in the Fall, 1937 Radio Amateur Call Book. Sent postpaid \$1.25, or a whole year (four issues) for \$4. (In foreign countries \$1.35 and \$4.35.) Your call and QRA printed in large type \$1 per year. Radio Amateur Call Book, 610 S Dearborn, Chicago.

QSL'S, all colors, cartoons, snappy service. Write for free samples today. WIBEF, 16 Stockbridge Ave., Lowell, Mass.

COMPLETE training for all amateur and professional radio licenses. New York Wireless School, 1123 Broadway, N. Y.

QSL'S. Better designs; better stock; better workmanship. Free samples to hams only. W2FJE, 143 DeKalb Ave., Brooklyn, N. Y.

CRYSTALS: Within ten kilocycles. X cut: 80M, \$1.50. V cuts: 80M, \$2.25. 160M, \$2.50. 40M, \$3. Unconditionally guaranteed. Low-priced mounted units. Holders. Request catalog. Ham Crystals, 1104 Lincoln Place, Brooklyn, New York.

QSL'S, SWL's. Unbeatable designs. Free samples. W8DED, Holland, Mich.

BLILEY crystals. (LD2 \$4.80; BC3 \$3.95) Order direct from W8DED.

CALLBOOKS. Fall issue \$1.25 from W8DED.

NC100X, complete, original A-1 condition, \$100. Nearly new RCA ATR219 transceiver, batteries, tubes \$17. W9UUJ, 823 Thirteenth St., Rockford, Ill.

SELL: Hallcrafters Skybuddy, best offer. W2BZB.

HICKOK instruments. Ham surplus. Cannady, 38 W. Anderson, Aurora, Mo.

QSL'S—Entirely new printing process makes more beautiful cards at lower cost—Send 10¢ in stamps for elaborate kit with which you can design your own card—Astonishingly inexpensive. QSL Company, Box 481, Hartford, Conn.

SELL: Browning 35 all-wave receiver complete tubes, speaker, \$20. Also Peak Q-5 (5-10) receiver with tubes—\$15, both pre-paid. W8NNE, 418 Fraser, Bay City, Mich.

SW3, tubes, 40-80 meter coils, power supply \$22. W6HGW.

QSL'S. Samples. Stamp. Printer, Corwith, Iowa.

WANTED: Collins 30FXB and National 1-10 receiver. Ad-dress W8PNF, Conneaut, Ohio.

QSL'S. Cartoons. Free samples. Theodore Porcher, 7708 Nava-hoe St., Philadelphia, Pa.

SELL: Complete station ready to operate. Transmitter in W.E. rack-cracked alum.—Output 300 w. ow—100 w. phone. Speech amplifier and receiver in table rack. Shure xtal mike—xtals—tubes—\$200. Ex-1CMP.

TRANSMITTING tubes repaired exchanged bought or sold. All types. W2AWZ, Dobbs Ferry, N. Y.

BROWNING '35, sell or trade for transmitting equipment. W9ZDH, 3502 S. Boots, Marion, Ind.

QSL cards, neat, attractive, reasonably priced. Samples free. Miller, Printer, Ambler, Pa.

FOR sale or trade: a.c.—xtl—phone transmitter for binoculars, outdoor motor or what? F. W. Steffen, Hartley, Iowa.

HAVE you seen Fritz's newest QSL's—SWL's? They're different. 203 Mason, Joliet, Ill.

THERE was no summer slump for Faberadio. Crystals 75¢. Dealers wanted. Faberadio, Sandwich, Ill.

FROM the estate of its late vice-president, Charles H. Stewart, W3ZS, and on behalf thereof, of the office of the American Radio Relay League, as agent, offers for quick cash sale the following items from that station f.o.b. Philadelphia: Homemade transmitter, in questionable operating condition, aluminum panel, crystal 1883 kc., 247 oscillator, 210 buffer-doubler, pair 210's final; set also contains 6 Weston 3" flush bakelite milliammeters for 1, 1½, 2, 50, 100 and 200 ma. and one ditto t/c r.f. 0-1.5 a., practically unused, all perfect; 4 National condensers; 2 National "B" verniers; ¼" tubing coils for 80 m.; price as is, meters guaranteed, \$40. M & H plate transformer in cast aluminum case; primary 110 v. 60 c., secondary 300 ma. tapped 500, 1000 and 2000 each side center-tap, \$6. M & H choke, cast aluminum case, 30 henries, 150 ma., \$1.50. National SW5 receiver with 2½-v. tubes and coils for broadcast range, no power supply, like new, \$12. Gross combination monitor-portable receiver, two 30 tubes, complete with all three coils, \$4. 1 unused UV-203-A and RCA socket therefor, \$8. Jewell 4" flush metal a.c. voltmeter 0-10, \$2. Jewell 3" flush bakelite dual-range a.c. voltmeter 0-3 and 0-15, \$2.50. Jewell 3" flush metal a.c. voltmeter 0-15, \$2. RCA EBT3620 Kenotron rectifier power supply with two 281 tubes, fair condition, \$4. 2 unused Flechtheim filter condensers, 2ufd. 1500 v. d.c., \$1.50 for both. Tube filter condenser, 2ufd. 1000 v. d.c., \$0.50. 2 Pyrex lead-thrus, 2½" bowls and gaskets, rods ¾" x 20, \$1 for both. 4 Pyrex bowls about 6" diam., holes about ¾", \$1.50 for all. 2 unused National Velvet verniers type B \$1 for both. 2 P.R.R. sounders, 51 ohms, excellent condition, \$2 for both. Address all orders to American Radio Relay League, West Hartford, Conn.

FOR sale: WIHXX-rack and panel transmitter using 203A final amplifier. Rugged construction and fine appearance. Reasonably priced. On display at Kraus & Co., 89 Broadway, Providence, R. I.

SELL or trade large oil-filled Westinghouse condensers, \$12., weight 50 lbs., handles 3000v O.K. W5KD, 215 W. 19, Oklahoma City.

QSL'S SWL's, 100 colored, 75¢. Lappco, 344 W. 39, Indianapolis, Ind.

FOR sale: FB7A with tubes, preselector, power supply, 20-40-160 meter coils; excellent condition, \$40. W8KPO, 543 Franklin, Buffalo, N. Y.

QSL'S. New designs, low prices. Samples. Maleco, 1512 Eastern Parkway, Brooklyn, N. Y.

P. A. amplifier, operates from storage battery, 30 watts output, with built-in turntable and pickup, \$30. Universal Model 30-E condenser microphone, fine studio type, with preamplifier, \$15. S. J. White, 47 W. 86th St., N. Y.

ACSW3, coils, tubes, first class, \$17. Write Dick Werthimer, Glencoe, Ill.

WANTED: National SW3—d.c. Carl A. Howe, Tyler, Minn.

FILTERS: have several new Cornell-Dubilier paper, oil & dykanol transmitting condensers—2 mfd. 1000 v. \$1.80; 4 mfd. \$3. Also some 1 & 2 mfd. at higher voltages. W2AZI.

TWO Esco motorgenerator sets, 110-220 AC/2000 volts 300 watts DC and 110-220 AC/1000 volts 500 watts DC. Sell cheap. W8BLZ.

SEND 25¢ with your call, name and address for 75 two-color QSL's or ham letterheads. Kohler Press, 358 Ashburton, Yonkers, N. Y.

NEW RK20 and Harvey CT60 \$25. 300 watt 1500 volt supply \$20. FBXA \$30. WIDEC.

TELEPLEXES, instructographs, omographs, vibroplexes, bought, sold. Ryan's, Monroe City, Mo.

SELL ACR136, \$35. Sargeant Model 11 purchased new 1937 covering 80 to 34,000 kilocycles inclusive, \$45. Will ship for free trial, satisfaction or no sale. W. L. Smith, Box 436, Warrenton, Va.

FOR sale—HD203A, W8QHZ.

BEST offer takes pair brand new RCA carbon plate 211's. W2EEL.

METER repair service. Complete repair and replacement service on all types of meters. Reasonable prices. Braden Engineering Co., 303 Park Dr., Dayton, Ohio.

SELL or trade for U. S. rare coins xtal Super Skyrider and speaker, Kodak Reomar No. 18, 12 power Hoff French military binoculars, bound QST's 1921 to date. All issues Modern Radio, Triplet VT voltmeter, modulation meter and signal generator, Universal BB mike, Barr transceiver complete, Jewell 0-20,000 ohmmeter, 2 WE-211 E, 2 RCA, 203-A, 913 tubes, 500 and 300 mil modulation chokes, Jewell 2 mil meter, 7 1/4 and 150 DC voltmeter, 2 1/2 and 7 1/4 DC voltmeter, Everything new condition. M. L. Potter, 233 East Ave., Parkridge, Ill.

INQUIRE about commercial-like metal tube Super Gainer receiver—best parts—\$19. W3CVV.

QUALITY transformers and chokes. Guaranteed. Built to your requirements. Cheaply priced. W8EQ, 902 S. Elizabeth, Lima, Ohio.

CRYSTALS: Eidson T9 fracture resisting 40 and 80 meters, \$1.60 postpaid. Dependable—powerful X cut. Close frequency always supplied. Fully guaranteed, accurately calibrated. T9 superlapped ceramic plug-in holders, \$1.10 postpaid. C.O.D.'s accepted. Sold only by: Eidson's, Temple, Texas and Hieronymus Radio, 88-34 209th St., Queens Village, N. Y.

QSL's buy yours from a ham—\$1.80 for 300 2 colors postpaid. W9DGH.

WANTED: W.E. 618-A mic. Will buy or trade for Graflex or commercial tape transmitter and perforator. Edward P. York, 25 Irving Terrace, Cambridge, Mass.

FREQUENCY measurement for amateurs \$1.25. Write for details. Air Radio, Municipal Airport, Chicago, Ill.

RECEIVER headquarters, W8ANT.

NC100X with high fidelity speaker. In new condition—used two weeks. Substantial saving. W8ANT.

TRANSMITTER kits—W8ANT.

ALL lines of new and used equipment. Paris bought, sold, and exchanged. Write to Southern Ohio's only amateur owned amateur business. Jos. N. Davies, W8ANT, 2767 N. Bend Rd., Sta. A, Cincinnati, Ohio.

SELL: FBXA coils for all bands, bandspread \$4. a pair, general coverage \$3 a pair. FB7's with tubes \$22, FBX's \$28, Super Skyriders \$29, ACR-136's \$39, Silver 5C's \$39, Breting 12's \$64, RME9D's \$64, RME-69's \$99, other sets. Bob Henry, W9ARA, Butler, Mo.

QSL's—highest quality—lowest prices. Radio Headquarters, Ft. Wayne, Ind.

USED: guaranteed: WE261A \$4.50, WE211E \$2.50, 2-Rel type L inductors, perfect condition, \$1.50 each. W9GDB, Milford, Neb.

SELL: Commercial or ham, Harvey 200-R phone or c.w. transmitter complete with tubes, crystal microphone, key, four crystals, built-in antenna coupling unit with RF meter, remote control unit. Metal floor stand for transmitter. Bandswitching 20, 40, 80 also coils for 160. MI-4 modulation indicator. National NC100X complete. All practically new. Net cost \$550—will sell for \$355 or best offer. W1AKV.

NEAT permanent binders for Call Books, 40¢ postpaid, W6JTF.

UNIVERSAL Class B transformers—for use with all tubes. 50 watts audio \$4.95—pair—100 watts audio \$7.75 pair postpaid. Write for details, W8UD, Douglas, Mich.

RADIO

ENGINEERING, broadcasting, aviation and crystals, police radio, servicing, marine radio telegraphy and telephony, Morse telegraphy and railway accounting taught thoroughly. Engineering course of nine months duration equivalent to three years of college radio work. School established 1874. All expenses low. Catalog free.

DODGE'S INSTITUTE, Day Street, Valparaiso, Indiana

RADIO COURSES

RADIO OPERATING: Prepare for Gov't License Exam. ●
RADIO SERVICING: Including Short Wave ● AMATEUR
CODE ● ELECTRONICS ● TELEVISION ●

Day and Evening classes—Booklet upon request

NEW YORK YMCA SCHOOLS

4 West 63rd Street, New York City

YOU ARE INVITED TO INVESTIGATE
THE MANY ADVANTAGES OFFERED BY

EASTERN RADIO INSTITUTE

899 BOYLSTON STREET BOSTON, MASS.

HERE'S AN OPPORTUNITY for SEVERAL YOUNG MEN

Manufacturer offers all-around training to limited number of young men in laboratory, shop and installation of aircraft radio and electrical equipment, preparing for important positions with this and other organizations.

General requirements—A fundamental knowledge of radio and an intense interest in radio theory. High school education or better. Age 18 to 22, unmarried. Should be interested in working on or around airplanes, with an eager desire to learn, an earnest willingness to cooperate and work hard for advancement. Should have ability, experience in wiring, using hand and small machine tools. Capable of thoroughness in work. Must be good at mechanical drawing and drafting. Arrangements can be made to learn to fly.

No tuition charge. After the first two weeks a nominal salary will be paid which should cover living expenses while training. Promising future for those who qualify, as the art is new, the field uncrowded.

Write, stating all your qualifications. Give at least three references. Include your school and former employer. Upon receipt of application, we will send you full information for your consideration.

Address Box A Advertising Dep't.
West Hartford, Conn.

Quicker than *Littelfuse*

Increase the efficiency of your equipment by using INSTRUMENT LITTELFUSES. All types of fuses and mountings from world-famous factory. HI-VOLT LITTELFUSES for transmitters, etc., 1,000, 5,000 and 10,000 volt ranges, 1/16 amp. up. INSTRUMENT LITTELFUSES for meters, 1/200 amp. up. RADIO FUSES, AUTO FUSES, etc. You should know about Littelfuses. See your dealer or write for catalog.

LITTELFUSE LABS. 4246 Lincoln Ave. Chicago, Ill.

GULF RADIO SCHOOL

Radiotelegraphy Radiotelephony

Radio Servicing

SECOND PORT } 1007 Carondelet Street
U. S. A. } NEW ORLEANS, LA.

PRECISION CRYSTALS



Crystal Holder

Highest quality crystals, one inch square, carefully ground for frequency stability and maximum output. Be sure of your transmitter frequency—use PRECISION CRYSTALS.

Low frequency drift crystals (Type L T C) supplied within 0.1% of your specified frequency and calibrated to within 0.03% are priced as follows: 1750 and 3500 kc. bands — \$3.50 each. 7000 kc. band \$4.00 each. Holder \$1.00.

(Holder as illustrated to fit G.R. jacks or round holder to plug into a tube socket can be furnished. G.R. jacks to plug illustrated holder into — \$1.50 pair.)

'X' cut PRECISION Crystals carefully ground for maximum power supplied within 0.1% of your specified frequency and calibrated to within 0.03% are priced as follows: 1750, 3500 and 7000 kc. bands — \$3.00 each. Add \$1.00 if holder is desired.

'AT' cut crystals for commercial use quoted on at your request. When ordering our product you are assured of the finest obtainable. Now in our seventh year of business.

PRECISION PIEZO SERVICE

427 Asia Street Baton Rouge, La.

Your Nearest Dealer Is Your Best Friend

Your nearest dealer is entitled to your patronage. You can trust him. He is equipped with a knowledge and understanding of amateur radio. He is your logical and safe source of advice and counsel on what equipment you should buy. His stock is complete. He can supply your needs without delay. His prices are fair and consistent with the high quality of the goods he carries. He is responsible to you and interested in you.

Patronize the dealer nearest you—You can have confidence in him

ATLANTA, GEORGIA

Wholesale Radio Service Company, Inc.
430 West Peachtree Street, N. W.
"Investigate Our Easy Payment Plan"

BALTIMORE, MARYLAND

Radio Electric Service Co.
3 N. Howard St.
Everything for the amateur

BRONX, NEW YORK

Wholesale Radio Service Company, Inc.
542 East Fordham Road
"Investigate Our Easy Payment Plan"

BUFFALO, NEW YORK

Radio Equipment Corp.
326 Elm Street
W80BK — Ham, service and sound equipment — W80LB

BUFFALO, NEW YORK

Dymac Radio
216 E. Genesee Street
Complete Line Ham and BCL Equipment Cl. 2080

JAMAICA, L. I.

Wholesale Radio Service Company, Inc.
90-08 166th Street (Merrick Road)
"Investigate Our Easy Payment Plan"

MONTREAL, CANADA

Canadian Elec. Supply Co., Ltd.
285 Craig St., W.
Quality parts and equipment for discriminating buyers

NEWARK, N. J.

Wholesale Radio Service Company, Inc.
219 Central Avenue
"Investigate Our Easy Payment Plan"

NEW YORK, N. Y.

Gross Radio, Inc.
51 Vesey Street
Fair dealings plus fair prices. Anything in radio

NEW YORK, N. Y.

Wholesale Radio Service Company, Inc.
100 Sixth Avenue
"Investigate Our Easy Payment Plan"

NEW YORK, N. Y.

Harrison Radio Company
12 West Broadway.
"The Friendly Ham Supply House"

PHILADELPHIA, PENNSYLVANIA

Eugene G. Wile
10 S. Tenth Street
Complete Stock of Quality Merchandise

PROVIDENCE, RHODE ISLAND

W. H. Edwards Co.
32 Broadway
National, Taylor Tubes, Hallicrafters. Complete amateur supply house

PROVIDENCE, RHODE ISLAND

Kraus & Company
89 Broadway
Everything for the amateur and serviceman

RICHMOND, VIRGINIA

The Arnold Company
527 W. Broad Street
W3EHL—"The Virginia Ham Headquarters"—W3FBL

ROCHESTER, NEW YORK

Radio Parts & Equipment Co.
244 Clinton Avenue, North
Complete stock amateur-BCL parts. Standard discounts

SYRACUSE, NEW YORK

Roy C. Stage, W8IGF
Complete stock of standard Ham & BCL parts
Standard Discounts. Free technical service

SPRINGFIELD, MASS.

S. S. Kresge Company
1540 Main Street
Standard discounts, standard lines. Advisory service: W1JQ, W1FOF

You Are Protected When You Buy From QST Advertisers

“Advertising for QST is accepted only from firms who, in the publisher’s opinion, are of established integrity and whose products secure the approval of the technical staff of the American Radio Relay League.”

Quoted from QST’s advertising rate card.

Every conceivable need of a radio amateur can be supplied by the advertisers in QST. And you will know the product has the approval of the League’s technical staff.

For Your Convenience QST'S INDEX TO ADVERTISERS IN THIS ISSUE

Aerovox Corporation	114
Atkins & Brown	108
Bellefonte Radio Eng. & Mfg. Co., Inc.	99
Birnback Radio Company	122
Billey Electric Company	107
Brach Mfg. Company, L. S.	118
Brazilian Trading Company, Inc.	107
Burgess Battery Company	89
Burton-Rogers Company	113
Call Letter Plate Company	107
Candler System Company	99
Capitol Radio Engineering Institute	103
Cardwell Mfg. Corp., Allen D.	74
Centralab	85
Code-Craft	111
Cohen's Sons, Ltd., I. S.	117
Collins Radio Company	Cov. 2
Condenser Products	110
Consolidated Radio Corporation	113
Cornell-Dubilier Corporation	106
Delaware Radio Sales Company	117
Delco-Remy Corporation	93
Dodge's Institute	124
Eastern Radio Institute	124
Eitel and McCullough, Inc.	91
Electro-Voice Mfg. Company	114
Gardiner-Levering Company	111
General Electric Company	103
General Transformer Corporation	98
Gross Radio, Inc.	88
Gulf Radio School	124
Hallcrafters, Inc., The	1, 2
Hammarlund Mfg. Company, Inc.	4
Harvey Radio Company	116
Harvey Radio Laboratories, Inc.	111
Heintz & Kaufman, Ltd.	95
Henry Radio Shop	118
Hipower Crystal Company	103
Instructograph Company	107
International Resistance Company	75
Johnson Company, E. F.	71
Kato Engineering Company	99
Kenyon Transformer Co., Inc.	117
Leeds	86
Littelfuse Laboratories	124
Logan Company, Les	106
Mallory & Co., Inc., P. R.	70, 78
Massachusetts Radio School	115
McClroy, T. C.	107
McGraw-Hill Book Company	84
Meissner Mfg. Company	108
Mims Radio Company	90
National Company, Inc.	Cov. 3, Insert, 69, 77, 87
Newark Electric Company	72, 73
New York Y. M. C. A. Schools	124
Ohmite Mfg. Company	94
Petersen Radio Company	115
Port Arthur College	99
Precision Apparatus Corporation	102
Precision-Piezo Service	124
RCA Institutes, Inc.	111
RCA Institutes Technical Press	122
RCA Manufacturing Company	Cov. 4
Radio Mfg. Engineers, Inc.	127
Radio Supply Company	113
Radio Transceiver Laboratories	96
Raytheon Production Corp.	76
Readrite Meter Works	90
Scientific Radio Service	111
Shure Brothers	110
Speer Carbon Company	81
Standard Transformer Corp.	92
Sun Radio Company	112
Taylor Tubes, Inc.	79
Telexplex Company	111
Terminal Radio Corporation	109
Thordarson Elec. Mfg. Company	83
Trimn Radio Mfg. Company	115
Triplett Electrical Instrument Co.	80
Turner Company	94
United Transformer Company	128
Utah Radio Products Corp.	115
Valpey Crystals, The	92
Van Sickle Radio, Inc.	113
Vibroplex Company	115
Wallace, Don C.	115
Ward Leonard Electric Company	98
Western Electric Company	82
Wilson, Willard S.	117
Wincharger Corporation	102
Wright-DeCoster, Inc.	96
Yaxley	70, 78

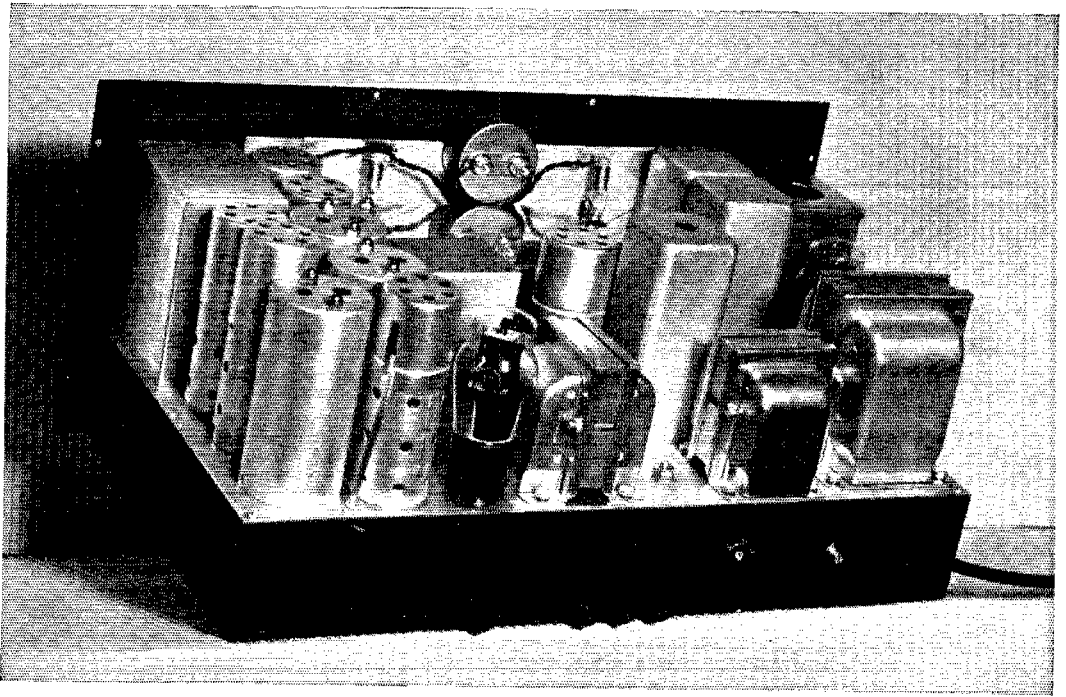

A Timely Suggestion

Now... at the threshold of the Fall season of intensive radio activity... is the time to replace your out-moded receiver with newer and better equipment, built to 1938 standards.

RME-69 incorporates the very latest devices that are of practical advantage to the radio operator, whether he is located close to the large centers of population or at an airport station serving remote locations.

NOTE THESE IMPORTANT FEATURES:

Planetary Vernier Dial Drive, for smoother and easier tuning.

Full Electrical Band-Spread

Individual Dial Operation

Six-Band Tuning Range

Calibrated Decibel R-Meter

Built-in Monitor Circuit

... and many others

Write for Literature

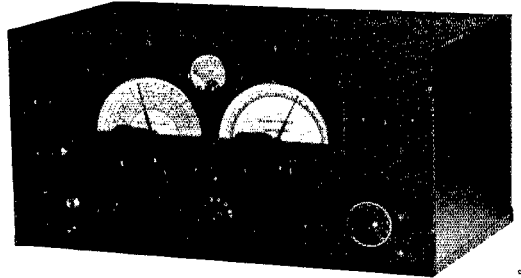

Standard Equipment in

Naval Bases on Western Coast

Army Bases in Alaska

Government Forestry Service

Greenland Expedition of 1937

RADIO MFG. ENGINEERS PEORIA ILLINOIS

RME - 69

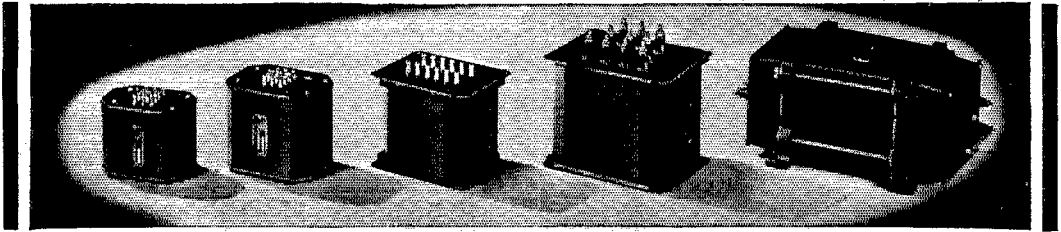

UTC VARIMATCH transformers are recognized universally as being BETTER input and output transformers for matching any modulator tubes to any RF load . . . See for yourself . . .

Power to spare . . . at NEW LOW PRICES

Built-in integrity that Hamdom associates with every UTC product . . . at prices that every Ham can afford. Your transmitter deserves the best. UTC power supply units are superior and do not cost any more.

PLATE TRANSFORMERS

- | | |
|---|---|
| <p>UH-7 475 each side of center at 250 MA, 5V-3A, 2½V-3A, 6.3V-4A, 6.3V-4A. \$6.30</p> <p>CS-200 450 each side of center at 150 MA, 5V-3A, 2½V-10A. CV mtg. . . \$3.90</p> <p>CS-201 500 each side of center at 200 MA, 2½V, C.T. 14A, 5V. C.T. 3A, CD mtg. \$4.80</p> <p>CS-202 600 each side of center at 200 MA, 2½V-10A, 7½V-3A, 5V-3A. CD mtg. \$6.00</p> <p>CS-203 800 each side of center at 150 MA, 660V. P.S. CD mtg. \$4.50</p> <p>CS-204 800 each side of center at 250 MA, 650V. DC. CD mtg. \$6.60</p> <p>PA-111 750 or 950 each side of center at 350 MA; DC. voltage 600 or 750. PA-4. Net to Hams. . . \$10.80</p> <p>PA-112 1250 or 1500 each side of center at 500 MA; DC. voltage 1050 or 1250. PA-6. Net to Hams. . . \$21.00</p> | <p>PA-113 1750 or 2100 each side of center at 500 MA; DC. voltage 1500 or 1750. PA-6. Net to Hams. . . \$28.50</p> <p>PA-114 1750, 2350, 3000 or 3500 each side of center at 500 MA; DC. voltage 1500, 2000, 2500 or 3000, UTS mtg. Net to hams. . . \$45.60</p> <p>PA-118 1750 or 2400 each side of center at 325 MA; DC. voltage 1500 or 2000. PA-6 mtg. Net to Hams \$23.40</p> <p>CS-212 475 each side of center at 500 MA; 5V. C.T. 6A, for 4-6L6's fixed bias, etc. DC. voltage 400 CD mtg. \$8.40</p> <p>PA-116 1250 or 1500 each side of center at 300 MA; DC. voltage 1050 or 1250. PA-5. Net to Hams. . . \$15.00</p> <p>PA-119 1500 or 1750 each side of center at 1 amp. DC. voltage 1250 or 1500. UTS case. Net to Hams. . . \$45.60</p> |
|---|---|

All PA type plate transformers have tapped primaries of 105, 115, 220, 230 volts, A.C. 50/60 cycles.

The Varimatch Transformer will not only match PRESENT available modulator tubes, but any tube that may be released at a FUTURE date. All you have to decide is the DC input to your RF stage. Then just pick the VARIMATCH output transformer that will handle the maximum audio power required. The secondaries of all Varimatch transformers are designed to carry the Class C plate current.

- ★ **VM-0** Will handle any power tubes to modulate a 10 to 25 watt Class C stage. PA-1. Net to Hams. **\$3.00**
- ★ **VM-1** Will handle any power tubes to modulate a 20 to 60 watt Class C stage. Maximum audio output 30 watts. Net to Hams. **\$4.80**
- ★ **VM-2** Will handle any power tubes to modulate a 40 to 120 watt Class C stage. Maximum audio output 60 watts. Net to Hams. **\$7.50**
- ★ **VM-3** Will handle any power tubes to modulate a 100 to 250 watt Class C stage. Maximum audio output 125 watts. Net to Hams. **\$12.00**
- ★ **VM-4** Will handle any power tubes to modulate a 200 to 600 watt Class C stage. Maximum audio output 300 watts. Net to Hams. **\$19.50**
- ★ **VM-5** Will handle any power tubes to modulate a 450 watt to 1 KW plus, Class C stage. Maximum audio output 600 watts. Net to Hams. **\$42.00**
- ★ **PA-52AX** Push pull 45, 59, 2A3 or 6L6 plates to 2-46 Class B grids. Push pull 45, 59, 2A3 or 6L6 plates to 4-46 or 59 Class B grids. Push pull 2A3's to 2-841, 35T, 50T, 756, 825 Class B grids. Net to Hams. **\$3.90**
- ★ **PA-53AX** Push pull 42, 45, 50, 59, 2A3 or 6L6 plates to two 210, 801, RK-18, 35T, 50T, HF-100 or 800 Class B grids. Push pull 2A3 plates to two 838, 203A, 50T, 35T, 211A, 242A, 830B, 800, RK-18, 801 or 210 Class B grids. Net to Hams. **\$4.50**
- ★ **PA-238AX** Push pull parallel 2A3, 45, 50, 59 or 6L6 to four 805, 838, or 203A Class B grids. Push pull parallel 2A3, 45, 50, 59, 6L6 or two 211A, 845 plates to Class B 204A. HF300 or 849 grids. Push pull parallel 2A3, 45, 50 or two 50T, 211A, 845 plates to Class B 150T, HD 203A or HF 200 Class B grids. Net to Hams. **\$10.50**

THE VARIMATCH TRANSFORMER NEVER BECOMES OBSOLETE

UNITED TRANSFORMER CORP.
 72 SPRING STREET • NEW YORK, N. Y.
 EXPORT DIVISION 100 VARICK STREET NEW YORK, N. Y. CABLES "ARLAB"

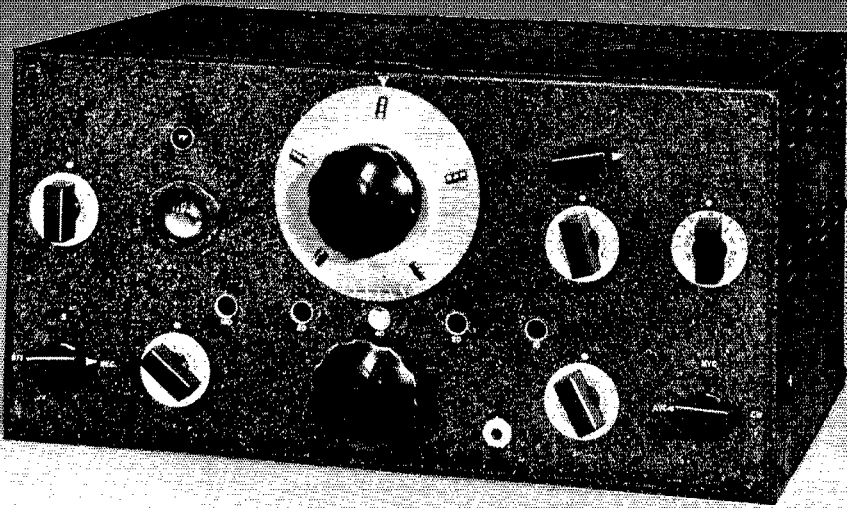

Perhaps you prefer the strictly amateur NC-101X which picks off any of five amateur bands at will with a turn of the wrist. Perhaps you value the extra entertainment possibilities of the NC-100X's continuous coverage. Either way, you know your receiver has proven performance, high quality, and sturdy reliability. Both models are based on the same advanced design principles. Both offer a maximum of value at a minimum of cost.

NATIONAL NC-101X

NATIONAL COMPANY, INC.
MALDEN, MASS.

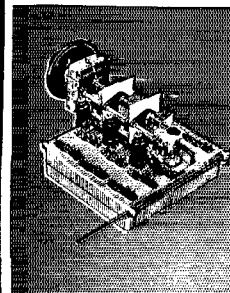

Now! An Even Greater

RCA-807

**HIGHER RATINGS
IMPROVED PERFORMANCE
MORE OUTPUT**

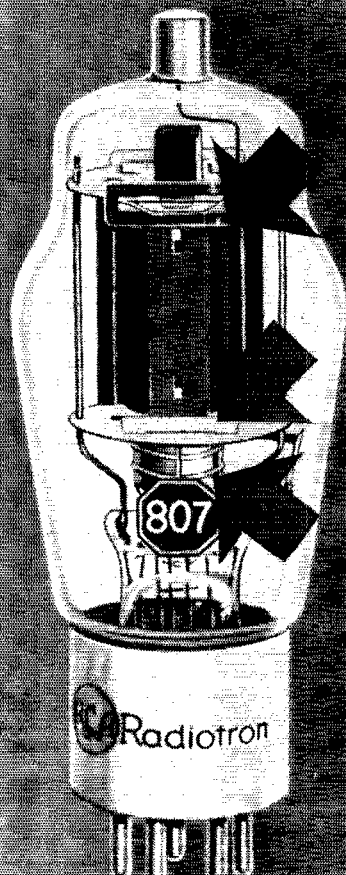

The maximum rated plate voltage is now increased to 600 volts for Class C telegraph service. This higher rating, made possible by a new electrode structure using ceramic insulation to isolate the plate, provides for a 50% greater input and an increasingly larger output.

New shielding gives greater stability and further lessens need for neutralization in those borderline cases. With the new 807, it is easier to avoid parasitics and self-oscillation.

These improvements in the RCA-807 are examples of the consistent RCA policy of improving existing tube types as well as introducing advanced new designs. The 807 is now an even better tube, yet the price remains the same... \$3.90 amateur's net.



for Amateur Radio

A Service of the Radio Corporation of America
RCA MANUFACTURING CO., INC., CAMDEN, N. J.

As usual at this time of year, a new National catalog is ready. Also, as usual, you will want a copy for it is free for the asking, and easily the season's best bargain. You will find several noteworthy new products between its covers, among them the new NC-80X and NC-81X. These two new receivers belong to the SW-3-FB-7 tradition, for they are thrifty, reliable and capable. Also they are a lot of fun to operate for reasons that will be evident when you get your hands on one. You will find a page from the new catalog describing them on the other side of this sheet. There are other new products, too, such as the multiple crystal holder; to say nothing of old products revamped, such as the receiving type sockets which have new conveniences and adaptability. And of course, there are the old reliables like the R-100 choke and the TM condensers, which are as well known as the trade-mark they carry.

Your dealer has a copy for you

NATIONAL *High Frequency* RECEIVERS

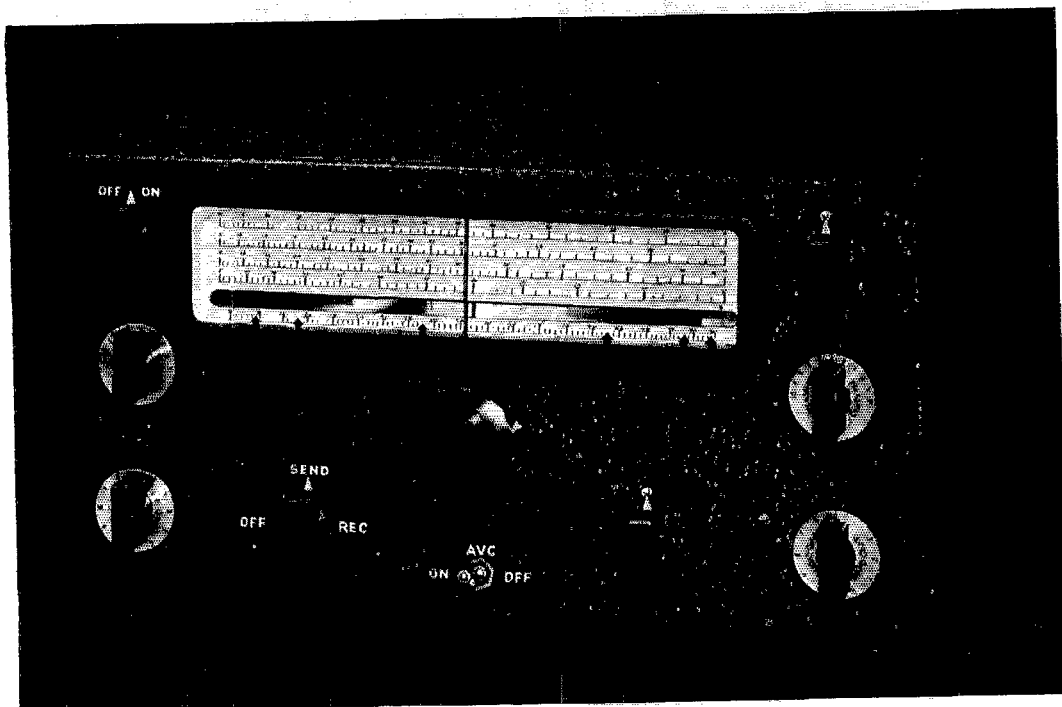

THE NC80X and NC81X

This is an inexpensive receiver having exceptional operating characteristics. Ten tubes are used in a high gain superheterodyne circuit as follows: 1st detector 6L7; HF osc. electron coupled, 6J7; three IF stages, 6K7's; linear 2nd detector, 6C5; amplified and delayed AVC, 6B8; panel controlled beat frequency oscillator, 6J7; beam power output, 25L6G; and rectifier, 25Z5. The IF amplifier is of entirely new design, operating at a frequency of 1560 KC, and providing a high order of image suppression, better, in fact, than that obtainable in many receivers having elaborate preselectors. The crystal filter (2nd IF stage) is truly remarkable in its performance, since selectivity is *continuously variable* between 400 cycles for single signal CW, and 5 KC for high quality broadcast. The range of the phasing circuit (heterodyne elimination) has been similarly extended. With such unusual characteristics, the crystal filter remains in the circuit at all times, simplifying tuning considerably. With the development of the 25L6G beam power tube having an undistorted output of 2 watts, it has become possible to design a high performance communication receiver operating with full efficiency on either AC or DC, 115 volts.

The tuning system, likewise entirely new, employs a multiple scale dial of the full-vision type,

accurately calibrated in megacycles. Several unusual features are incorporated, such as the mirror for overcoming parallax, the auxiliary linear scale (at the bottom), and the adjustable frequency markers, by means of which any particular stations, or frequencies, such as band limits, may be "logged" on the dial itself. Two vernier reduction ratios are available, 16 and 80 to 1, with a separate knob for each.

Automatic plug-in coils are used, controlled by a knob on the front panel, as in the NC-100. This arrangement has proven itself to be thoroughly reliable and efficient. The frequency coverage is continuous, except for a small gap at 1560 kc., from 550 kc. to 30 mc., in four ranges.

The NC-81X is a special amateur model covering the following bands only: 1.7-2.0 mc., 3.5-4.0 mc., 7.0-7.3 mc., 14.0-14.4 mc. and 28-30 mc. The dial is calibrated in megacycles.

NC-80X — complete with tubes, crystal filter, 8" PM speaker chassis, etc. for 115v. AC or DC. **Net Price, \$38.00**

NC-81X — Amateur Model, complete with tubes, crystal filter, 8" PM speaker chassis, etc. for 115v. AC or DC. **Net Price, \$88.00**

Note: Either of the above receivers can be supplied modified for Battery Operation 6v. heater, 135v. B-supply. To order, add "B" to symbol number. List prices are the same as the corresponding AC-DC model.

Type DCS-8 Metal Cabinet for 8" speaker, same finish as receiver. **Net Price, \$4.80**

Larger speakers or cabinets cannot be supplied for these receivers.

An engineering bulletin describing the above receivers in detail will be mailed on request.

16

NATIONAL COMPANY, INC., MALDEN, MASS